



EMB145

EMBRAER S.A.
12227-901 SAO JOSE DOS CAMPOS - S.P.
BRAZIL
PHONE: + 55 12 3927-7517
<http://www.embraer.com>
e-mail: distrib@embraer.com.br

AIRPORT PLANNING MANUAL

In connection with the use of this document, Embraer does not provide any express or implied warranties and expressly disclaims any warranty of merchantability or fitness for a particular purpose. This document contains trade secrets, confidential, proprietary information of Embraer and technical data subject to U.S. Export Administration Regulation ("EAR") and other countries export control laws and regulations. Diversion contrary to the EAR and other laws and regulations is strictly forbidden. The above restrictions may apply to data on all pages of this document.

APM-145/1100
30 MAY 1997

REVISION 15 - 23 SEPTEMBER 2019



EMBRAER S.A.

AV. BRIGADEIRO FARIA LIMA, 2.170 - PHONE: + 55 12 3927-7517
CEP 12.227-901 - SÃO JOSÉ DOS CAMPOS - SÃO PAULO - BRASIL
e-mail: distrib@embraer.com.br - <http://www.embraer.com>

TO: HOLDERS OF THE PUBLICATION No. A.P.M. 145/1100 - "AIRPORT PLANNING MANUAL", APPLICABLE TO EMB-145 AIRCRAFT MODELS.

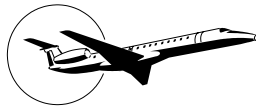
REVISION 15 DATED SEPTEMBER 23/19

HIGHLIGHTS

Pages which have been added, revised or deleted by the current revision are indicated by an asterisk, on the List of Effective Pages.

Remove and insert the affected pages as listed and enter this revision to the Record of Revision Sheet.

This issue incorporates all preceding Temporary Revisions (if any).

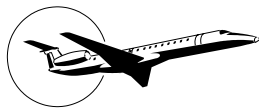


RECORD OF REVISIONS

REV No.	ISSUE DATE	DATE INSERTED	BY

REV No.	ISSUE DATE	DATE INSERTED	BY

RETAIN THIS RECORD IN THE FRONT OF MANUAL OR CHAPTER.
ON RECEIPT OF REVISIONS, INSERT REVISED PAGES IN THE MANUAL, AND ENTER REVISION NUMBER, DATE INSERTED AND INITIALS.



SERVICE BULLETIN LIST

SERVICE BULLETIN		MANUAL	
NUMBER	REV. No.	REV. No.	ISSUE DATE

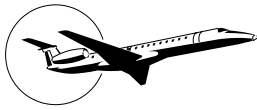
SERVICE BULLETIN		MANUAL	
NUMBER	REV. No.	REV. No.	ISSUE DATE



LIST OF EFFECTIVE PAGES

Original	May 30/97	* 3-5	Sep 23/19
Revision A	Feb 08/99	* 3-6	Sep 23/19
Revision B	Nov 18/99	* 3-7	Sep 23/19
Revision C	May 18/00	* 3-8	Sep 23/19
Revision D	Oct 18/00	* 3-9	Sep 23/19
Revision E	Apr 18/01	* 3-10	Sep 23/19
Revision F	Oct 10/01	* 3-11	Sep 23/19
Revision G	Apr 30/02	* 3-12	Sep 23/19
Revision H	Oct 18/02	* 3-13	Sep 23/19
Revision I	May 30/03	* 3-14	Sep 23/19
Revision J	Dec 29/03	* 3-15	Sep 23/19
Revision K	Aug 05/04	* 3-16	Sep 23/19
Revision L	Sep 28/05	* 3-17	Sep 23/19
Revision M	Jan 27/06	* 3-18	Sep 23/19
Revision N	Jan 19/07	* 3-19	Sep 23/19
Revision 15	Sep 23/19	* 3-20	Sep 23/19
* Title	Sep 23/19	* 3-21	Sep 23/19
List of Effective Pages		* 3-22	Sep 23/19
* 1	Sep 23/19	* 4-1	Sep 23/19
* 2	Sep 23/19	* 4-2	Sep 23/19
Table of Contents		* 4-3	Sep 23/19
* 1	Sep 23/19	* 4-4	Sep 23/19
* 2	Sep 23/19	* 4-5	Sep 23/19
* 1-1	Sep 23/19	* 4-6	Sep 23/19
* 1-2	Sep 23/19	* 4-7	Sep 23/19
* 2-1	Sep 23/19	* 4-8	Sep 23/19
* 2-2	Sep 23/19	* 4-9	Sep 23/19
* 2-3	Sep 23/19	* 4-10	Sep 23/19
* 2-4	Sep 23/19	* 4-11	Sep 23/19
* 2-5	Sep 23/19	* 4-12	Sep 23/19
* 2-6	Sep 23/19	* 5-1	Sep 23/19
* 2-7	Sep 23/19	* 5-2	Sep 23/19
* 2-8	Sep 23/19	* 5-3	Sep 23/19
* 2-9	Sep 23/19	* 5-4	Sep 23/19
* 2-10	Sep 23/19	* 5-5	Sep 23/19
* 2-11	Sep 23/19	* 5-6	Sep 23/19
* 2-12	Sep 23/19	* 5-7	Sep 23/19
* 2-13	Sep 23/19	* 5-8	Sep 23/19
* 2-14	Sep 23/19	* 5-9	Sep 23/19
* 2-15	Sep 23/19	* 5-10	Sep 23/19
* 2-16	Sep 23/19	* 5-11	Sep 23/19
* 2-17	Sep 23/19	* 5-12	Sep 23/19
* 2-18	Sep 23/19	* 5-13	Sep 23/19
* 3-1	Sep 23/19	* 5-14	Sep 23/19
* 3-2	Sep 23/19	* 5-15	Sep 23/19
* 3-3	Sep 23/19	* 5-16	Sep 23/19
* 3-4	Sep 23/19	* 6-1	Sep 23/19

Pages revised or added by the current revision are indicated by an asterisk (*). Pages deleted by the current revision are indicated by * (del). Pages deleted by the previous revision are indicated by (del).



LIST OF EFFECTIVE PAGES

* 6-2	Sep 23/19	* 7-37	Sep 23/19
* 6-3	Sep 23/19	* 7-38	Sep 23/19
* 6-4	Sep 23/19	* 7-39	Sep 23/19
* 6-5	Sep 23/19	* 7-40	Sep 23/19
* 6-6	Sep 23/19	* 7-41	Sep 23/19
* 6-7	Sep 23/19	* 7-42	Sep 23/19
* 6-8	Sep 23/19	* 7-43	Sep 23/19
* 6-9	Sep 23/19	* 7-44	Sep 23/19
* 6-10	Sep 23/19	* 7-45	Sep 23/19
* 6-11	Sep 23/19	* 7-46	Sep 23/19
* 6-12	Sep 23/19	* 7-47	Sep 23/19
* 7-1	Sep 23/19	* 7-48	Sep 23/19
* 7-2	Sep 23/19	* 7-49	Sep 23/19
* 7-3	Sep 23/19	* 7-50	Sep 23/19
* 7-4	Sep 23/19	* 7-51	Sep 23/19
* 7-5	Sep 23/19	* 7-52	Sep 23/19
* 7-6	Sep 23/19	* 8-1	Sep 23/19
* 7-7	Sep 23/19	* 8-2	Sep 23/19
* 7-8	Sep 23/19	* 9-1	Sep 23/19
* 7-9	Sep 23/19	* 9-2	Sep 23/19
* 7-10	Sep 23/19	* 9-3	Sep 23/19
* 7-11	Sep 23/19	* 9-4	Sep 23/19
* 7-12	Sep 23/19	* 9-5	Sep 23/19
* 7-13	Sep 23/19	* 9-6	Sep 23/19
* 7-14	Sep 23/19			
* 7-15	Sep 23/19			
* 7-16	Sep 23/19			
* 7-17	Sep 23/19			
* 7-18	Sep 23/19			
* 7-19	Sep 23/19			
* 7-20	Sep 23/19			
* 7-21	Sep 23/19			
* 7-22	Sep 23/19			
* 7-23	Sep 23/19			
* 7-24	Sep 23/19			
* 7-25	Sep 23/19			
* 7-26	Sep 23/19			
* 7-27	Sep 23/19			
* 7-28	Sep 23/19			
* 7-29	Sep 23/19			
* 7-30	Sep 23/19			
* 7-31	Sep 23/19			
* 7-32	Sep 23/19			
* 7-33	Sep 23/19			
* 7-34	Sep 23/19			
* 7-35	Sep 23/19			
* 7-36	Sep 23/19			

Pages revised or added by the current revision are indicated by an asterisk (*). Pages deleted by the current revision are indicated by * (del). Pages deleted by the previous revision are indicated by (del).

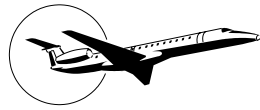


TABLE OF CONTENTS

Section	Page
1. INTRODUCTION	1-1
1.1 Purpose	1-1
1.2 Scope	1-1
2. AIRPLANE DESCRIPTION	2-1
2.1 General Airplane Characteristics	2-1
2.2 Airplane Dimensions	2-2
2.3 Ground Clearances	2-6
2.4 Interior Arrangements	2-10
2.5 Passenger Cabin Cross-Section	2-15
2.6 Lower Compartment Containers	2-16
2.7 Door Clearances	2-17
3. AIRPLANE PERFORMANCE	3-1
3.1 General Information	3-1
3.2 Payload x Range	3-2
3.3 FAR Takeoff Runway Length Requirements	3-11
3.4 FAR Landing Runway Length Requirements	3-19
4. GROUND MANEUVERING	4-1
4.1 General Information	4-1
4.2 Turning Radii - No Slip Angle	4-2
4.3 Minimum Turning Radii	4-4
4.4 Visibility from Cockpit in Static Position	4-7
4.5 Runway and Taxiway Turn Paths	4-8
4.6 Runway Holding Bay	4-11
5. TERMINAL SERVICING	5-1
5.1 General Information	5-1
5.2 Air Terminal Operation - Turnaround Station	5-4
5.3 Air Terminal Operation - Enroute Station	5-5
5.4 Ground Servicing Connections EMB-145	5-6
5.5 Engine Starting Pneumatic Requirements	5-12
5.6 Ground Pneumatic Power Requirements	5-14
5.7 Conditioned Air Requirements	5-15
5.8 Ground Towing Requirements	5-16
6. OPERATING CONDITIONS	6-1
6.1 Engine Exhaust Velocities and Temperatures	6-2
6.2 Airport and Community Noise	6-8
6.3 Hazard Areas	6-11
7. PAVEMENT DATA	7-1
7.1 General Information	7-1
7.2 Footprint	7-4
7.3 Maximum Pavement Loads	7-5
7.4 Landing Gear Loading on Pavement	7-6

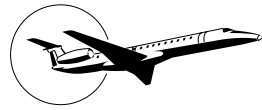
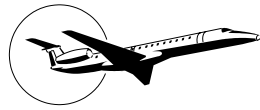


TABLE OF CONTENTS

Section	Page
7.5 Flexible Pavement Requirements - US Army Corps of Engineers Design Method ..	7-10
7.6 Flexible Pavement Requirements - LCN Method	7-16
7.7 Rigid Pavement Requirements - Portland Cement Association Design Method	7-22
7.8 Rigid Pavement Requirements - LCN Method	7-28
7.9 ACN/PCN Reporting System - Flexible and Rigid Pavements	7-38
8. POSSIBLE EMB-145 DERIVATIVE AIRPLANES	8-1
9. EMB-145 SCALE DRAWINGS	9-1
9.1 EMB-145 Scale: 1 Inch Equals 32 Feet	9-2
9.2 EMB-145 Scale: 1 Inch Equals 50 Feet	9-3
9.3 EMB-145 Scale: 1 Inch Equals 100 Feet	9-4
9.4 EMB-145 Scale: 1 to 500	9-5
9.5 EMB-145 Scale: 1 to 1000	9-6



1. INTRODUCTION

1.1 Purpose

This document provides airplane characteristics for general airport planning. Since the operational practices vary among the airlines, specific data should be coordinated with the using airlines before the facility design is made.

EMBRAER should be contacted for any additional information required.

1.2 Scope

This document complies with NAS3601, revision 6.

It provides characteristics of the EMB-145EP, EMB-145ER, EMB-145EU, EMB-145MP, EMB-145MK, EMB-145LR, EMB-145LU, and EMB-145XR aircraft models for airport operators, airlines, and engineering consultant organizations. Since the airplane changes and available options may alter the information, the data presented herein must be regarded as subject to change.

For further information, contact:

■ EMBRAER S.A.

Av. Brigadeiro Faria Lima, 2170

■ CEP 12227-901

São José dos Campos, SP - BRASIL

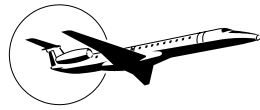
Att. Technical Publications

■ Phone: + 55 12 3927-7517

e-mail: distrib@embraer.com.br



THIS PAGE LEFT BLANK INTENTIONALLY



2. AIRPLANE DESCRIPTION

2.1 General Airplane Characteristics

The airplane is an all-metal semimonocoque-type structure, low-winged, T-tailed, pressurized airplane featuring a retractable twin-wheeled, tricycle-type landing gear system and two high bypass ratio rear-mounted Rolls Royce AE 3007 turbofan engines. The airplane has convenient accommodations for a pilot, a copilot, and a flight observer. The typical passenger configuration consists of three seats abreast, with front galley and rear toilet. Accommodation for a second flight attendant is available as an option.

2.1.1 Definitions

Maximum Design Taxi Weight (MTW): Maximum weight for ground maneuver as limited by the aircraft strength and airworthiness requirements. (It includes weight of taxi and run-up fuel).

Maximum Design Landing Weight (MLW): Maximum weight for landing as limited by the aircraft strength and airworthiness requirements.

Maximum Design Takeoff Weight (MTOW): Maximum weight for takeoff as limited by the aircraft strength and airworthiness requirements. (This is the maximum weight at the start of the takeoff run).

Operating Empty Weight (OEW): Weight of the structure, power plant, furnishings, systems, unusable fuel, and other unusable propulsion agents, as well as other items of equipment that are considered an integral part of a particular airplane configuration. Also included are certain standard units, crew and crew baggage, catering, navigation kit, and suppliers necessary for full operations, excluding usable fuel and payload.

Maximum Design Zero Fuel Weight (MZFW): Maximum weight allowed before usable fuel and other specified usable agents are loaded in defined sections of the aircraft as limited by the strength and airworthiness requirements.

Maximum Payload: Maximum design zero fuel weight minus operational empty weight.

Maximum Seating Capacity: The maximum number of passengers specifically certified or anticipated for certification.

Maximum Cargo Volume: The maximum space available for cargo.

Usable Fuel: Fuel available for the aircraft propulsion.

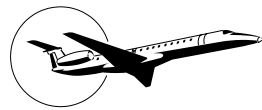


Table 2.1.1.1 - EMB-145 Airplane General Characteristics

DESIGN WEIGHTS		MODELS							
		ER	EU	EP	LR	LU	MP	MK	XR
Maximum Design Taxi Weight	lb	45636	44291	46495	48722	48700	46495	44291	53352
	kg	20700	20090	21090	22100	22090	21090	20090	24200
Maximum Design Landing Weight ^[3]	lb	41226	41226	41226	42549	42549	42549	42549	44092
	kg	18700	18700	18700	19300	19300	19300	19300	20000
Maximum Design Takeoff Weight ^[3]	lb	45415	44070	46275	48502	48480	46275	44070	53131
	kg	20600	19990	20990	22000	21990	20990	19990	24100
Operating Empty Weight ^[1]	lb	26339	26339	26339	26707	26707	26539	26539	27758
	kg	11947	11947	11947	12114	12114	12038	12038	12591
Maximum Design Zero Fuel Weight ^[2] ^[3]	lb	37699	37699	37699	39463	39463	39463	39463	40786
	kg	17100	17100	17100	17900	17900	17900	17900	18500
Maximum Payload ^[1]	lb	11359	11359	11359	12755	12755	12923	12923	13027
	kg	5153	5153	5153	5786	5786	5862	5862	5909
Maximum Seating Capacity	PAS-SEN-GERS	50	50	50	50	50	50	50	50
Maximum Cargo Volume	ft ³	325	325	325	325	325	325	325	325
	m ³	9.2	9.2	9.2	9.2	9.2	9.2	9.2	9.2
Usable Fuel ^[4]	lb	9202	9202	9202	11435	11435	9202	9202	13199
	kg	4173	4173	4173	5187	5187	4173	4173	6032
	US GAL.	1360	1360	1360	1690	1690	1360	1360	1950
	LITERS	5146	5146	5146	6396	6396	5146	5146	7438

[1] Standard configuration (weights may vary according to optional equipment installed or interior layouts).

[2] For aircraft POST-MOD. S.B. 145-53-0064, consider MZFW = 17350 kg (38250 lb).

[3] For aircraft POST-MOD. S.B. 145-53-0068, consider MZFW = 18400 kg (40564 lb), MTOW= 22600 kg (49823 lb), and MLW= 19800 kg (43651 lb).

[4] Adopted fuel density of 0.811 kg/l (6.77 lb/US gal.).

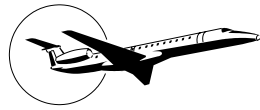
2.2 Airplane Dimensions

2.2.1 External Dimensions

Overall span (EMB-145EP/ER/EU/MP/MK/LR/LU)	20.04 m (65 ft 9 in)
Overall span (EMB-145XR)	21.00 m (69 ft 11 in)
Height (maximum)	6.75 m (22 ft 2 in)
Overall length	29.87 m (98 ft 0 in)

2.2.2 Wing

Reference area	51.18 m ² (551 ft ²)
Reference aspect ratio	7.8



2.2.3 Fuselage

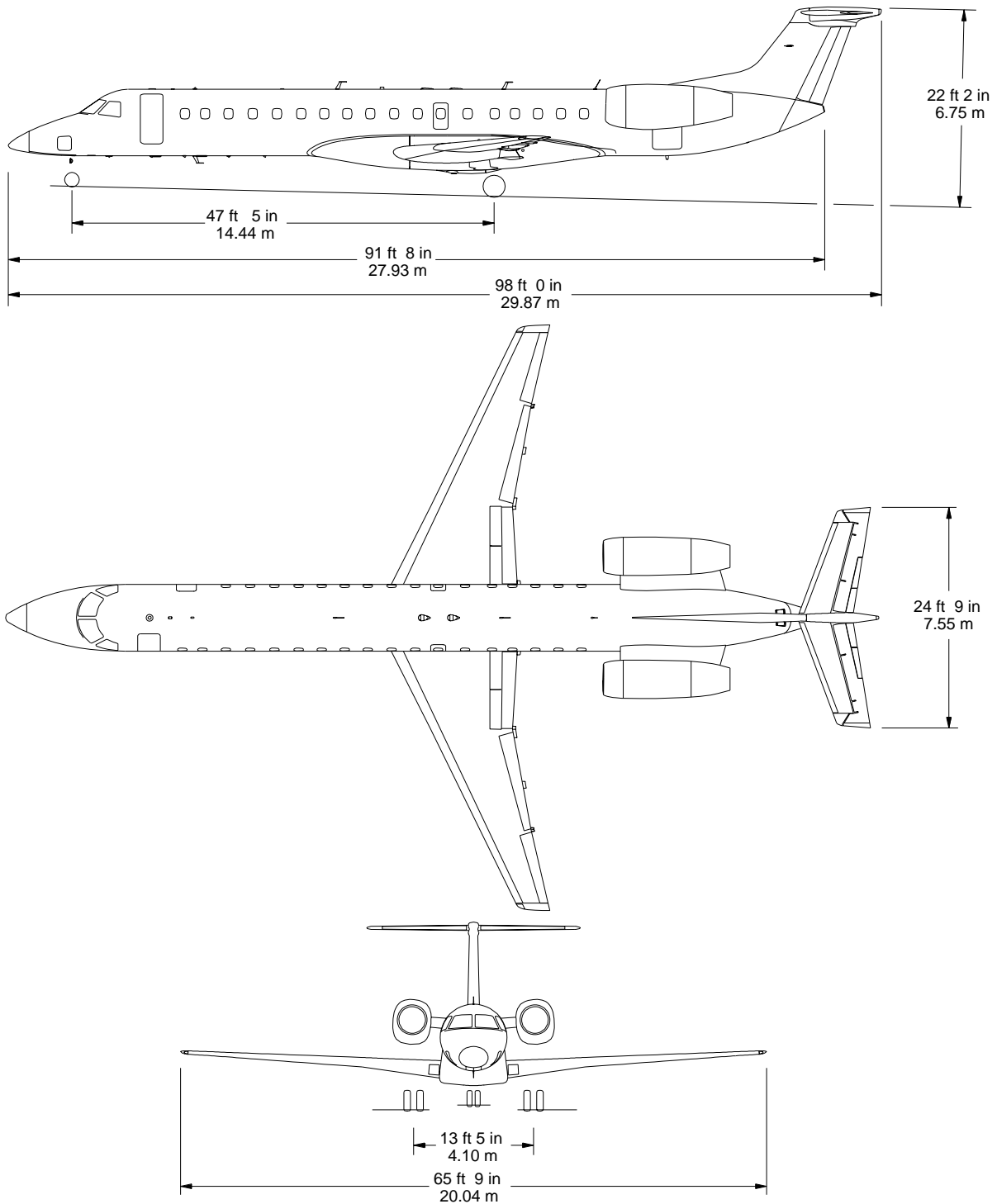
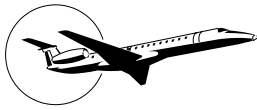
Total Length	27.93 m (91 ft 8 in)
Length of pressurized section	23.22 m (76 ft 2 in)
Outside diameter	2.28 m (7 ft 6 in)

2.2.4 Horizontal Tail

Span	7.55 m (24 ft 9 in)
Area	11.20 m ² (120.6 ft ²)

2.2.5 Vertical Tail

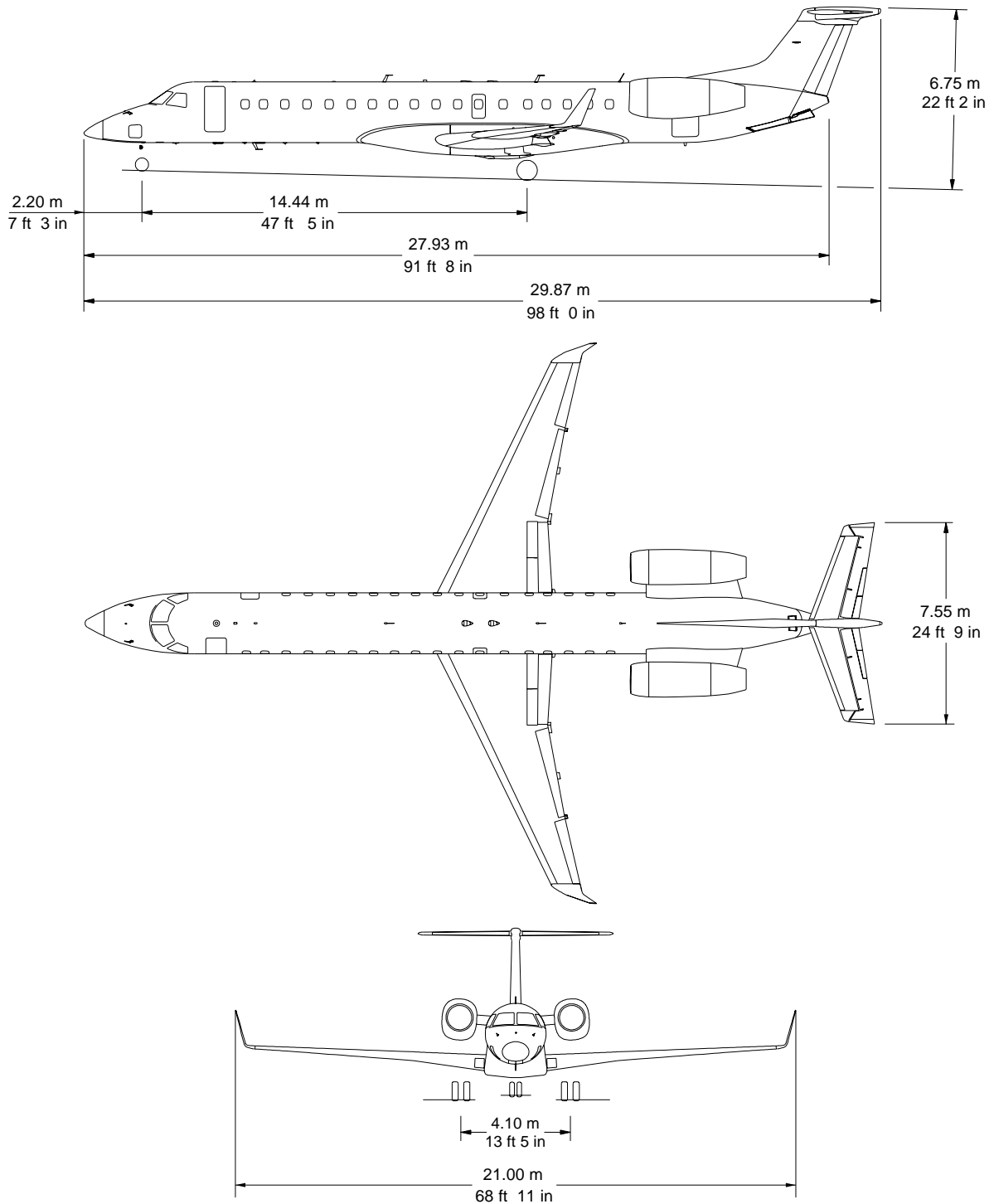
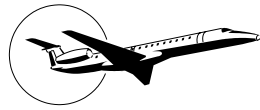
Reference area	7.20 m ² (77.5 ft ²)
----------------------	---



EMB-145 EP/ER/EU/MP/MK/LR/LU

145APM000008.MCE A

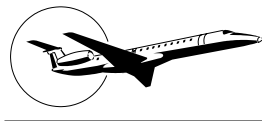
Figure 2.2.1 - EMB-145 Airplane General Dimensions



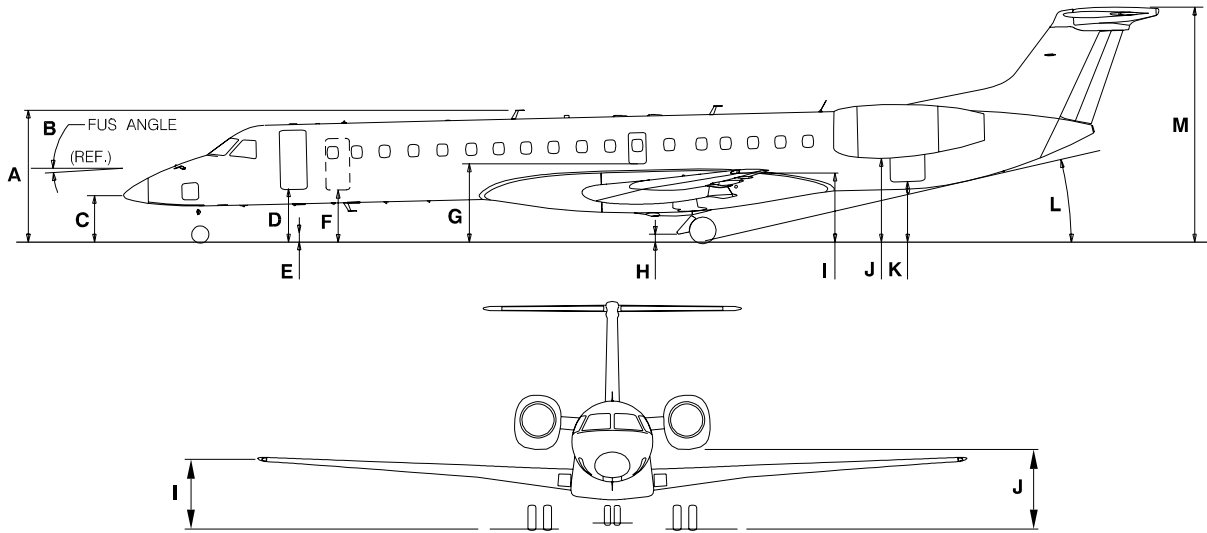
EMB-145XR

145APM020272.MCE A

Figure 2.2.2 - EMB-145 Airplane General Dimensions



2.3 Ground Clearances

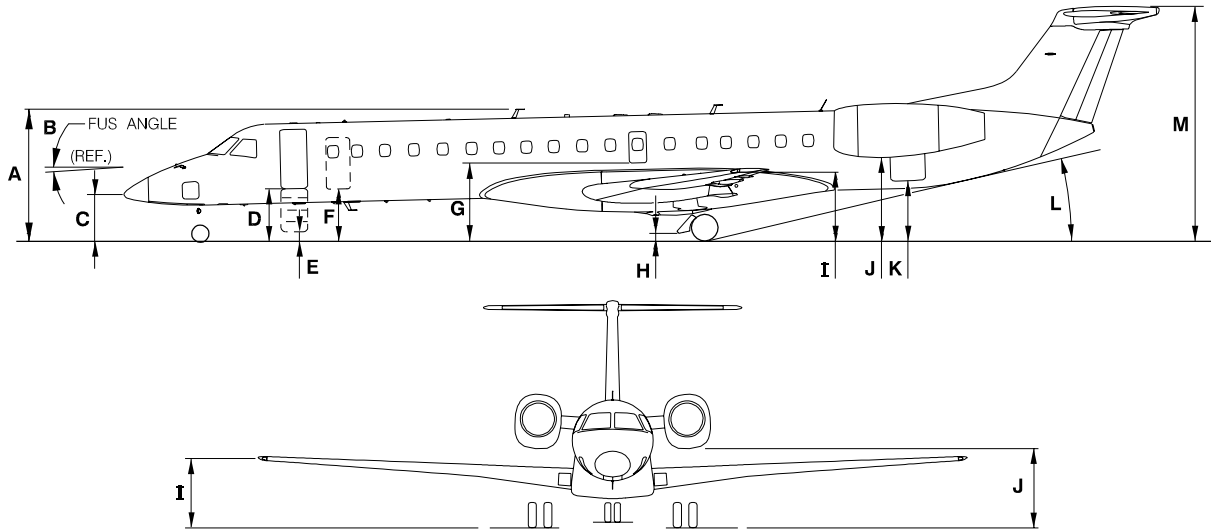
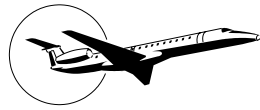


EMB-145ER/EP/EU - GROUND CLEARANCE

WEIGHT	CG (%MAC)	ANTENNA	FUS ANGLE (DEG)	NOSE	MAIN DOOR (A/C FLOOR)	MAIN DOOR (OPEN, 1ST STEP)	EMERGENCY / SERVICE DOOR	EMERGENCY EXIT	MAIN LDG DOOR	WING TIP	NACELLE	BAGGAGE DOOR	TAILSKID ANGULAR CLEARANCE (DEG)	TAIL BOOM
		A	B	C	D	E	F	G	H	I	J	K	L	M
21090kg 46495lb	17.4	3.748m 12ft 3.6in	-1.27	1.313m 4ft 3.7in	1.480m 4ft 10.3in	0.287m 0ft 11.3in	1.479m 4ft 10.2in	2.202m 7ft 2.7in	0.337m 1ft 1.3in	1.930m 6ft 4.0in	2.345m 7ft 8.3in	1.696m 5ft 6.8in	12.1	6.678m 21ft 10.9in
21090kg 46495lb	43.0	3.765m 12ft 4.2in	-1.00	1.383m 4ft 6.4in	1.527m 5ft 0.1in	0.334m 1ft 1.1in	1.520m 4ft 11.8in	2.202m 7ft 2.7in	0.331m 1ft 1.0in	1.916m 6ft 3.4in	2.312m 7ft 7.0in	1.660m 5ft 5.4in	11.8	6.616m 21ft 8.5in
20990kg 46275lb	17.4	3.748m 12ft 3.6in	-1.27	1.313m 4ft 3.7in	1.480m 4ft 10.3in	0.288m 0ft 11.3in	1.480m 4ft 10.3in	2.203m 7ft 2.7in	0.338m 1ft 1.3in	1.931m 6ft 4.0in	2.346m 7ft 8.4in	1.697m 5ft 6.8in	12.1	6.679m 21ft 11.0in
20990kg 46275lb	43.0	3.766m 12ft 4.3in	-1.00	1.383m 4ft 6.4in	1.527m 5ft 0.1in	0.335m 1ft 1.2in	1.521m 4ft 11.9in	2.203m 7ft 2.7in	0.332m 1ft 1.1in	1.917m 6ft 3.5in	2.313m 7ft 7.1in	1.661m 5ft 5.4in	11.8	6.616m 21ft 8.5in
20700kg 45635lb	17.4	3.750m 12ft 3.6in	-1.27	1.313m 4ft 3.7in	1.481m 4ft 10.3in	0.289m 0ft 11.4in	1.481m 4ft 10.3in	2.205m 7ft 2.8in	0.340m 1ft 1.4in	1.933m 6ft 4.1in	2.349m 7ft 8.5in	1.700m 5ft 6.9in	12.1	6.683m 21ft 11.1in
20700kg 45635lb	43.0	3.768m 12ft 4.3in	-1.00	1.385m 4ft 6.5in	1.529m 5ft 0.2in	0.336m 1ft 1.2in	1.522m 4ft 11.9in	2.205m 7ft 2.8in	0.334m 1ft 1.1in	1.919m 6ft 3.6in	2.315m 7ft 7.1in	1.663m 5ft 5.5in	11.8	6.619m 21ft 8.5in
20600kg 45415lb	17.4	3.750m 12ft 3.6in	-1.27	1.314m 4ft 3.7in	1.481m 4ft 10.3in	0.289m 0ft 11.4in	1.481m 4ft 10.3in	2.205m 7ft 2.8in	0.341m 1ft 1.4in	1.934m 6ft 4.1in	2.350m 7ft 8.5in	1.701m 5ft 7.0in	12.1	6.684m 21ft 11.1in
20600kg 45415lb	43.0	3.768m 12ft 4.3in	-1.00	1.385m 4ft 6.5in	1.529m 5ft 0.2in	0.337m 1ft 1.3in	1.523m 4ft 12.0in	2.205m 7ft 2.8in	0.335m 1ft 1.2in	1.920m 6ft 3.6in	2.316m 7ft 7.2in	1.664m 5ft 5.5in	11.8	6.620m 21ft 8.6in
20090kg 44291lb	16.4	3.753m 12ft 3.8in	-1.29	1.314m 4ft 3.7in	1.483m 4ft 10.4in	0.291m 0ft 11.5in	1.483m 4ft 10.4in	2.209m 7ft 3.0in	0.345m 1ft 1.6in	1.938m 6ft 4.3in	2.355m 7ft 8.7in	1.706m 5ft 7.2in	12.2	6.691m 21ft 11.4in
20090kg 44291lb	43.0	3.772m 12ft 4.5in	-1.00	1.388m 4ft 6.6in	1.533m 5ft 0.4in	0.340m 1ft 1.4in	1.526m 5ft 0.1in	2.209m 7ft 3.0in	0.339m 1ft 1.3in	1.923m 6ft 3.7in	2.320m 7ft 7.3in	1.668m 5ft 5.7in	11.8	6.624m 21ft 8.8in
19990kg 44070lb	16.4	3.754m 12ft 3.8in	-1.29	1.315m 4ft 3.8in	1.484m 4ft 10.4in	0.291m 0ft 11.5in	1.483m 4ft 10.4in	2.210m 7ft 3.0in	0.345m 1ft 1.6in	1.939m 6ft 4.3in	2.356m 7ft 8.8in	1.707m 5ft 7.2in	12.2	6.692m 21ft 11.5in
19990kg 44070lb	43.0	3.772m 12ft 4.5in	-1.00	1.389m 4ft 6.7in	1.533m 5ft 0.4in	0.341m 1ft 1.4in	1.527m 5ft 0.1in	2.210m 7ft 3.0in	0.339m 1ft 1.3in	1.924m 6ft 3.7in	2.321m 7ft 7.4in	1.669m 5ft 5.7in	11.8	6.625m 21ft 8.8in
18700kg 41226lb	15.1	3.762m 12ft 4.1in	-1.32	1.317m 4ft 3.9in	1.488m 4ft 10.6in	0.296m 0ft 11.7in	1.489m 4ft 10.6in	2.220m 7ft 3.4in	0.356m 1ft 2.0in	1.951m 6ft 4.8in	2.370m 7ft 9.3in	1.731m 5ft 8.1in	12.3	6.709m 22ft 0.1in
18700kg 41226lb	43.0	3.782m 12ft 4.9in	-1.01	1.397m 4ft 7.0in	1.542m 5ft 0.7in	0.349m 1ft 1.7in	1.536m 5ft 0.5in	2.220m 7ft 3.4in	0.350m 1ft 1.8in	1.935m 6ft 4.2in	2.332m 7ft 7.8in	1.680m 5ft 6.1in	11.9	6.637m 21ft 9.3in
15500kg 34172lb	12.0	3.787m 12ft 5.1in	-1.41	1.324m 4ft 4.1in	1.504m 4ft 11.2in	0.311m 1ft 0.2in	1.506m 4ft 11.3in	2.251m 7ft 4.6in	0.389m 1ft 3.3in	1.986m 6ft 6.2in	2.411m 7ft 10.9in	1.764m 5ft 9.4in	12.6	6.761m 22ft 2.2in
13000kg 28660lb	12.0	3.815m 12ft 6.2in	-1.48	1.338m 4ft 4.7in	1.523m 4ft 12.0in	0.331m 1ft 1.0in	1.527m 5ft 0.1in	2.283m 7ft 5.9in	0.423m 1ft 4.7in	2.022m 6ft 7.6in	2.452m 7ft 0.5in	1.807m 5ft 11.1in	12.9	6.810m 22ft 4.1in
13000kg 28660lb	43.0	3.842m 12ft 7.3in	-1.05	1.349m 4ft 9.0in	1.598m 5ft 2.9in	0.405m 1ft 3.9in	1.592m 5ft 2.7in	2.283m 7ft 5.9in	0.413m 1ft 4.3in	2.000m 6ft 6.7in	2.400m 7ft 10.5in	1.748m 5ft 8.8in	12.4	6.709m 22ft 0.1in
12000kg 26455lb	40.0	3.852m 12ft 7.7in	-1.14	1.442m 4ft 8.8in	1.598m 5ft 2.9in	0.406m 1ft 4.0in	1.595m 5ft 2.8in	2.298m 7ft 6.5in	0.430m 1ft 4.9in	2.019m 6ft 7.5in	2.425m 7ft 11.5in	1.775m 5ft 9.9in	12.6	6.744m 22ft 1.5in

APM020251.MCE A

**Figure 2.3.1 - Ground Clearances
Sheet 1**

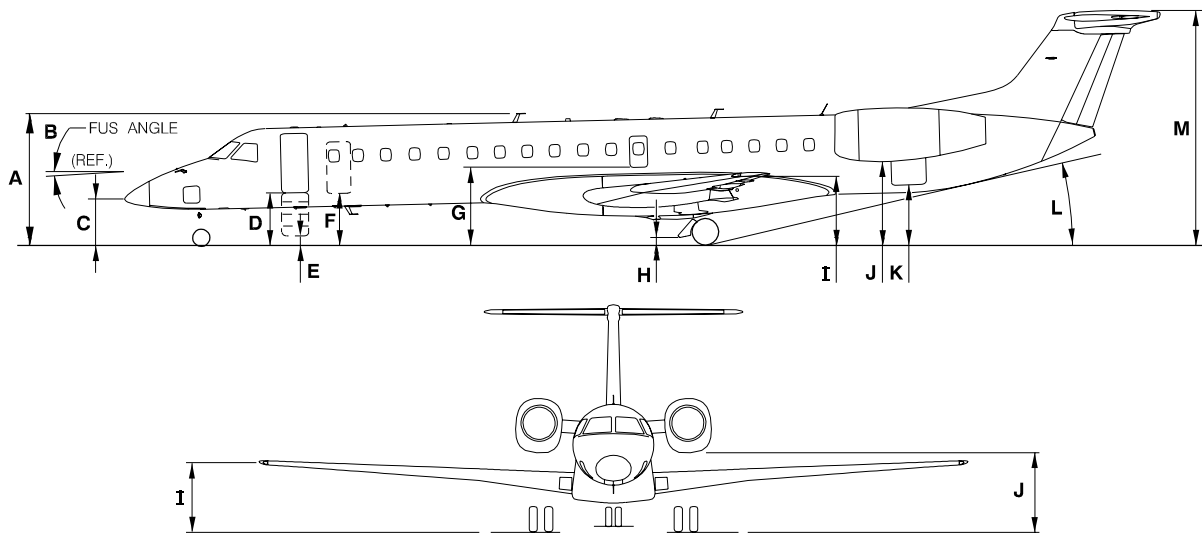
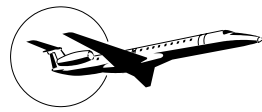


EMB-145LR/LU - GROUND CLEARANCE

WEIGHT	CG (%MAC)	ANTENNA	FUS ANGLE (DEG)	NOSE	MAIN DOOR (A/C FLOOR)	MAIN DOOR (OPEN, 1ST STEP)	EMERGENCY/ SERVICE DOOR	EMERGENCY EXIT	MAIN LDG DOOR	WING TIP	NACELLE	BAGGAGE DOOR	TAILSKID ANGULAR CLEARANCE (DEG)	TAIL BOOM
		A	B	C	D	E	F	G	H	I	J	K	L	M
22100kg 48722lb	18.4	3.745m 12ft 3.4in	-1.26	1.311m 4ft 3.6in	1.477m 4ft 10.1in	0.285m 0ft 11.2in	1.477m 4ft 10.1in	2.194m 7ft 2.4in	0.334m 1ft 1.1in	1.923m 6ft 3.7in	2.342m 7ft 8.2in	1.693m 5ft 6.7in	12.1	6.675m 21ft 10.8in
22100kg 48722lb	39.5	3.757m 12ft 3.9in	-1.06	1.363m 4ft 5.7in	1.512m 4ft 11.5in	0.320m 1ft 0.6in	1.507m 4ft 11.3in	2.194m 7ft 2.4in	0.329m 1ft 1.0in	1.913m 6ft 3.3in	2.317m 7ft 7.2in	1.665m 5ft 5.6in	11.8	6.627m 21ft 8.9in
22090kg 48700lb	18.4	3.745m 12ft 3.4in	-1.26	1.311m 4ft 3.6in	1.477m 4ft 10.1in	0.285m 0ft 11.2in	1.477m 4ft 10.1in	2.194m 7ft 2.4in	0.334m 1ft 1.1in	1.923m 6ft 3.7in	2.342m 7ft 8.2in	1.693m 5ft 6.7in	12.1	6.675m 21ft 10.8in
22090kg 48700lb	39.5	3.757m 12ft 3.9in	-1.06	1.363m 4ft 5.7in	1.512m 4ft 11.5in	0.320m 1ft 0.6in	1.507m 4ft 11.3in	2.194m 7ft 2.4in	0.329m 1ft 1.0in	1.913m 6ft 3.3in	2.317m 7ft 7.2in	1.665m 5ft 5.6in	11.8	6.627m 21ft 8.9in
22000kg 48502lb	18.4	3.745m 12ft 3.4in	-1.26	1.311m 4ft 3.6in	1.478m 4ft 10.2in	0.285m 0ft 11.2in	1.477m 4ft 10.1in	2.195m 7ft 2.4in	0.335m 1ft 1.2in	1.924m 6ft 3.7in	2.342m 7ft 8.2in	1.694m 5ft 6.7in	12.1	6.676m 21ft 10.8in
22000kg 48502lb	39.5	3.758m 12ft 4.0in	-1.06	1.363m 4ft 5.7in	1.513m 4ft 11.6in	0.320m 1ft 0.6in	1.507m 4ft 11.3in	2.195m 7ft 2.4in	0.330m 1ft 1.0in	1.913m 6ft 3.3in	2.318m 7ft 7.3in	1.666m 5ft 5.6in	11.8	6.628m 21ft 8.9in
21990kg 48480lb	18.4	3.745m 12ft 3.4in	-1.26	1.311m 4ft 3.6in	1.478m 4ft 10.2in	0.285m 0ft 11.2in	1.477m 4ft 10.1in	2.195m 7ft 2.4in	0.335m 1ft 1.2in	1.924m 6ft 3.7in	2.343m 7ft 8.2in	1.694m 5ft 6.7in	12.1	6.676m 21ft 10.8in
21990kg 48480lb	39.5	3.758m 12ft 4.0in	-1.06	1.363m 4ft 5.7in	1.513m 4ft 11.6in	0.320m 1ft 0.6in	1.508m 4ft 11.4in	2.195m 7ft 2.4in	0.330m 1ft 1.0in	1.913m 6ft 3.3in	2.318m 7ft 7.3in	1.666m 5ft 5.6in	11.8	6.628m 21ft 8.9in
19300kg 42549lb	15.6	3.761m 12ft 4.1in	-1.32	1.315m 4ft 3.8in	1.487m 4ft 10.5in	0.294m 0ft 11.6in	1.487m 4ft 10.5in	2.214m 7ft 3.2in	0.355m 1ft 2.0in	1.946m 6ft 4.6in	2.368m 7ft 9.2in	1.720m 5ft 7.7in	12.3	6.708m 22ft 0.1in
19300kg 42549lb	39.5	3.775m 12ft 4.6in	-1.08	1.376m 4ft 6.2in	1.527m 5ft 0.1in	0.335m 1ft 1.2in	1.523m 4ft 12.0in	2.214m 7ft 3.2in	0.349m 1ft 1.7in	1.933m 6ft 4.1in	2.339m 7ft 8.1in	1.720m 5ft 6.5in	12.0	6.652m 21ft 9.9in
17100kg 37699lb	43.0	3.797m 12ft 5.5in	-1.04	1.407m 4ft 7.4in	1.554m 5ft 1.2in	0.362m 1ft 2.3in	1.549m 5ft 1.0in	2.233m 7ft 3.9in	0.367m 1ft 2.4in	1.950m 6ft 4.8in	2.353m 7ft 8.6in	1.701m 5ft 7.0in	12.1	6.661m 21ft 10.2in
15500kg 34172lb	12.0	3.789m 12ft 5.2in	-1.42	1.324m 4ft 4.1in	1.504m 4ft 11.2in	0.312m 1ft 0.3in	1.507m 4ft 11.3in	2.249m 7ft 4.5in	0.392m 1ft 3.4in	1.987m 6ft 6.2in	2.416m 7ft 11.1in	1.769m 5ft 9.6in	12.7	6.767m 22ft 2.4in
13400kg 29542lb	12.0	3.818m 12ft 6.3in	-1.48	1.335m 4ft 4.6in	1.520m 4ft 11.8in	0.328m 1ft 0.9in	1.524m 4ft 12.0in	2.276m 7ft 5.6in	0.420m 1ft 4.5in	2.016m 6ft 7.4in	2.450m 8ft 0.5in	1.804m 5ft 11.0in	12.9	6.807m 22ft 4.0in
13400kg 29542lb	43.0	3.839m 12ft 7.1in	-1.06	1.443m 4ft 8.8in	1.593m 5ft 2.7in	0.400m 1ft 3.7in	1.588m 5ft 2.5in	2.275m 7ft 5.6in	0.411m 1ft 4.2in	1.994m 6ft 6.5in	2.398m 7ft 10.4in	1.747m 5ft 8.8in	12.4	6.709m 22ft 0.1in
12400kg 27337lb	30.0	3.835m 12ft 7.0in	-1.32	1.389m 4ft 6.7in	1.561m 5ft 1.5in	0.368m 1ft 2.5in	1.561m 5ft 1.5in	2.288m 7ft 6.1in	0.429m 1ft 4.9in	2.021m 6ft 7.6in	2.443m 8ft 0.2in	1.795m 5ft 10.7in	12.8	6.783m 22ft 3.0in

APM020252.MCE A

*Figure 2.3.1 - Ground Clearances
Sheet 2*

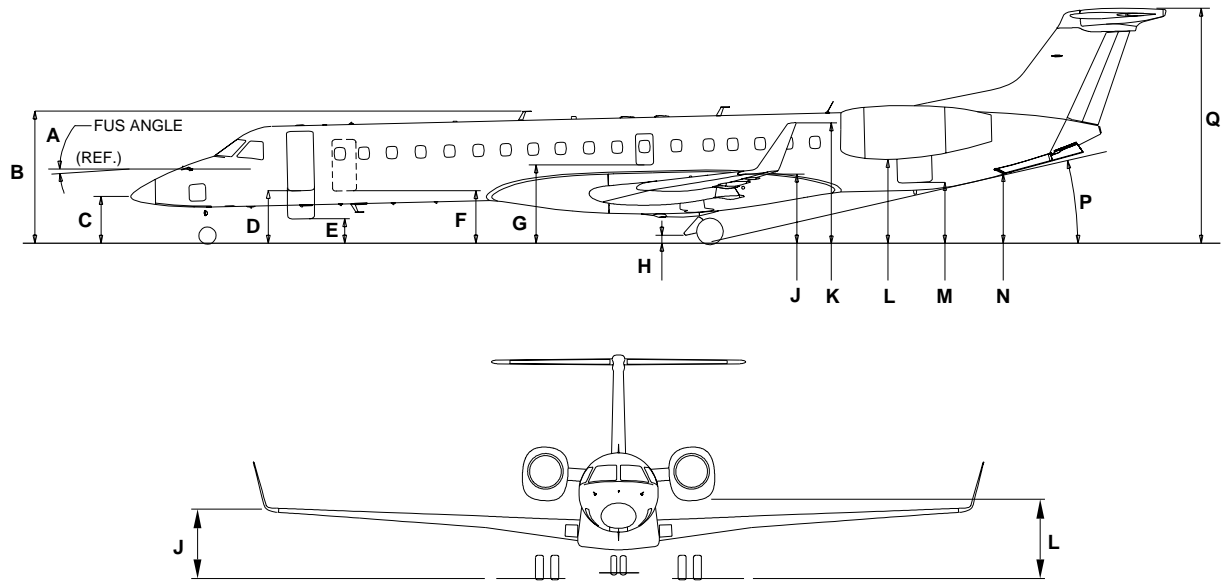
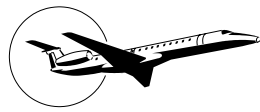


EMB-145MP/MK - GROUND CLEARANCE

WEIGHT	CG (%MAC)	ANTENNA	FUS ANGLE (DEG)	NOSE	MAIN DOOR (A/C FLOOR)	MAIN DOOR (OPEN, 1ST STEP)	EMERGENCY/ SERVICE DOOR	EMERGENCY EXIT	MAIN LDG DOOR	WING TIP	NACELLE	BAGGAGE DOOR	TAILSKID ANGULAR CLEARANCE (DEG)	TAIL BOOM
		A	B	C	D	E	F	G	H	I	J	K	L	M
21090kg 46495lb	17.4	3.748m 12ft 3.6in	-1.27	1.313m 4ft 3.7in	1.480m 4ft 10.3in	0.287m 0ft 11.3in	1.479m 4ft 10.2in	2.202m 7ft 2.7in	0.337m 1ft 1.3in	1.930m 6ft 4.0in	2.345m 7ft 8.3in	1.696m 5ft 6.8in	12.1	6.678m 21ft 10.9in
21090kg 46495lb	43.0	3.765m 12ft 4.2in	-1.00	1.383m 4ft 6.4in	1.527m 5ft 0.1in	0.334m 1ft 1.1in	1.520m 4ft 11.8in	2.202m 7ft 2.7in	0.331m 1ft 1.0in	1.916m 6ft 3.4in	2.312m 7ft 7.0in	1.660m 5ft 5.4in	11.8	6.616m 21ft 8.5in
20990kg 46275lb	17.4	3.748m 12ft 3.6in	-1.27	1.313m 4ft 3.7in	1.480m 4ft 10.3in	0.288m 0ft 11.3in	1.480m 4ft 10.3in	2.203m 7ft 2.7in	0.338m 1ft 1.3in	1.931m 6ft 4.0in	2.346m 7ft 8.4in	1.697m 5ft 6.8in	12.1	6.679m 21ft 11.0in
20990kg 46275lb	43.0	3.766m 12ft 4.3in	-1.00	1.383m 4ft 6.4in	1.527m 5ft 0.1in	0.335m 1ft 1.2in	1.521m 4ft 11.9in	2.203m 7ft 2.7in	0.332m 1ft 1.1in	1.917m 6ft 3.5in	2.313m 7ft 7.1in	1.661m 5ft 5.4in	11.8	6.616m 21ft 8.5in
20090kg 44291lb	16.4	3.753m 12ft 3.8in	-1.29	1314m 4ft 3.7in	1483m 4ft 10.4in	0.291m 0ft 11.5in	1.483m 4ft 10.4in	2.209m 7ft 3.0in	0.345m 1ft 1.6in	1.938m 6ft 4.3in	2.355m 7ft 8.7in	1.706m 5ft 7.2in	12.2	6.691m 21ft 11.4in
20090kg 44291lb	43.0	3.772m 12ft 4.5in	-1.00	1388m 4ft 6.6in	1533m 5ft 0.4in	0.340m 1ft 1.4in	1.526m 5ft 0.1in	2.209m 7ft 3.0in	0.339m 1ft 1.3in	1.923m 6ft 3.7in	2.320m 7ft 7.3in	1.668m 5ft 5.7in	11.8	6.624m 21ft 8.8in
19990kg 44070lb	16.4	3.754m 12ft 3.8in	-1.29	1315m 4ft 3.8in	1484m 4ft 10.4in	0.291m 0ft 11.5in	1.483m 4ft 10.4in	2.210m 7ft 3.0in	0.345m 1ft 1.6in	1.939m 6ft 4.3in	2.356m 7ft 8.8in	1.707m 5ft 7.2in	12.2	6.692m 21ft 11.5in
19990kg 44070lb	43.0	3.772m 12ft 4.5in	-1.00	1389m 4ft 6.7in	1533m 5ft 0.4in	0.341m 1ft 1.4in	1.527m 5ft 0.1in	2.210m 7ft 3.0in	0.339m 1ft 1.3in	1.924m 6ft 3.7in	2.321m 7ft 7.4in	1.669m 5ft 5.7in	11.8	6.625m 21ft 8.8in
19300kg 42549lb	15.6	3.758m 12ft 4.0in	-1.31	1316m 4ft 3.8in	1486m 4ft 10.5in	0.293m 0ft 11.5in	1.486m 4ft 10.5in	2.216m 7ft 3.2in	0.351m 1ft 1.8in	1.945m 6ft 4.6in	2.363m 7ft 9.0in	1.715m 5ft 7.5in	12.3	6.701m 21ft 11.8in
19300kg 42549lb	39.5	3.773m 12ft 4.5in	-1.07	1377m 4ft 6.2in	1527m 5ft 0.1in	0.334m 1ft 1.1in	1.522m 4ft 10.6in	2.214m 7ft 3.4in	0.345m 1ft 2.0in	1.932m 6ft 4.1in	2.333m 7ft 7.9in	1.682m 5ft 6.2in	12.0	6.645m 21ft 9.6in
18700kg 41226lb	15.1	3.762m 12ft 4.1in	-1.32	1317m 4ft 3.9in	1488m 4ft 10.6in	0.296m 0ft 11.7in	1.489m 4ft 10.6in	2.220m 7ft 3.4in	0.356m 1ft 2.0in	1.951m 6ft 4.8in	2.370m 7ft 9.3in	1.731m 5ft 8.1in	12.3	6.709m 22ft 0.1in
18700kg 41226lb	43.0	3.782m 12ft 4.9in	-1.01	1397m 4ft 7.0in	1542m 5ft 0.7in	0.349m 1ft 1.7in	1.536m 5ft 0.5in	2.220m 7ft 3.4in	0.350m 1ft 1.8in	1.935m 6ft 4.2in	2.332m 7ft 7.8in	1.680m 5ft 6.1in	11.9	6.637m 21ft 9.3in
17100kg 37699lb	43.0	3.795m 12ft 5.4in	-1.02	1407m 4ft 7.4in	1554m 5ft 1.2in	0.361m 1ft 2.2in	1.548m 5ft 0.9in	2.234m 7ft 4.0in	0.364m 1ft 2.3in	1.949m 6ft 4.7in	2.348m 7ft 8.4in	1.696m 5ft 6.8in	12.0	6.654m 21ft 10.0in
15500kg 34172lb	12.0	3.787m 12ft 5.1in	-1.41	1324m 4ft 4.1in	1504m 4ft 11.2in	0.311m 1ft 0.2in	1.506m 4ft 11.3in	2.251m 7ft 4.6in	0.389m 1ft 3.3in	1.986m 6ft 6.2in	2.411m 7ft 10.9in	1.764m 5ft 9.4in	12.6	6.761m 22ft 2.2in
13000kg 28660lb	12.0	3.815m 12ft 6.2in	-1.48	1338m 4ft 4.7in	1523m 4ft 12.0in	0.331m 1ft 1.0in	1.527m 5ft 0.1in	2.283m 7ft 5.9in	0.423m 1ft 4.7in	2.022m 6ft 7.6in	2.452m 7ft 0.5in	1.807m 5ft 11.1in	12.9	6.810m 22ft 4.1in
13000kg 28660lb	43.0	3.842m 12ft 7.3in	-1.05	1349m 4ft 9.0in	1598m 5ft 2.9in	0.405m 1ft 3.9in	1.592m 5ft 2.7in	2.283m 7ft 5.9in	0.413m 1ft 4.3in	2.000m 6ft 6.7in	2.400m 7ft 10.5in	1.748m 5ft 8.8in	12.4	6.709m 22ft 0.1in
12000kg 26455lb	40.0	3.852m 12ft 7.7in	-1.14	1442m 4ft 8.8in	1598m 5ft 2.9in	0.406m 1ft 4.0in	1.595m 5ft 2.8in	2.298m 7ft 6.5in	0.430m 1ft 4.9in	2.019m 6ft 7.5in	2.425m 7ft 11.5in	1.775m 5ft 9.9in	12.6	6.744m 22ft 1.5in

APM020253.MCE A

*Figure 2.3.1 - Ground Clearances
Sheet 3*



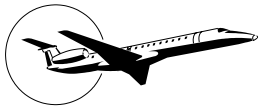
EMB-145XR - GROUND CLEARANCE

WEIGHT	CG (%MAC)	FUS ANGLE (DEG.)	ANTENNA	NOSE	MAIN DOOR	MAIN DOOR (OPEN, 1ST STEP)	EMERG./ SERVICE DOOR	EMERG. EXIT	MAIN LDG DOOR	WING TIP	WINGLET TIP	NACELLE	BAGGAGE DOOR	TAIL BUMPER	TAILSKID ANGLE	TAIL BOOM
		A	B	C	D	E	F	G	H	J	K	L	M	N	P	Q
24200kg 53352lb	20.4%	-1.30	3.7372m 12ft 3.1in	1.2890m 4ft 2.8in	1.4591m 4ft 9.4in	0.2666m 10.5in	1.4593m 4ft 9.5in	2.1832m 7ft 2in	0.3235m 1ft .74in	2.0098m 6ft 7.1in	3.3968m 11ft 1.7in	2.3333m 7ft 7.9in	1.6870m 5ft 6.4in	1.6360m 5ft 4.4in	12.10	6.6729m 21ft 10.7in
24200kg 53352lb	38.0%	-1.14	3.7467m 12ft 3.5in	1.3318m 4ft 4.4in	1.4877m 4ft 10.6in	0.2952m 11.6in	1.4842m 4ft 10.4in	2.1832m 7ft 2in	0.3199m 1ft .60in	1.9988m 6ft 6.7in	3.3844m 11ft 1.2in	2.3135m 7ft 7.0in	1.6647m 5ft 5.5in	1.6090m 5ft 3.4in	11.90	6.6343m 21ft 9.2in
24100kg 53131lb	20.4%	-1.30	3.7377m 12ft 3.2in	1.2893m 4ft 2.8in	1.4595m 4ft 9.5in	0.2670m 10.5in	1.4597m 4ft 9.5in	2.1837m 7ft 2in	0.3241m 1ft .76in	2.0104m 6ft 7.1in	3.3975m 11ft 1.8in	2.3340m 7ft 7.9in	1.6877m 5ft 6.4in	1.6370m 5ft 4.5in	12.11	6.737m 21ft 10.7in
24100kg 53131lb	38.0%	-1.14	3.7472m 12ft 3.5in	1.3322m 4ft 4.5in	1.4882m 4ft 10.6in	0.2956m 11.6in	1.4847m 4ft 10.5in	2.1837m 7ft 2in	0.3205m 1ft .62in	1.9994m 6ft 6.7in	3.3849m 11ft 1.3in	2.3141m 7ft 7.1in	1.6654m 5ft 5.6in	1.6100m 5ft 3.4in	11.90	6.6350m 21ft 9.2in
20000kg 44092lb	16.4%	-1.38	3.7592m 12ft 4.0in	1.2950m 4ft 3.0in	1.4719m 4ft 10.0in	0.2795m 11.0in	1.4739m 4ft 10in	2.2097m 7ft 3in	0.3517m 1ft 1.9in	2.0415m 6ft 8.4in	3.4293m 11ft 3.0in	2.3693m 7ft 9.3in	1.7242m 5ft 7.9in	1.6760m 5ft 6in	12.39	6.7178m 22ft 0.5in
20000kg 44092lb	39.3%	-1.15	3.7724m 12ft 4.5in	1.3550m 4ft 5.4in	1.5120m 4ft 11.5in	0.3195m 1ft 0.6in	1.5088m 4ft 11.4in	2.2096m 7ft 3in	0.3466m 1ft 1.7in	2.0260m 6ft 7.8in	3.4116m 11ft 2.3in	2.3413m 7ft 8.2in	1.6927m 5ft 6.6in	1.6370m 5ft 4.5in	12.10	6.6635m 21ft 10.3in
19300kg 42549lb	39.5%	-1.15	3.7775m 12ft 4.7in	1.3597m 4ft 5.5in	1.5169m 4ft 11.7in	0.3243m 1ft 0.8in	1.5137m 4ft 11.6in	2.2148m 7ft 3.2in	0.3518m 1ft 1.9in	2.0314m 6ft 8.0in	3.4170m 11ft 2.5in	2.3468m 7ft 8.4in	1.6983m 5ft 6.9in	1.6430m 5ft 4.7in	12.14	6.6692m 21ft 10.6in
17100kg 37699lb	43.0%	-1.10	3.7998m 12ft 5.6in	1.3922m 4ft 6.8in	1.5450m 5ft 8in	0.3525m 1ft 1.9in	1.5407m 5ft 0.7in	2.2342m 7ft 4in	0.3702m 1ft 2.6in	2.0475m 6ft 8.6in	3.4327m 11ft 3.2in	2.3602m 7ft 8.9in	1.7109m 5ft 7.4in	1.6540m 5ft 5.1in	12.22	6.6769m 21ft 10.9in
15500kg 34172lb	12.0%	-1.50	3.7929m 12ft 5.3in	1.3057m 4ft 3.7in	1.4925m 4ft 10.8in	0.3001m 11.8in	1.4970m 4ft 10.9in	2.2501m 7ft 4.6in	0.3946m 1ft 3.5in	2.0895m 6ft 10.3in	3.4784m 11ft 4.9in	2.4235m 7ft 11.4in	1.7801m 5ft 10in	1.7350m 5ft 8.3in	12.81	6.7850m 22ft 3.1in
13800kg 30424lb	12.0%	-1.54	3.8111m 12ft 6.0in	1.3148m 4ft 3.8in	1.5054m 4ft 11.3in	0.3130m 1ft 3in	1.5109m 4ft 11.5in	2.2709m 7ft 5.4in	0.4164m 1ft 4.4in	2.1133m 6ft 11.2in	3.5026m 11ft 5.9in	2.4498m 8ft 0.5in	1.8071m 5ft 11in	1.7640m 5ft 9.4in	13.01	6.8165m 24ft 4.4in
13800kg 30424lb	43.0%	-1.11	3.8361m 12ft 7.0in	1.4257m 4ft 8.1in	1.5798m 5ft 2.2in	0.3872m 1ft 3.2in	1.5758m 5ft 2.0in	2.2713m 7ft 5.4in	0.4076m 1ft 4.0in	2.0855m 6ft 10.1in	3.4708m 11ft 4.7in	2.3989m 7ft 10.4in	1.7498m 5ft 8.9in	1.6930m 5ft 6.7in	12.49	6.7171m 22ft 0.5in
12800kg 28219lb	30.5%	-1.37	3.8337m 12ft 6.9in	1.3718m 4ft 6.0in	1.5478m 5ft 0.9in	0.3553m 1ft 2.0in	1.5495m 5ft 1.0in	2.2836m 7ft 5.9in	0.4255m 1ft 4.8in	2.1148m 6ft 11.3in	3.5025m 11ft 5.9in	2.4420m 8ft 0.14in	1.7967m 5ft 10.7in	1.7480m 5ft 8.8in	12.89	6.7893m 22ft 3.3in

EMB-145XR

145APM020273.MCE

*Figure 2.3.1 - Ground Clearances
Sheet 4*



2.4 Interior Arrangements

2.4.1 Standard Interior Arrangement

The standard interior arrangement provides accommodation for two pilots, one flight observer, one flight attendant, and 50 passengers. One additional flight attendant seat is available as an option.

2.4.2 Cockpit

The "quiet and dark" cockpit is designed to accommodate the pilots with comfort during all flight phases, with minimum workload and maximum safety. The cockpit is provided with two pilot seats, a foldable flight observer seat, control columns and pedals, control pedestal, left, right, and aft consoles, as well as main, overhead, circuit breaker, and glareshield panel. A sun shade is provided for each pilot and the compartment is separated from the passenger cabin by a partition with a lockable door.

2.4.3 Panels

The main instrument panel displays the main navigation, engine, and systems indications, through the PFD, MFD, and EICAS displays, ELT reset, the audio selection, and the landing gear and pedal electric adjustment controls. It also accommodates the standby instruments and displays reversionary functions. One of the different possible configurations of the main instrument panel includes radio management units.

A glareshield panel is located over the main panel, including the master caution and master warning lights, flight control, display control, and lighting intensity controls. One of the different possible configurations of the glareshield panel includes dual radar control panels.

An overhead panel provides the hydraulic, electrical, powerplant, APU, fire protection, environmental, and external and internal lighting controls. The circuit breakers, in ordered and grouped positions, are placed in a panel aft of the overhead panel.

2.4.4 Left and Right Consoles

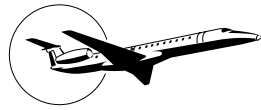
The left and right consoles accommodate the nose wheel steering handle, ashtrays, holders for cups, headset, and microphone, oxygen masks and oxygen control, a waste container, rechargeable flashlight, and recesses for crew publications.

2.4.5 Control Pedestal

The control pedestal, located between the two pilots, presents the engine control levers, the engine thrust rating panel, the speed brake lever, the emergency/parking brake lever, flight control switches (including flap selection), the pressurization control, the EICAS reversionary panel, radar control panel, HF control (optional), aileron/elevator disconnect handles, Autopilot control, SPS, T/O configuration switch, and an FMS control display unit. One of different possible configurations of the control pedestal includes radio management units.

2.4.6 Pilot Seat

The pilot seat is provided with longitudinal, vertical (electrically actuated), seat back, and lumbar adjustments. The seat is attached to tracks which permit the horizontal adjustments.



An extended longitudinal travel permits pilot rest during long cruise flights (pilot foot rests are provided at the bottom of the main instrument panel).

2.4.7 Passenger Cabin

A 0.43 m (17 in) wide aisle, with a recessed floor leaving a 1.82 m (6 ft) height, allows for stand-up walking and the use of standard catering trolleys. The passenger cabin is 2.10 m (6 ft 11 in) wide and the standard configuration accommodates 50 passengers in 16 double seats on the right side, and 18 single seats on the left side, with a 31 in pitch. Different cabin layouts with increased capacity for galley and wardrobe are available as optional models.

2.4.8 Passenger Seat

The ergonomic reclining seats were designed for a 0.79 m (31 in) pitch, with comfortable leg room. Double seats incorporate fold-up center arm rests. All seats are offered with snack tables, magazine pouches, underseat life-vest stowage, seat belts, and an adequate underseat room for carry-on articles.

2.4.9 Passenger Service Unit

The passenger service unit contains gasper air outlets, reading lights, loudspeakers, attendant calling buttons, warnings, and oxygen dispensing unit for each seat.

2.4.10 Overhead Bin

The overhead bin is divided into eleven sections and is installed on the right side of the cabin. The bins have a total volume of 1.90 m³ (67.1 ft³) and is designed for a 290 kg (639 lb) loading.

2.4.11 Wardrobe

A wardrobe with a 0.93 m³ (32.9 ft³) and 70 kg (154 lb) capacity is offered for carry-on articles on the forward right side of the passenger cabin between the galley and cockpit partition.

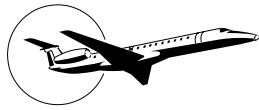
2.4.12 Stowage Compartment

A stowage compartment with a 0.45 m³ (16 ft³) and 40 kg (88 lb) capacity is also offered on the forward right side of the passenger cabin, close to the service door. Such compartment is modular so that it can be replaced by one or two half trolleys, as in the optional models.

2.4.13 Flight Attendant Station

The standard flight attendant station is positioned at the cockpit partition, close to the main door. The seat is of the fold-away type, to avoid interference with the door passageway. A seat for a second flight attendant is available, as an option, at the aft end of the aisle, standing in front of the lavatory door. When not in use, adequate mechanisms allow its sliding against the lavatory wall, behind the last double-seat row.

The attendant seats are made up of machined parts combined with flat sandwich panels of graphite and Nomex honeycomb core.



2.4.14 Lavatory

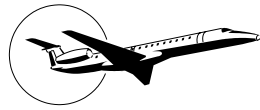
The lavatory is installed at the aft cabin and contains a washbasin, waste container, ashtray, mirror, paper dispenser, automatic fire extinguisher, smoke detection system, and a recirculating toilet unit. A toilet shroud and a ventilation system, at the cabinet and waste tank, assure an odorless environment.

2.4.15 Galley

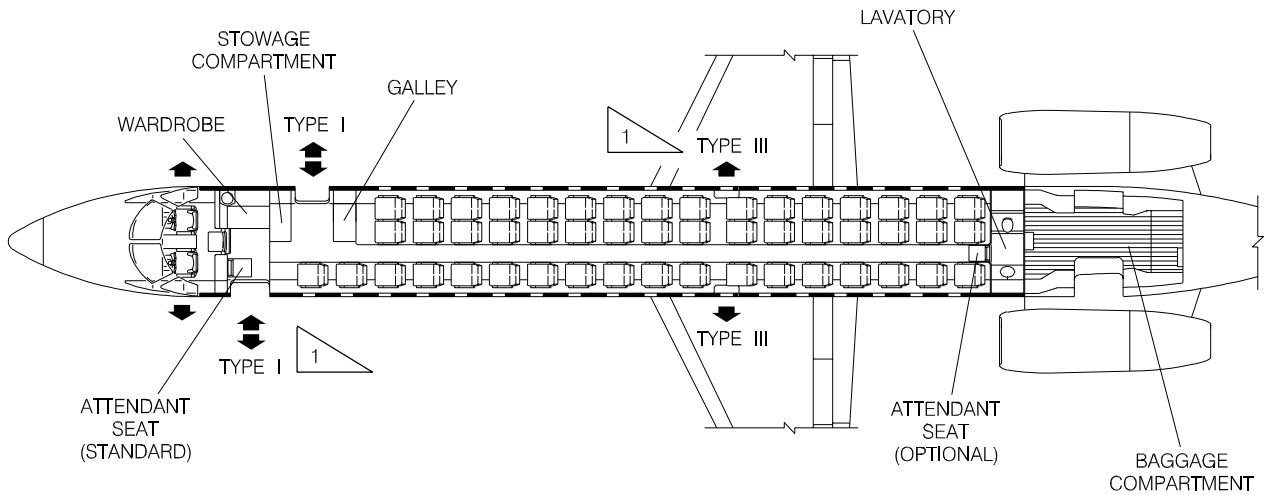
The galley is installed in the forward passenger cabin.

2.4.16 Baggage Compartment

The baggage compartment complies with the FAR-25 "class D" requirements (standard) or FAR-25 "class C" (optional), presenting an available volume of 9.21 m³ (325 ft³) and maximum loading of 1200 kg (2645 lb). The floor is designed for 390 kg/m² (80 lb/ft²) uniform distributed loading, and is provided with anchor plates for high-density load tie-down.



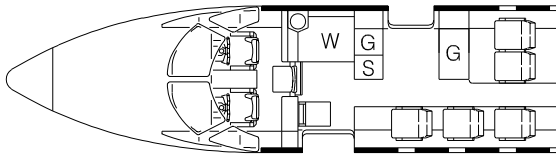
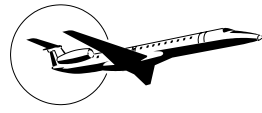
CARGO/BAGGAGE VOLUME-ft ³ (m ³)	
WARDROBE	32.9 (0.93)
STOWAGE COMPARTMENT	16 (0.45)
GALLEY	34.8 (0.99)
BAGGAGE COMPARTMENT	325 (9.2)
OVERHEAD BIN	67.1 (1.9)
UNDERSEAT VOLUME	79.8 (2.3)



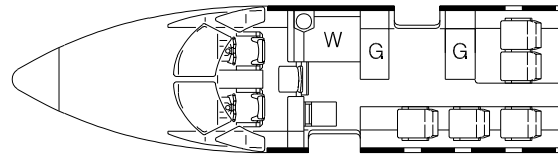
 TYPE I AND TYPE III ACCORDING TO FAR 25-PAR.25-807

APM020010.MCE A

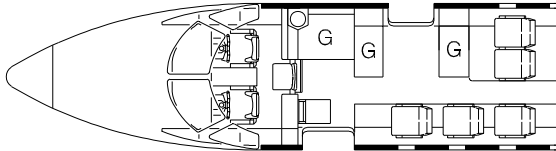
Figure 2.4.1 - EMB-145 Interior Arrangements-Basic Configuration



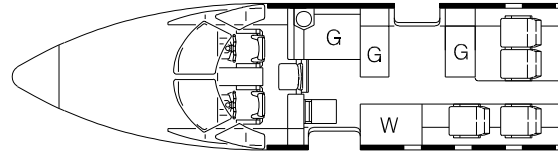
OPTION 1



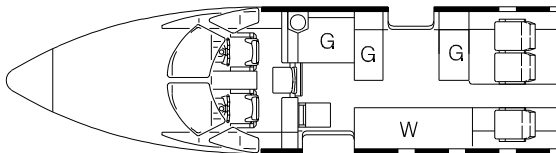
OPTION 2



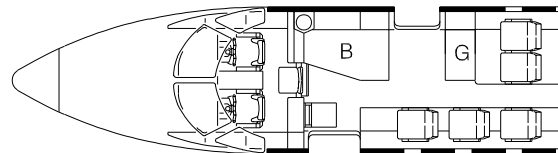
OPTION 3



OPTION 4



OPTION 5



OPTION 6

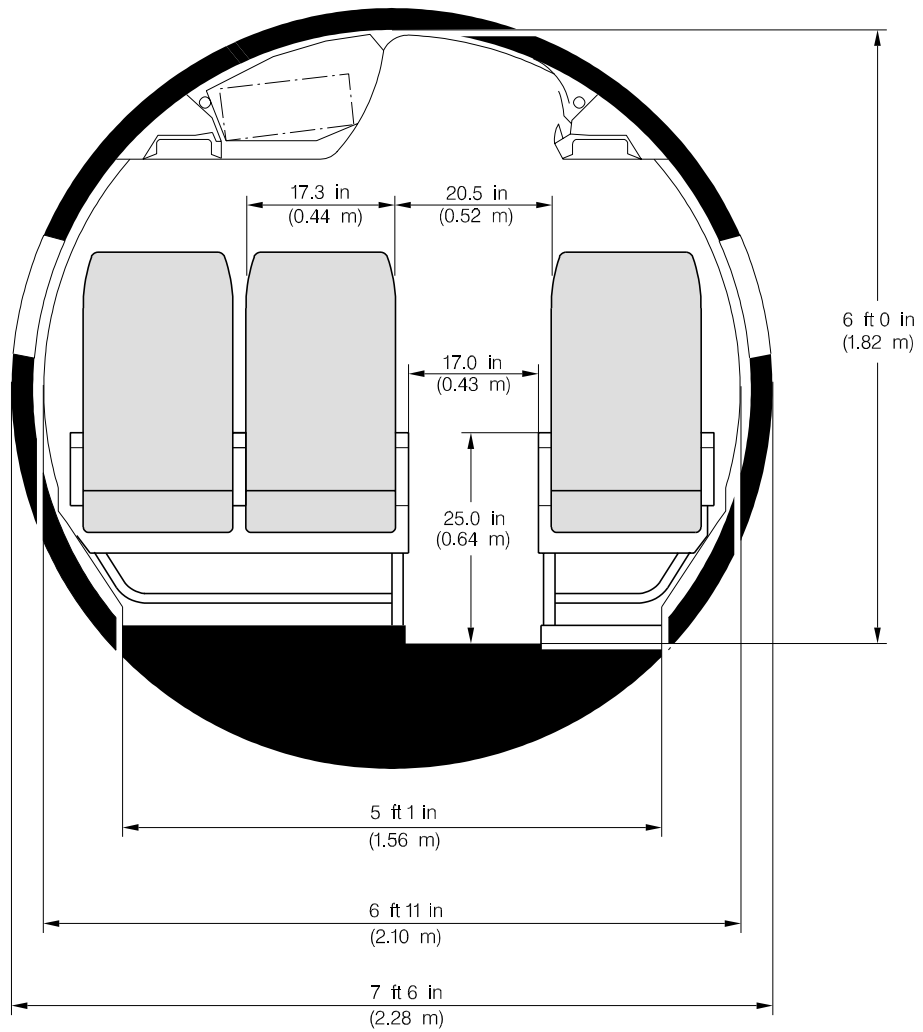
ITEMS	OPTION 1	OPTION 2	OPTION 3	OPTION 4	OPTION 5	OPTION 6A
PASSENGERS	50	50	50	49	48	50
HALF TROLLEY	3	4	6	6	6	-
2/3 HALF TROLLEY	-	-	-	-	-	6
GALLEY VOLUME (G) m ³ (cu.ft)	1.27 (44.7)	1.49 (52.7)	2.42 (85.4)	2.42 (85.4)	2.42 (85.4)	2.42 (85.4)
STOWAGE VOLUME (S) m ³ (cu.ft)	0.17 (6.0)	-	-	-	-	0.69 (24.6)
CATERING lb (kg)	217 (477)	257 (565)	320 (705)	320 (705)	320 (705)	153 (235)
WARDROBE VOLUME (W) m ³ (cu.ft)	0.93 (32.9)	0.93 (32.9)	-	0.57 (20.2)	1.07 (37.6)	1.12 (39.6)
EMERGENCY EQUIPMENT STOWAGE UNIT m ³ (cu.ft)	0.11 (3.9)	0.11 (3.9)	0.11 (3.9)	-	-	0.11 (3.9)

APM020011.MCE B

Figure 2.4.2 - EMB-145 Interior Arrangements-Optional Configuration



2.5 Passenger Cabin Cross-Section

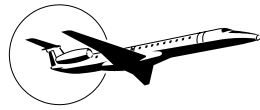


APM020012.MCE A

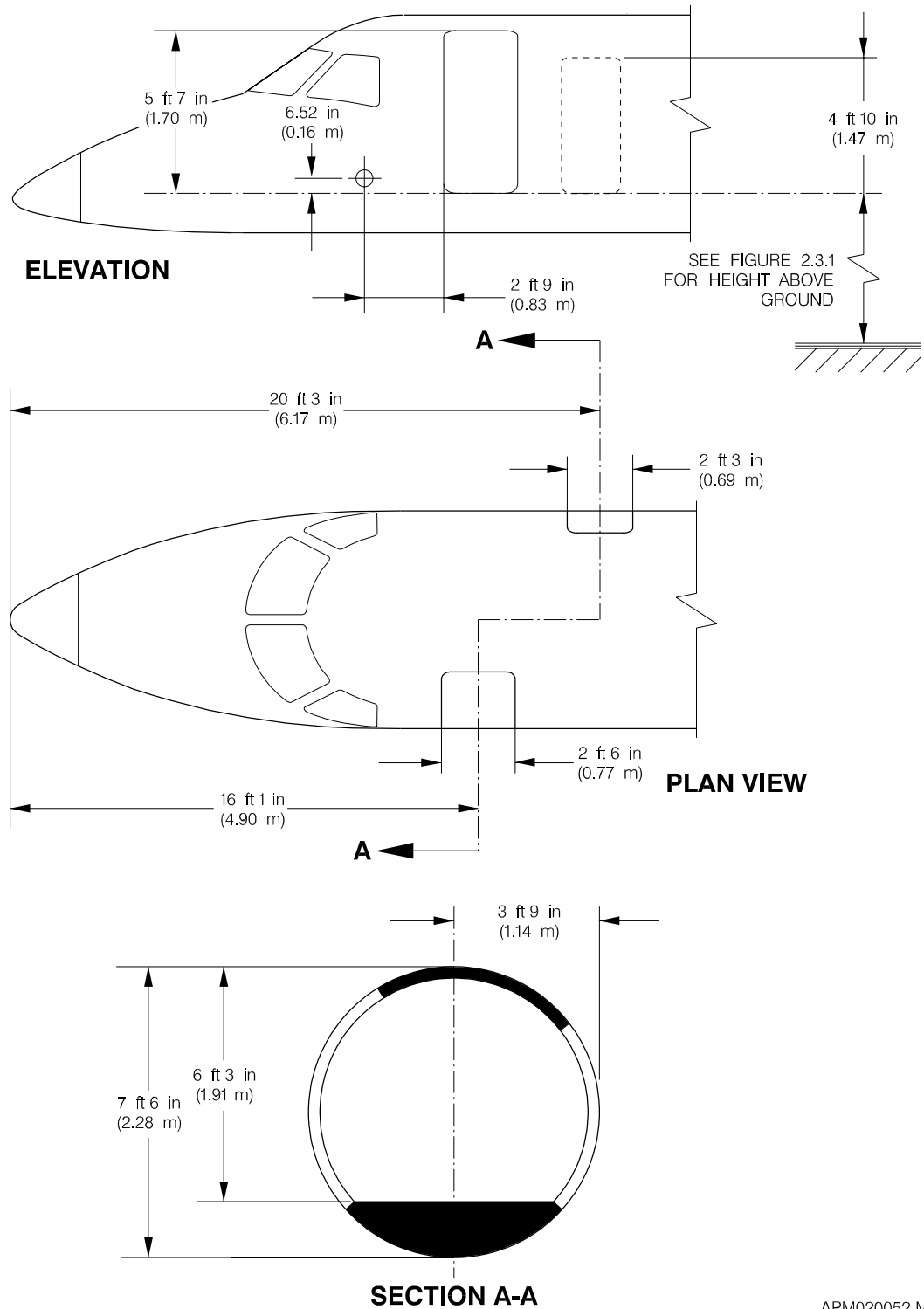
Figure 2.5.1 - EMB-145 Passenger Cabin Cross-Section

2.6 Lower Compartment Containers

The EMB-145 aircraft does not have lower compartment containers.

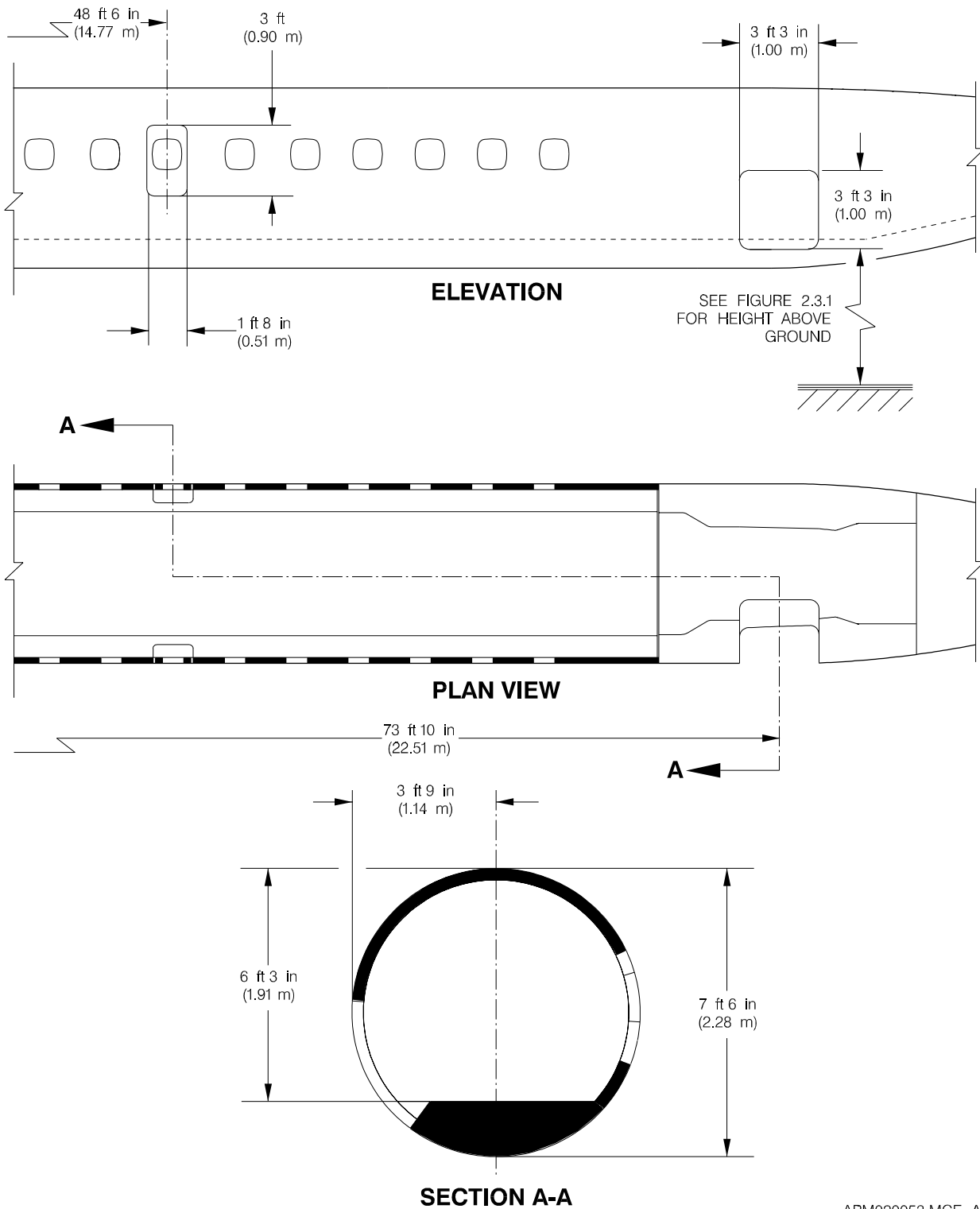


2.7 Door Clearances



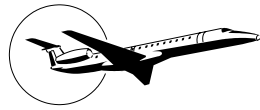
APM020052.MCE B

*Figure 2.7.1 - EMB-145 Door Clearances
Sheet 1*



APM020053.MCE A

*Figure 2.7.1 - EMB-145 Door Clearances
Sheet 2*



3. AIRPLANE PERFORMANCE

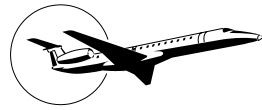
3.1 General Information

Section 3.2 presents payload x range information for a specific long range, cruise altitude, and the fuel reserve condition shown.

Sections 3.3 and 3.4 represent FAR takeoff and landing runway length requirements for FAA certification. Standard day temperatures for the altitudes shown are tabulated below:

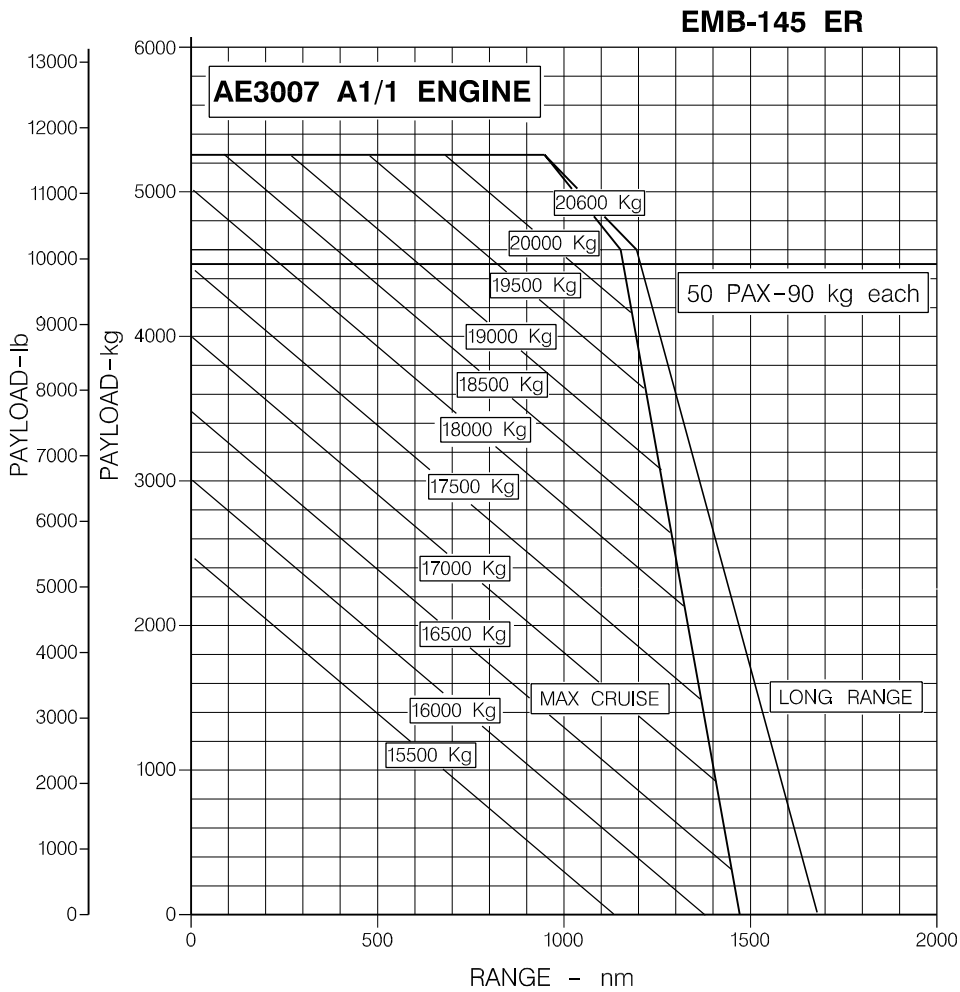
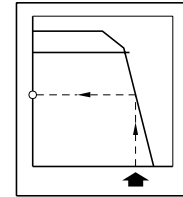
Table 3.1.1 - Standard Day Temperatures x Elevation

ELEVATION		STANDARD DAY TEMP	
ft	m	°F	°C
0	0	59	15
2000	610	51.9	11.6
4000	1220	44.7	7.1
6000	1830	37.6	3.1
8000	2440	30.5	-0.8



3.2 Payload x Range

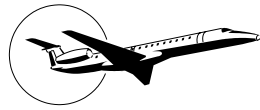
PAYLOAD X RANGE
ISA



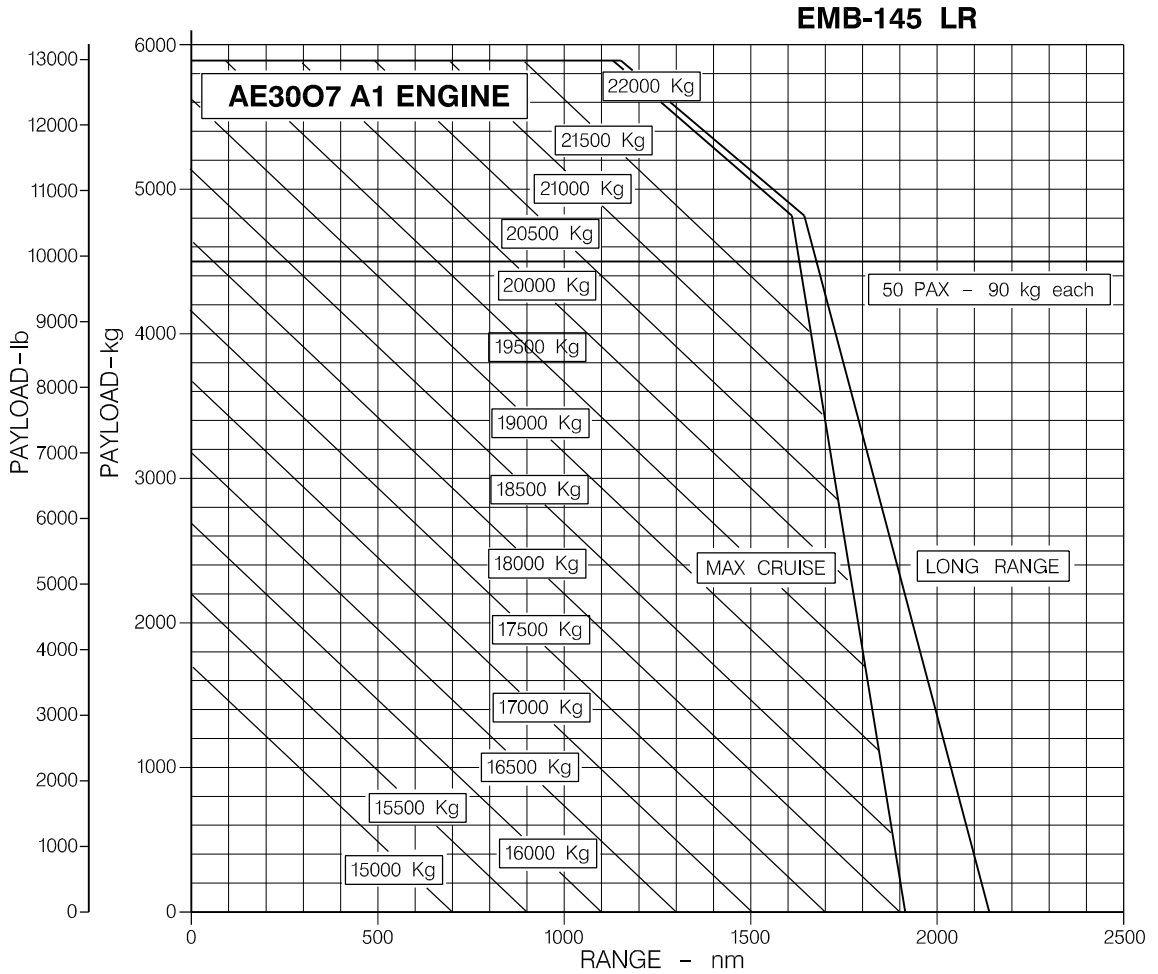
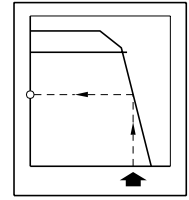
NOTES: FLIGHT LEVEL.....370
RESERVE.....100nm ALTERNATE + 45min HOLDING
MAX TAKEOFF WEIGHT.....20600 kg
MAX ZERO FUEL WEIGHT.....17100 kg
BASIC OPERATING WEIGHT.....11843 kg
MAX USABLE FUEL.....4173 kg

APM030118.MCE B

*Figure 3.2.1 - Payload x Range for Long Range Cruise at 37,000 ft, Engine with Thrust Reverser
Sheet 1*



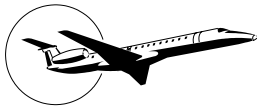
PAYLOAD X RANGE
ISA



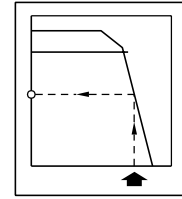
NOTES: FLIGHT LEVEL.....370
 RESERVE.....100 nm ALTERNATE + 45 min HOLDING
 MAX TAKEOFF WEIGHT.....21990 kg (48480 lb)
 MAX ZERO FUEL WEIGHT.....17900 kg (39463 lb)
 BASIC OPERATING WEIGHT.....12010 kg (26477 lb)
 MAX USABLE FUEL.....5187 kg (11435 lb)

APM030117.MCE B

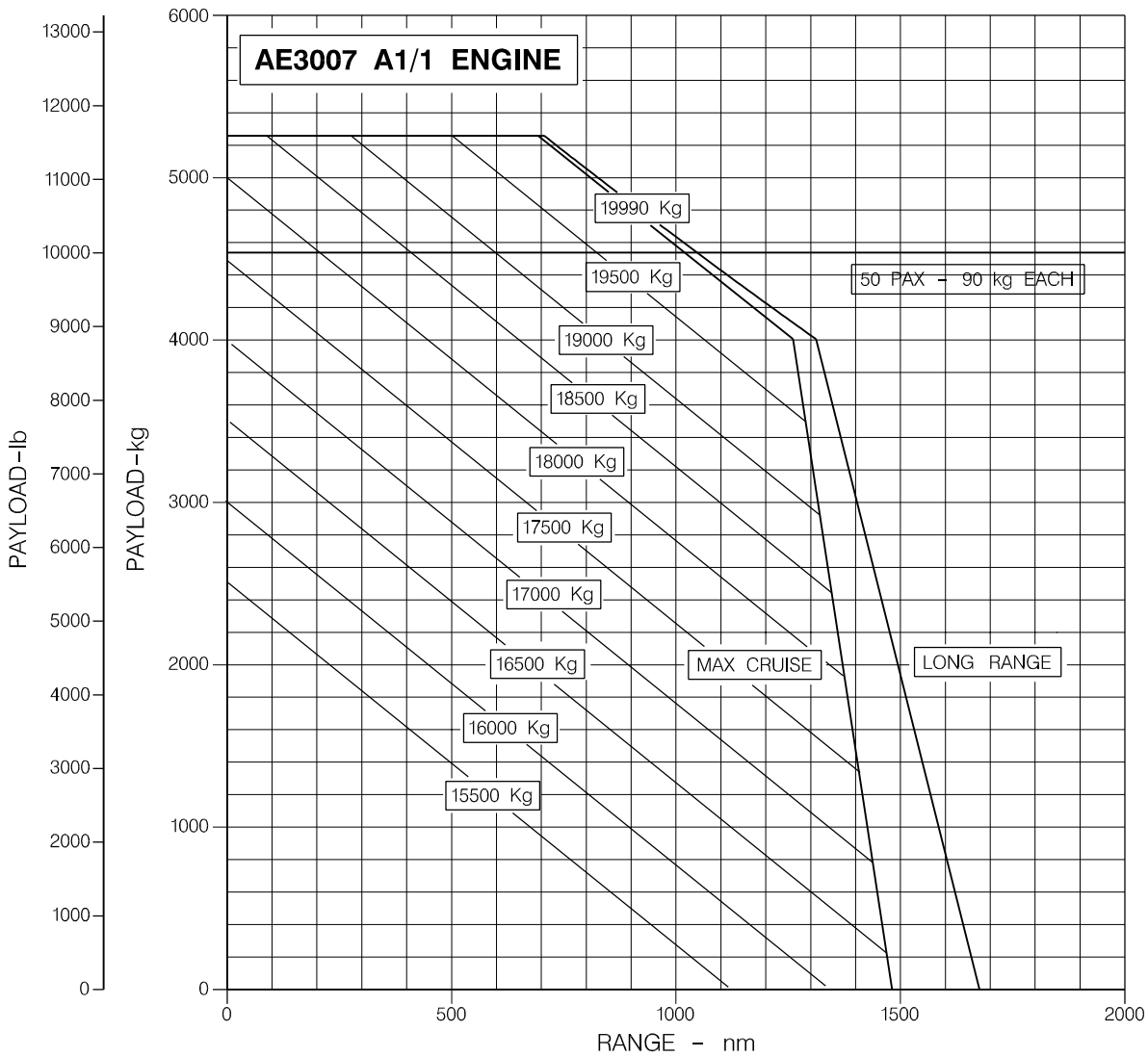
*Figure 3.2.1 - Payload x Range for Long Range Cruise at 37,000 ft, Engine with Thrust Reverser
Sheet 2*



PAYLOAD X RANGE
ISA



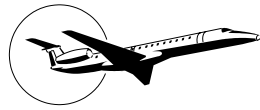
EMB-145 EU



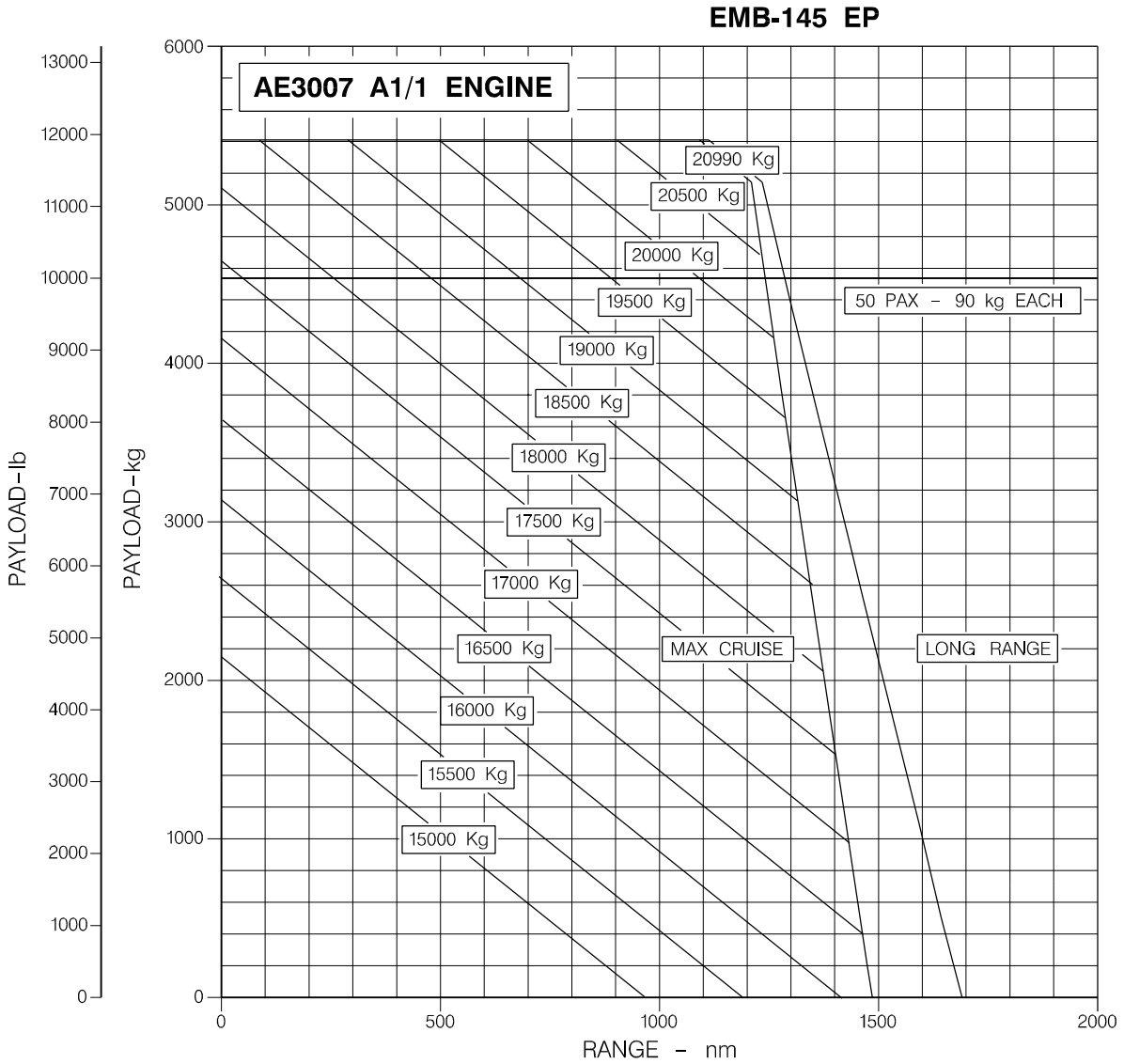
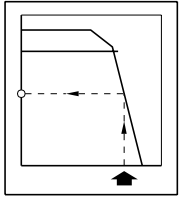
NOTES: FLIGHT LEVEL.....370
 RESERVE.....100 nm ALTERNATE + 45 min HOLDING
 MAX TAKEOFF WEIGHT.....19990 kg (44070 lb)
 MAX ZERO FUEL WEIGHT.....17100 kg (37699 lb)
 BASIC OPERATING WEIGHT.....11843 kg (26109 lb)
 MAX USABLE FUEL.....4173 kg (9200 lb)

APM030119.MCE B

*Figure 3.2.1 - Payload x Range for Long Range Cruise at 37,000 ft, Engine with Thrust Reverser
Sheet 3*



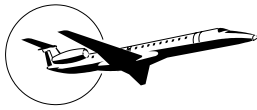
PAYLOAD VS RANGE
ISA



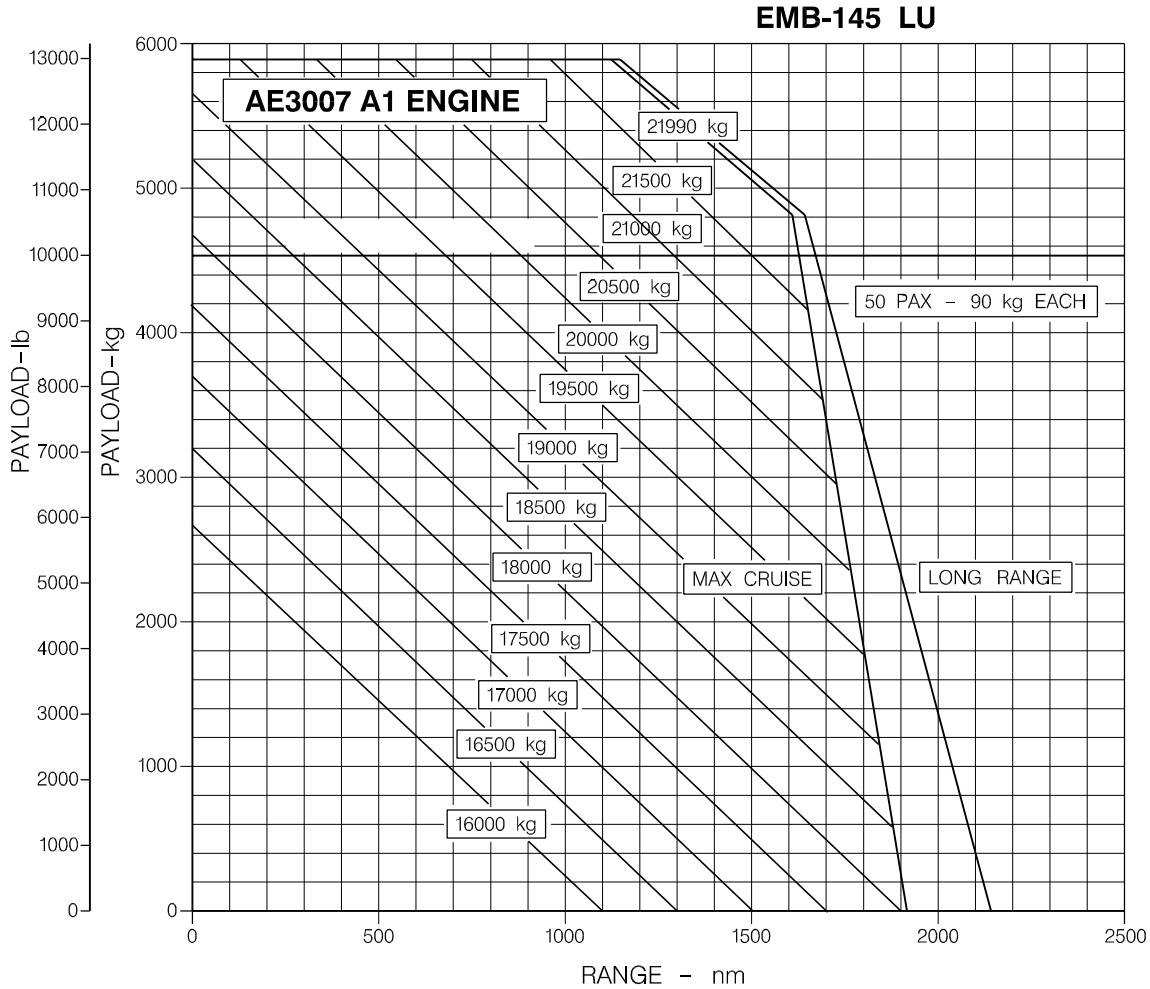
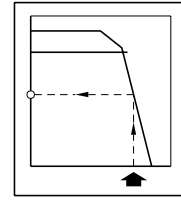
NOTES: FLIGHT LEVEL.....370
 RESERVE.....100 nm ALTERNATE + 45 min HOLDING
 MAX TAKEOFF WEIGHT.....20990 kg (46275 lb)
 MAX ZERO FUEL WEIGHT.....17100 kg (37699 lb)
 BASIC OPERATING WEIGHT.....11690 kg (25772 lb)
 MAX USABLE FUEL.....4173 kg (9199 lb)

APM030120.MCE B

Figure 3.2.1 - Payload x Range for Long Range Cruise at 37,000 ft, Engine with Thrust Reverser
Sheet 4



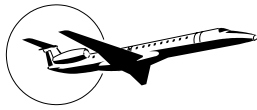
PAYLOAD X RANGE
ISA



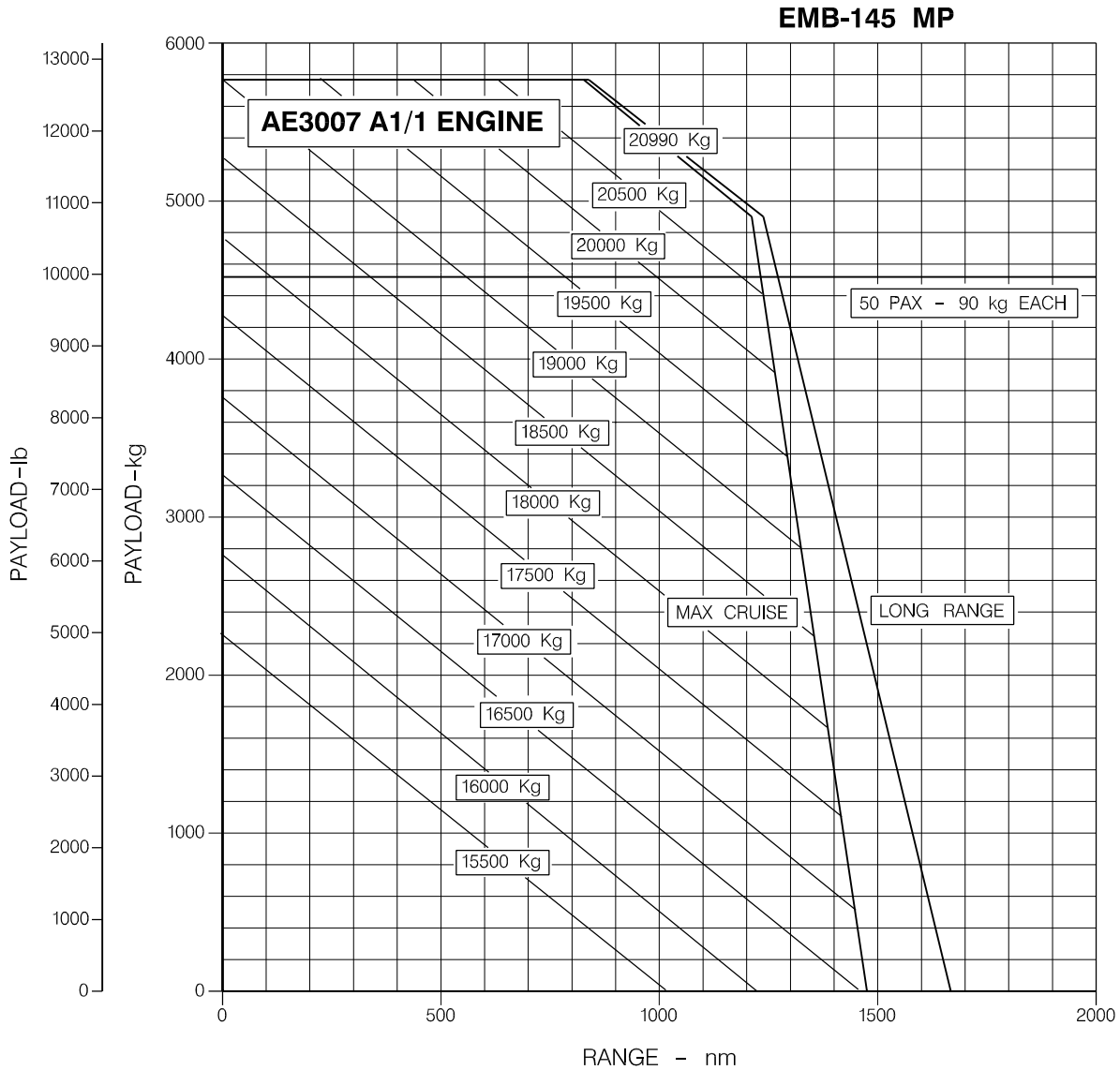
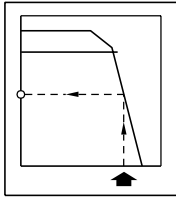
NOTES: FLIGHT LEVEL.....370
 RESERVE.....100 nm ALTERNATE + 45 min HOLDING
 MAX TAKEOFF WEIGHT.....21990 kg (48480 lb)
 MAX ZERO FUEL WEIGHT.....17900 kg (39463 lb)
 BASIC OPERATING WEIGHT.....12010 kg (26478 lb)
 MAX USABLE FUEL.....5187 kg (11435 lb)

APM030352.MCE A

*Figure 3.2.1 - Payload x Range for Long Range Cruise at 37,000 ft, Engine with Thrust Reverser
Sheet 5*



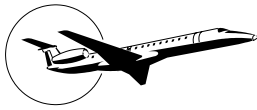
PAYLOAD X RANGE
ISA



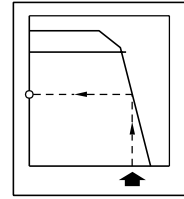
NOTES: FLIGHT LEVEL.....370
 RESERVE.....100 nm ALTERNATE + 45 min HOLDING
 MAX TAKEOFF WEIGHT.....20990kg (46275 lb)
 MAX ZERO FUEL WEIGHT.....17900 kg (39022 lb)
 BASIC OPERATING WEIGHT.....11934 kg (26310 lb)
 MAX USABLE FUEL.....4173 kg (9200 lb)

APM030351.MCE A

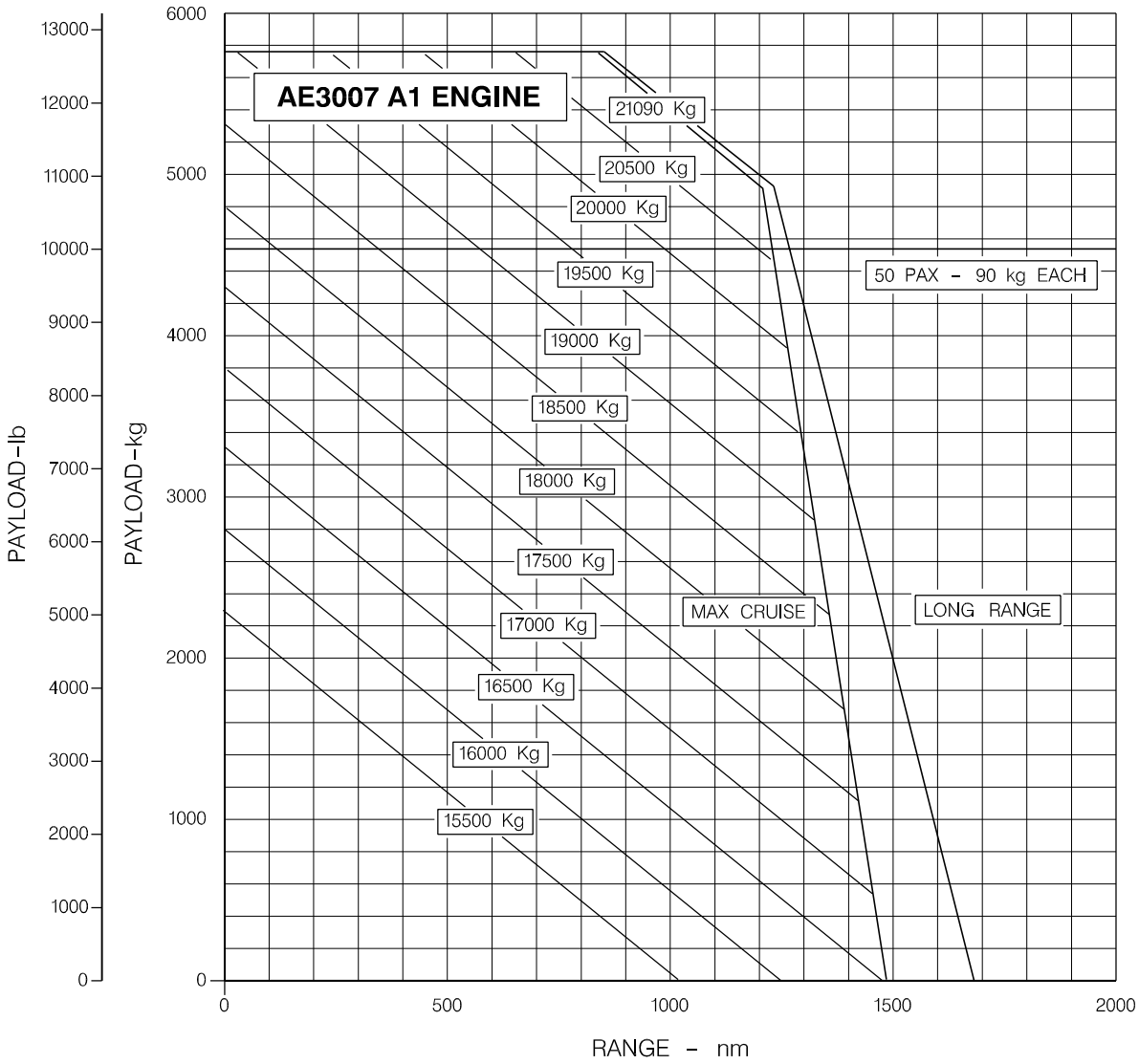
*Figure 3.2.1 - Payload x Range for Long Range Cruise at 37,000 ft, Engine with Thrust Reverser
Sheet 6*



PAYLOAD X RANGE
ISA



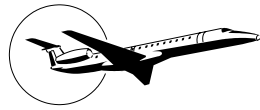
EMB-145 MP



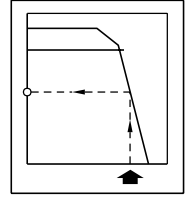
NOTES : MAX TAKEOFF WEIGHT.....20990kg (46275 lb)
 MAX ZERO FUEL WEIGHT.....17900 kg (39022 lb)
 BASIC OPERATING WEIGHT.....11934 kg (26310 lb)
 MAX USABLE FUEL.....4173 kg (9200 lb)

APM030354.MCE

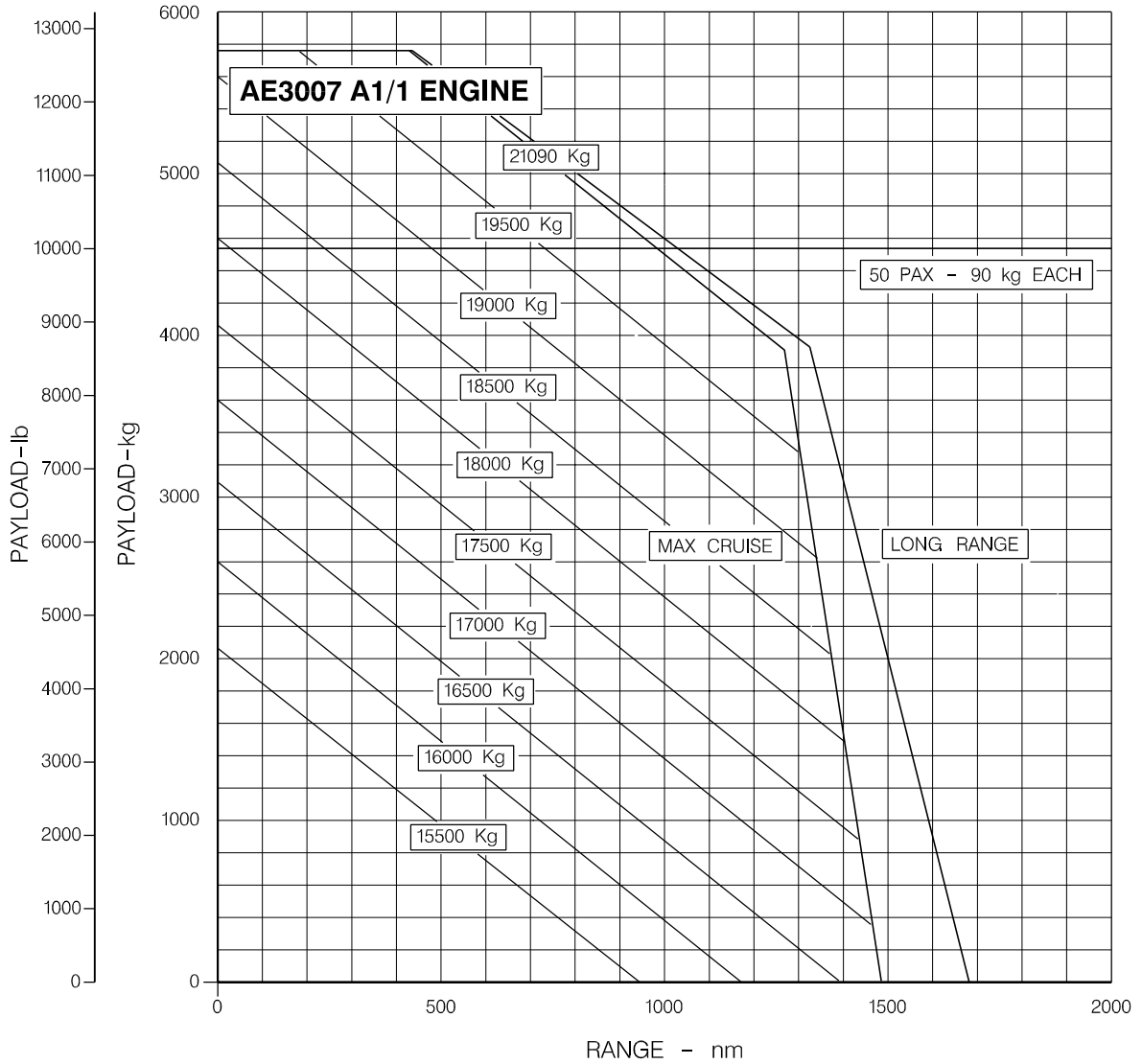
*Figure 3.2.1 - Payload x Range for Long Range Cruise at 37,000 ft, Engine with Thrust Reverser
Sheet 7*



PAYLOAD X RANGE
ISA



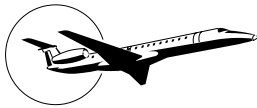
EMB-145 MK



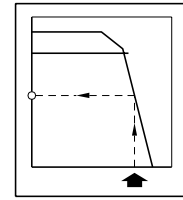
NOTES : MAX TAKEOFF WEIGHT.....19990kg (46275 lb)
 MAX ZERO FUEL WEIGHT.....17700 kg (39022 lb)
 BASIC OPERATING WEIGHT.....11934 kg (26310 lb-std.config)
 MAX USABLE FUEL.....4173 kg (9200 lb)

APM030355.MCE

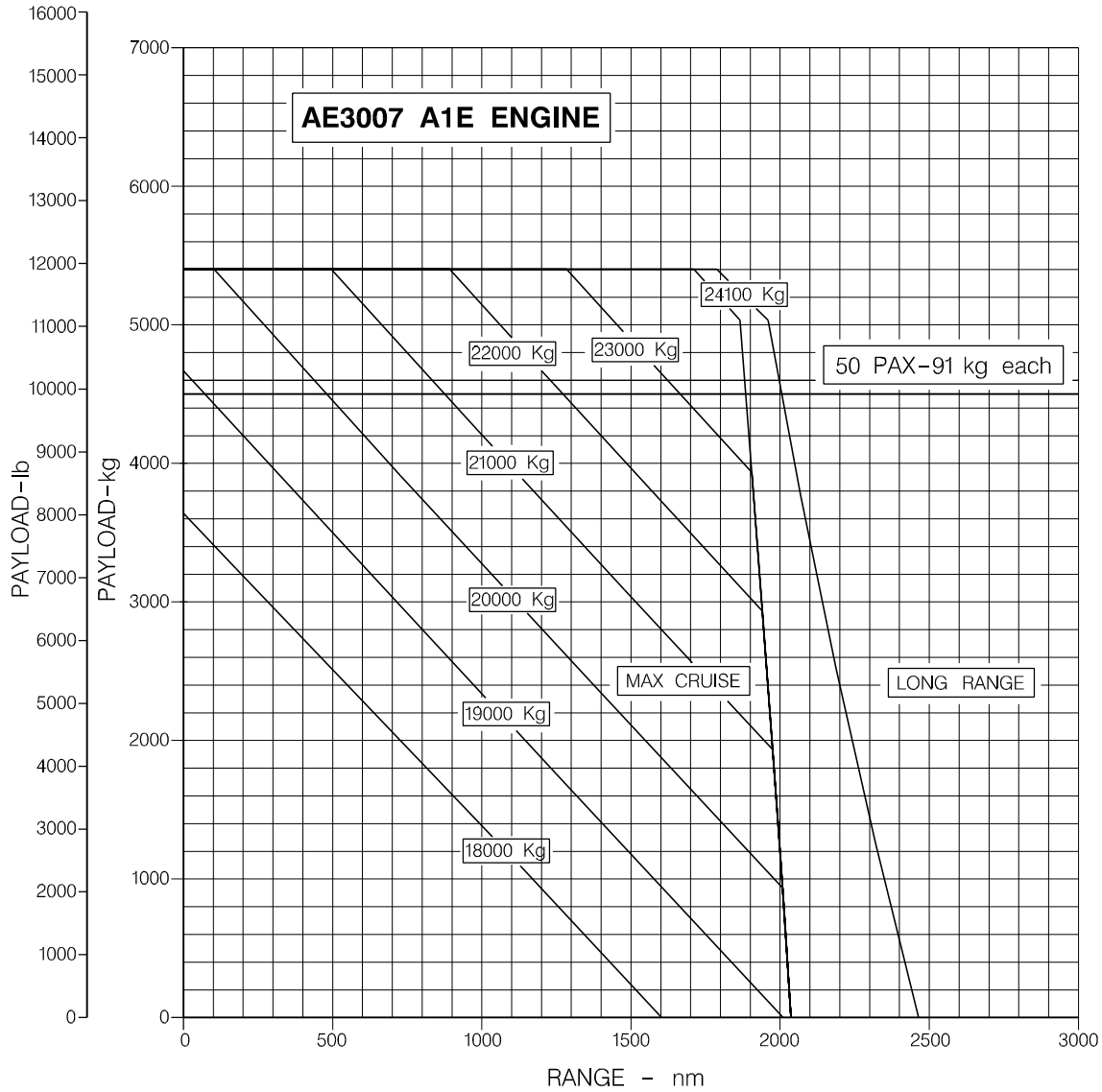
*Figure 3.2.1 - Payload x Range for Long Range Cruise at 37,000 ft, Engine with Thrust Reverser
Sheet 8*



PAYLOAD X RANGE
ISA



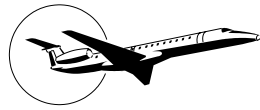
EMB-145 XR



NOTES: FLIGHT LEVEL.....370
RESERVE.....100nm ALTERNATE + 45min HOLDING
MAX TAKEOFF WEIGHT.....24100 kg (53132 lb)
MAX ZERO FUEL WEIGHT.....18500 kg (40786 lb)
BASIC OPERATING WEIGHT.....13100 kg (28881 lb)
MAX USABLE FUEL.....5987 kg (13199 lb)

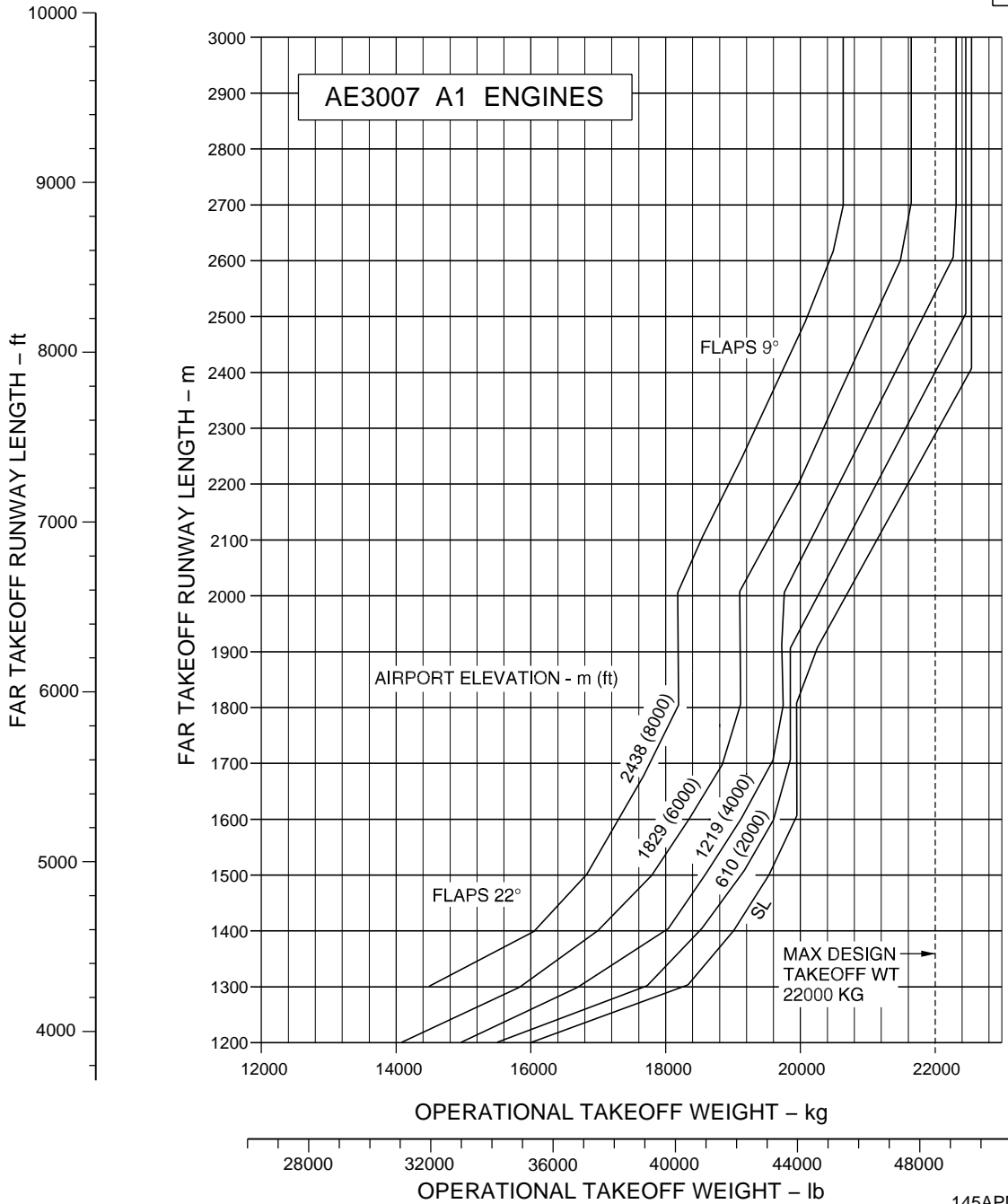
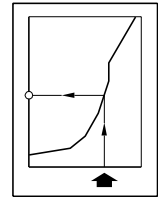
145APM030373.MCE

*Figure 3.2.1 - Payload x Range for Long Range Cruise at 37,000 ft, Engine with Thrust Reverser
Sheet 9*



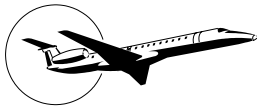
3.3 FAR Takeoff Runway Length Requirements

TAKEOFF RUNWAY LENGTH REQUIREMENTS
 FLAPS 9/22 T/O-1 MODE, NO ENGINE BLEED FOR
 AIR CONDITIONING
 DRY AND LEVELED RUNWAY, ZERO WIND
 ISA

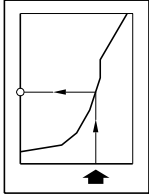


145APM030124.MCE E

Figure 3.3.1 - FAR Takeoff Runway Length Requirements - ISA Conditions
 Sheet 1



TAKEOFF RUNWAY LENGTH REQUIREMENTS
FLAPS 9/22 T/O-1 MODE, NO ENGINE BLEED FOR
AIR CONDITIONING
DRY AND LEVELED RUNWAY, ZERO WIND
ISA



AE3007 A1/1 ENGINES

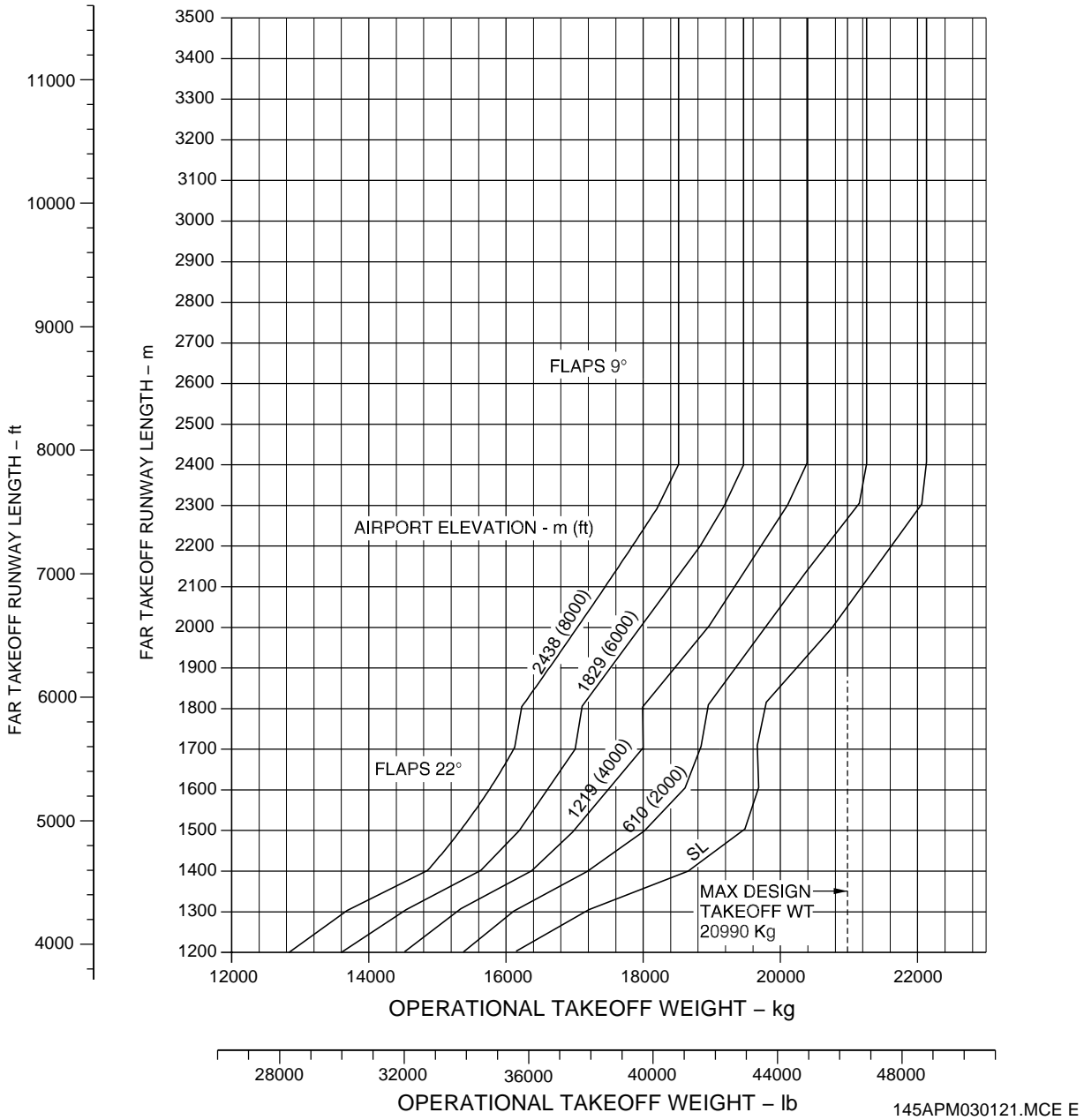
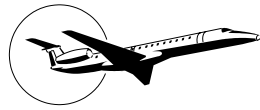


Figure 3.3.1 - FAR Takeoff Runway Length Requirements - ISA Conditions
Sheet 2



TAKEOFF RUNWAY LENGTH REQUIREMENTS
FLAPS 9/22 ET/O THRUST MODE, NO ENGINE BLEED FOR
AIR CONDITIONING
DRY AND LEVELED RUNWAY, ZERO WIND
ISA

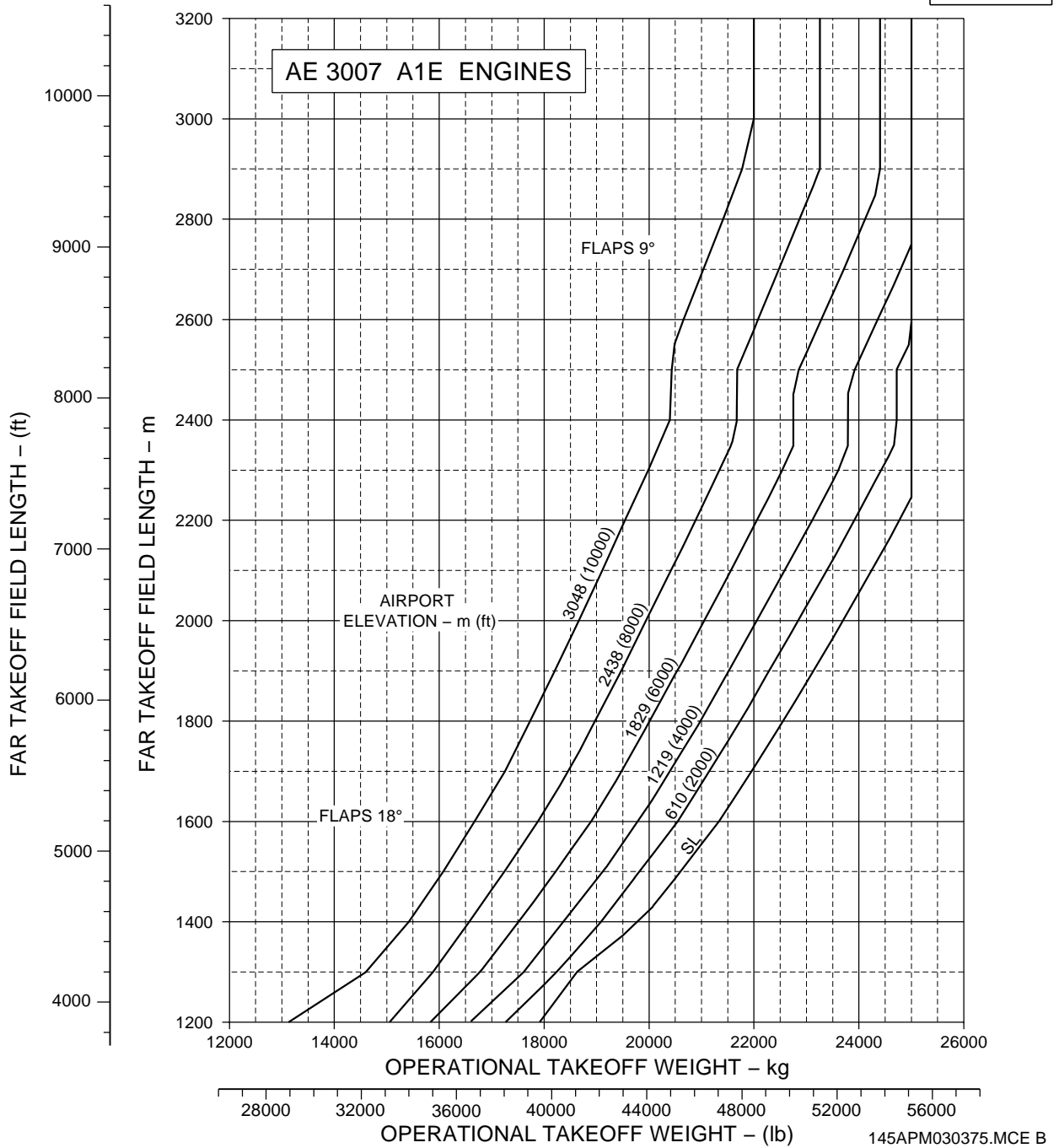
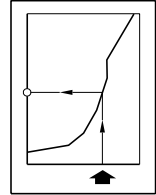
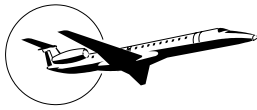


Figure 3.3.1 - FAR Takeoff Runway Length Requirements - ISA Conditions
Sheet 3



TAKEOFF RUNWAY LENGTH REQUIREMENTS
 FLAPS 9/18/22 T/O MODE, NO ENGINE BLEED FOR
 AIR CONDITIONING
 DRY AND LEVELED RUNWAY, ZERO WIND
 ISA

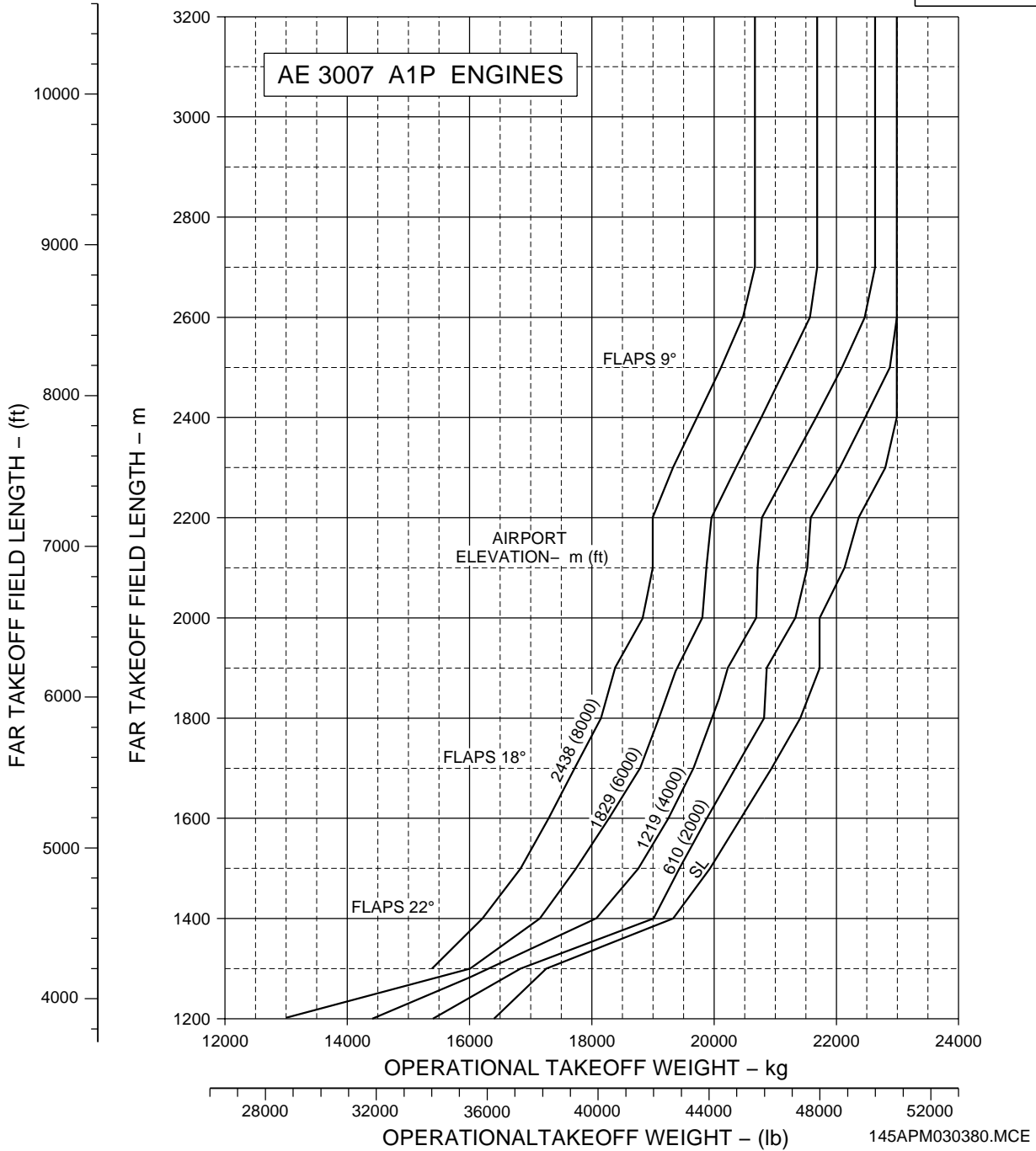
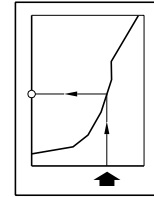
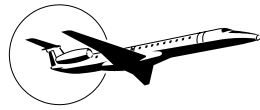


Figure 3.3.1 - FAR Takeoff Runway Length Requirements - ISA Conditions
 Sheet 4



TAKEOFF RUNWAY LENGTH REQUIREMENTS
 FLAPS 9/22 T/O-1 MODE, NO ENGINE BLEED FOR
 AIR CONDITIONING
 DRY AND LEVELED RUNWAY, ZERO WIND
 ISA+15°C

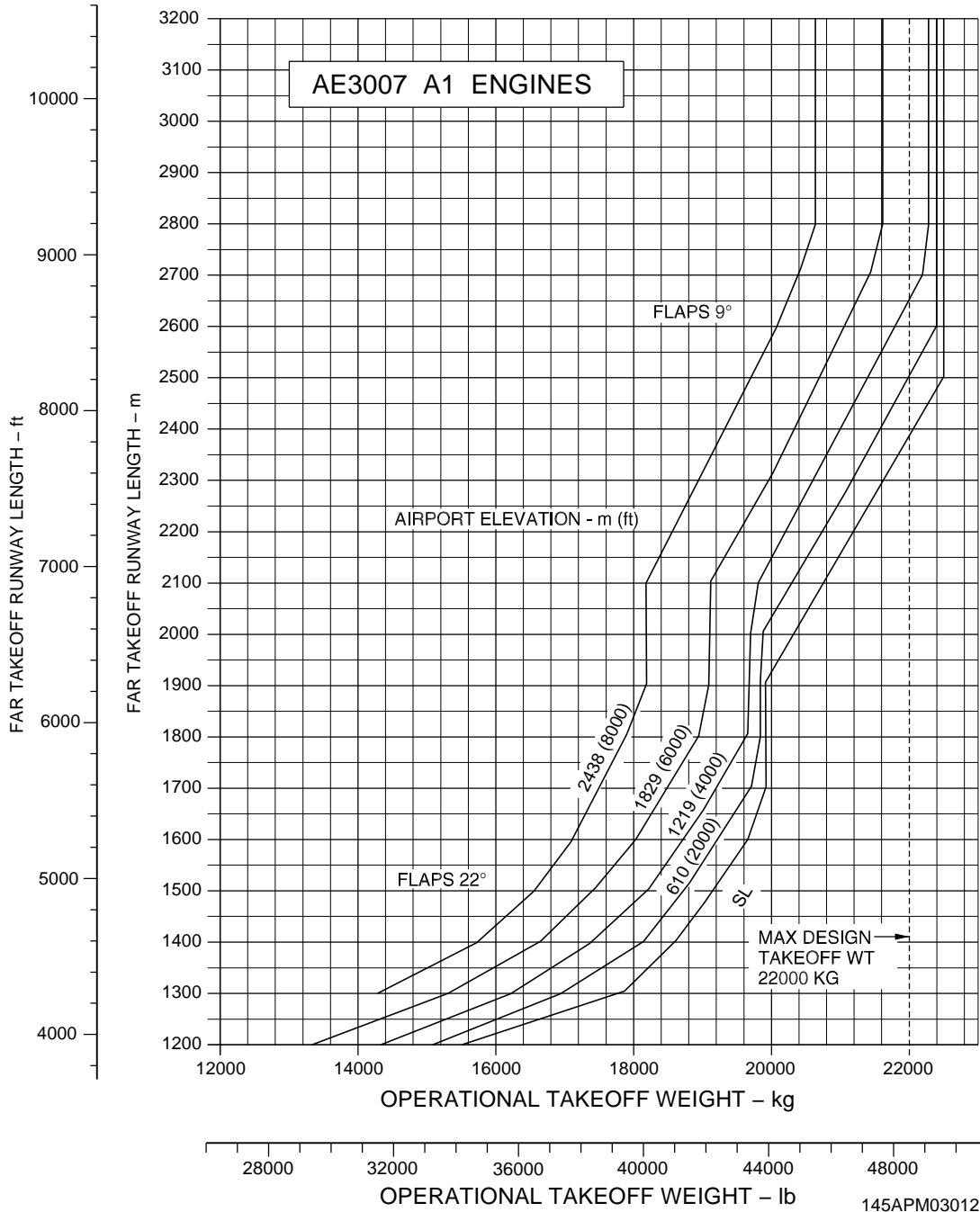
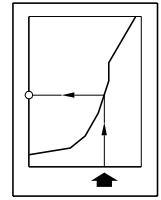


Figure 3.3.2 - FAR Takeoff Runway Length Requirements - ISA + 15°C Conditions
 Sheet 1



TAKEOFF RUNWAY LENGTH REQUIREMENTS
 FLAPS 9/22 T/O-1 MODE, NO ENGINE BLEED FOR
 AIR CONDITIONING
 DRY AND LEVELED RUNWAY, ZERO WIND
 ISA+15°C

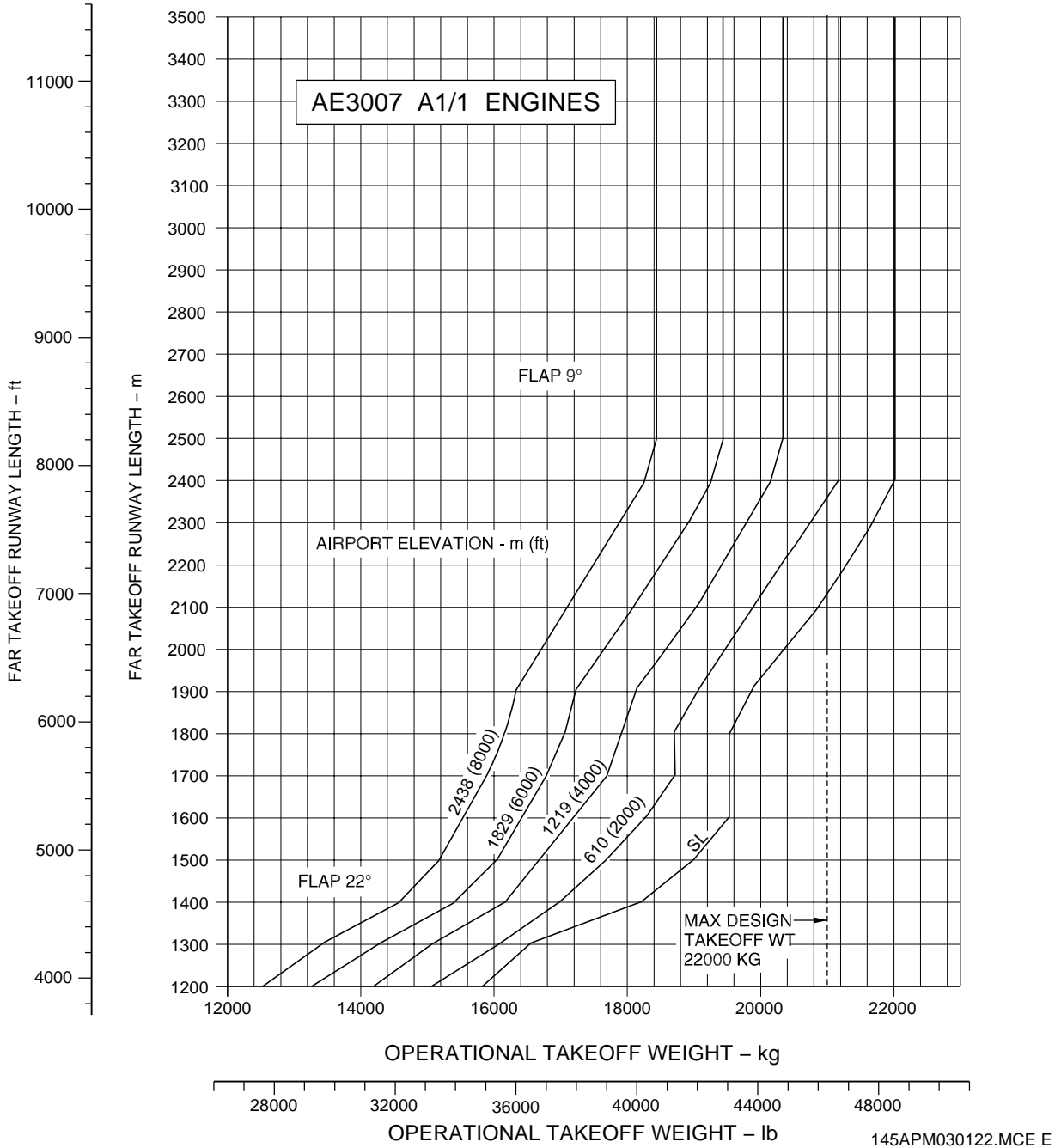
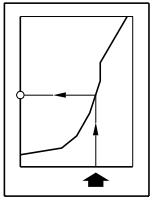
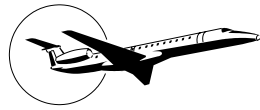


Figure 3.3.2 - FAR Takeoff Runway Length Requirements - ISA + 15°C Conditions
 Sheet 2



TAKEOFF RUNWAY LENGTH REQUIREMENTS
FLAPS 9/22 ET/O THRUST MODE, NO ENGINE BLEED FOR
AIR CONDITIONING
DRY AND LEVELED RUNWAY, ZERO WIND
ISA+15°C

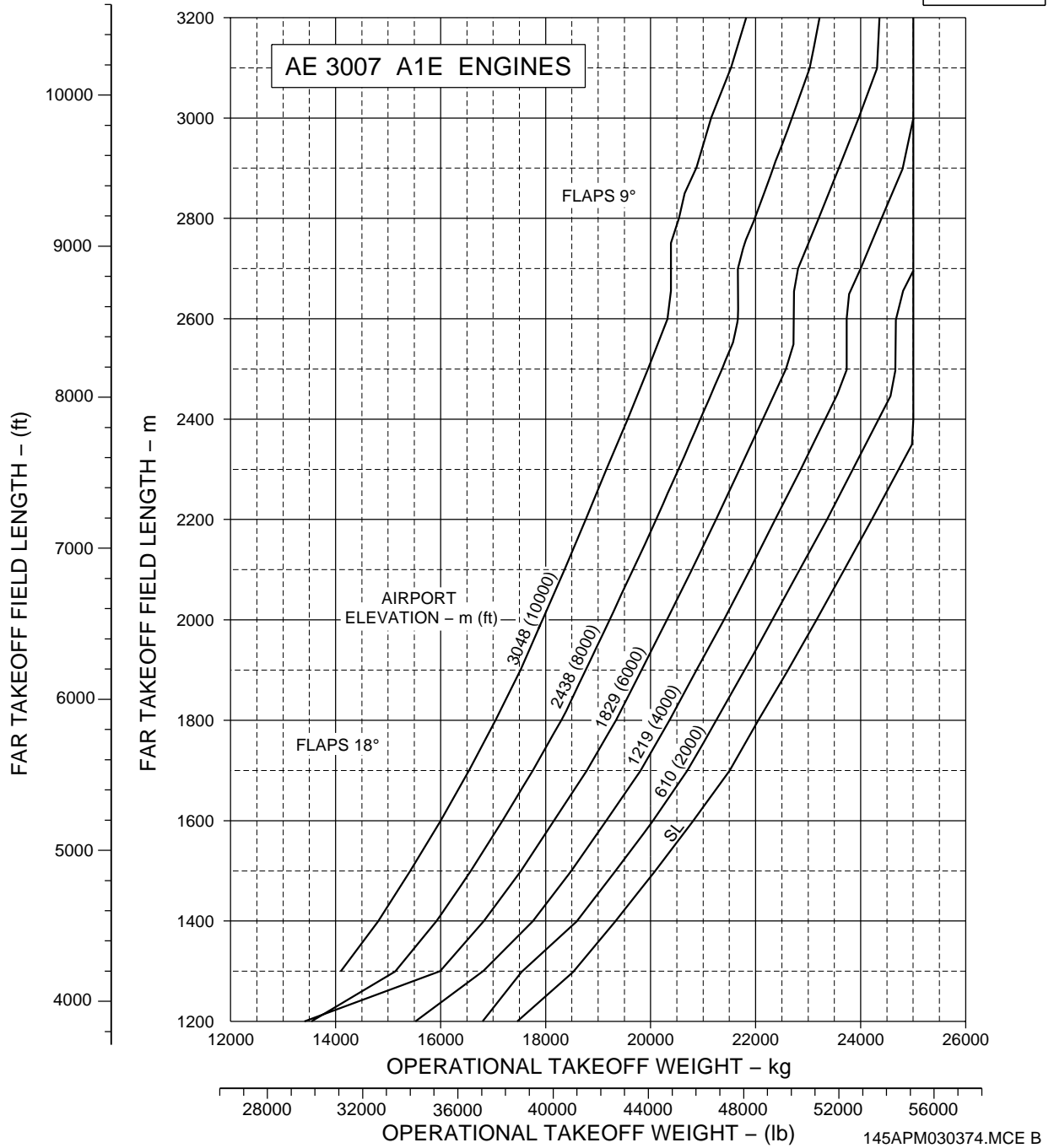
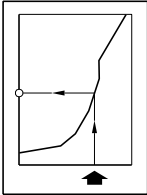
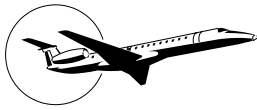


Figure 3.3.2 - FAR Takeoff Runway Length Requirements - ISA + 15°C Conditions
Sheet 3



TAKEOFF RUNWAY LENGTH REQUIREMENTS
 FLAPS 9/18/22 T/O MODE, NO ENGINE BLEED FOR
 AIR CONDITIONING
 DRY AND LEVELED RUNWAY, ZERO WIND
 ISA+15°C

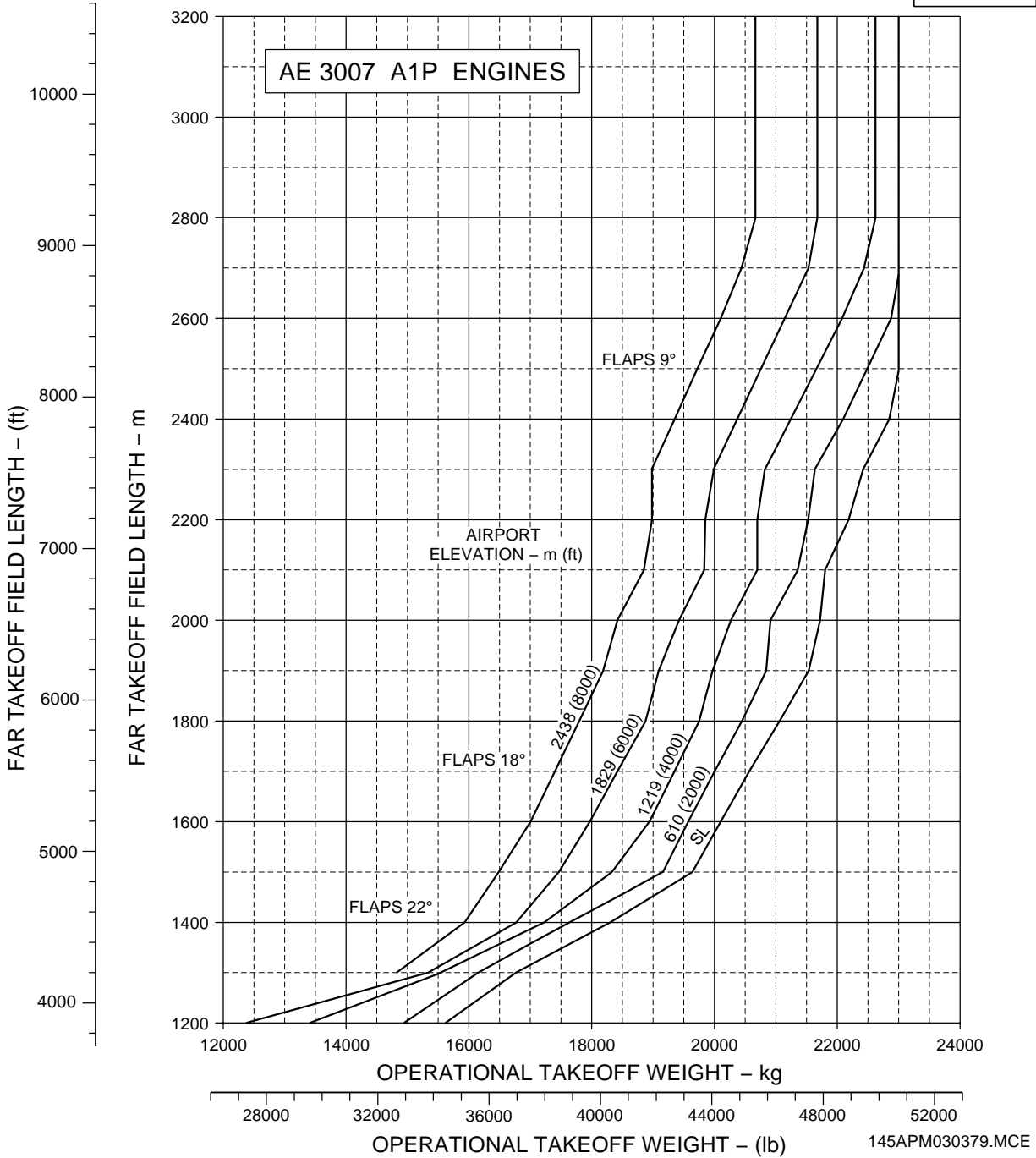
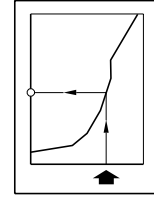
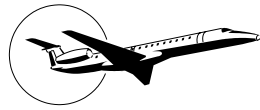
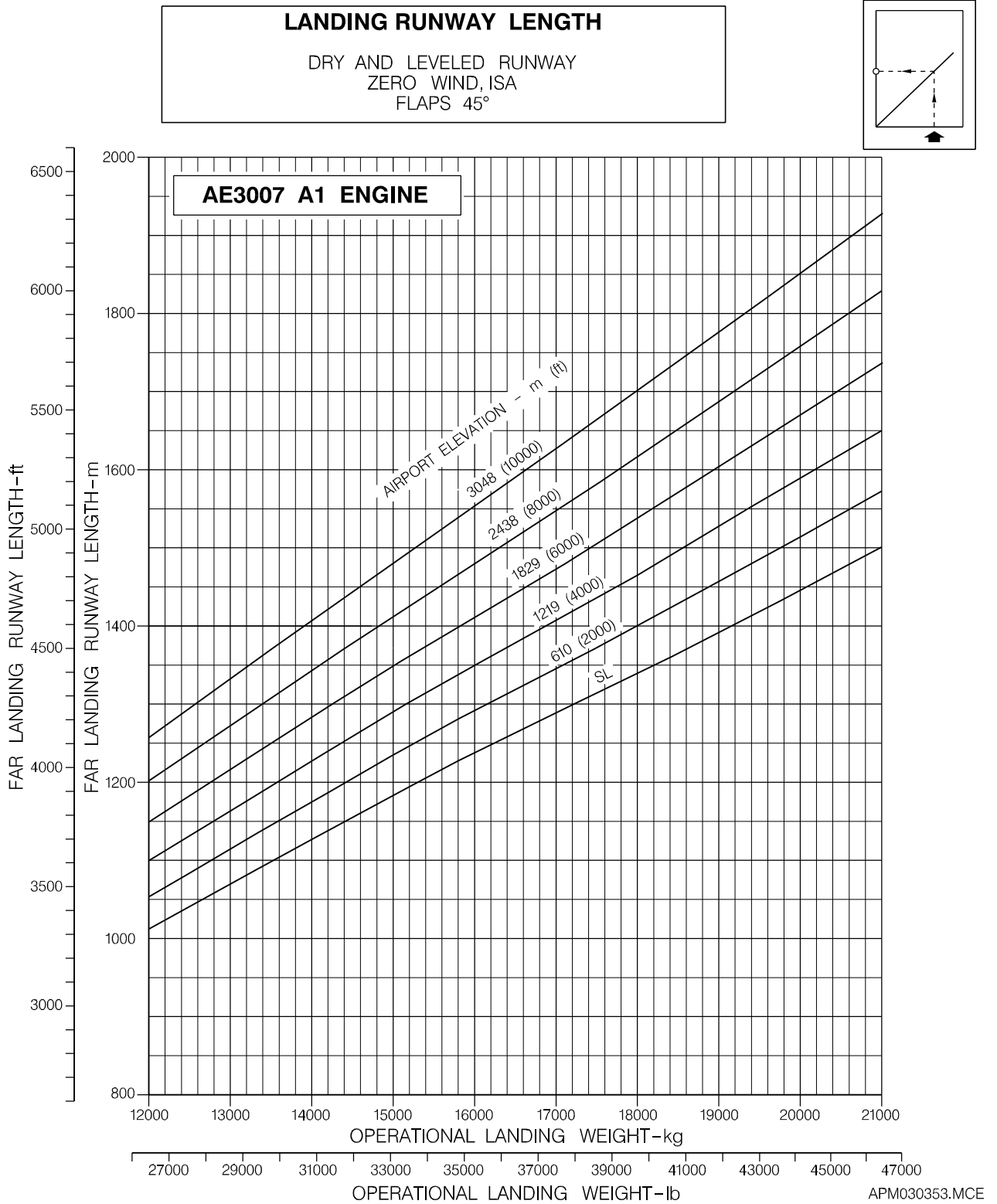


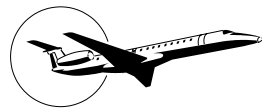
Figure 3.3.2 - FAR Takeoff Runway Length Requirements - ISA + 15°C Conditions
 Sheet 4



3.4 FAR Landing Runway Length Requirements



*Figure 3.4.1 - FAR Landing Runway Length Requirements - Flaps 45°
Sheet 1*



LANDING RUNWAY LENGTH
 DRY AND LEVELED RUNWAY
 ZERO WIND, ISA
 FLAPS 45°

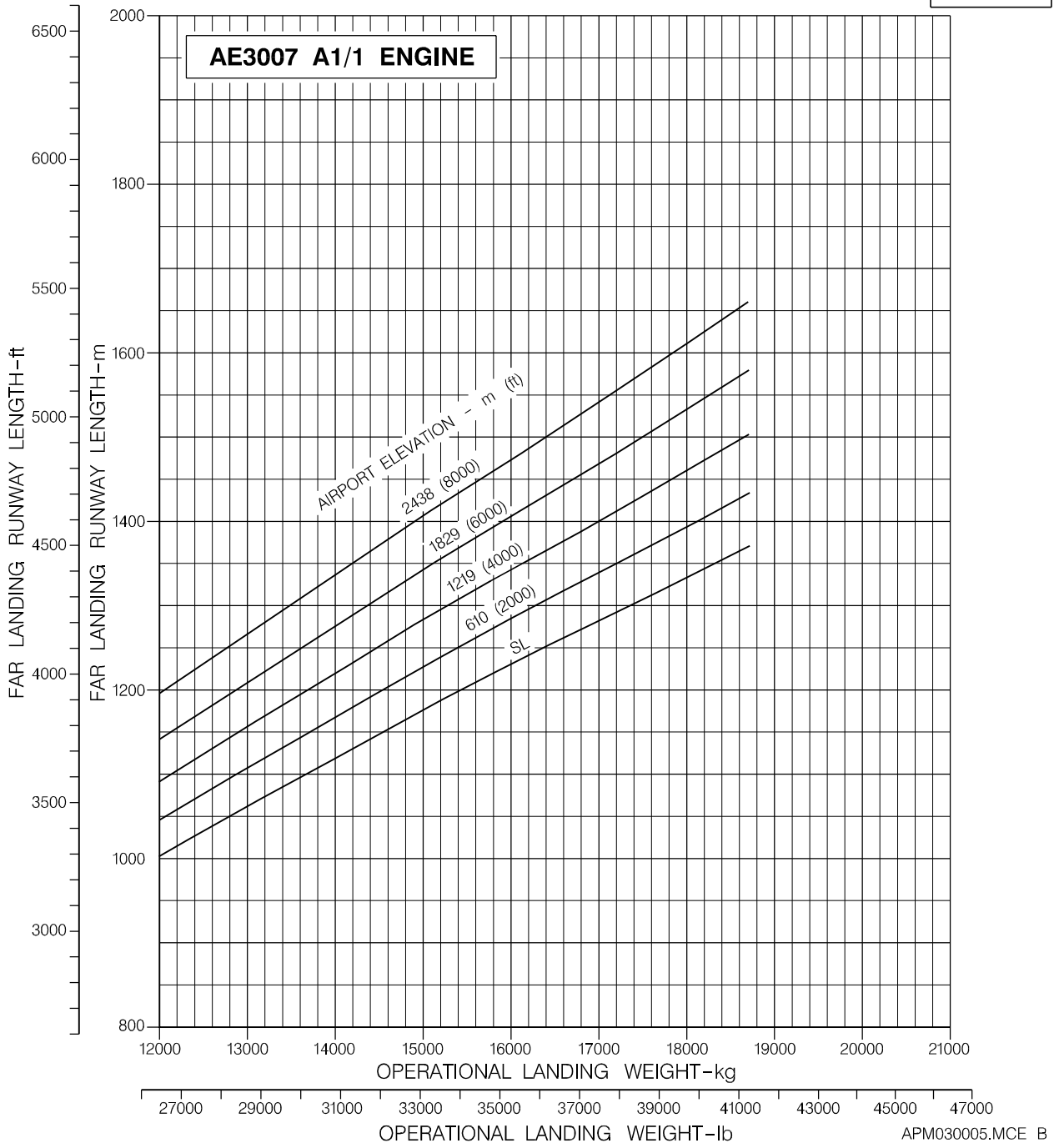
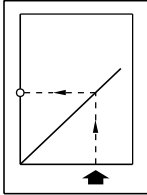
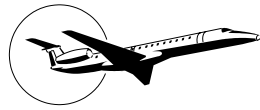


Figure 3.4.1 - FAR Landing Runway Length Requirements - Flaps 45°
Sheet 2



LANDING RUNWAY LENGTH
 DRY AND LEVELED RUNWAY
 ZERO WIND, ISA
 FLAPS 45°

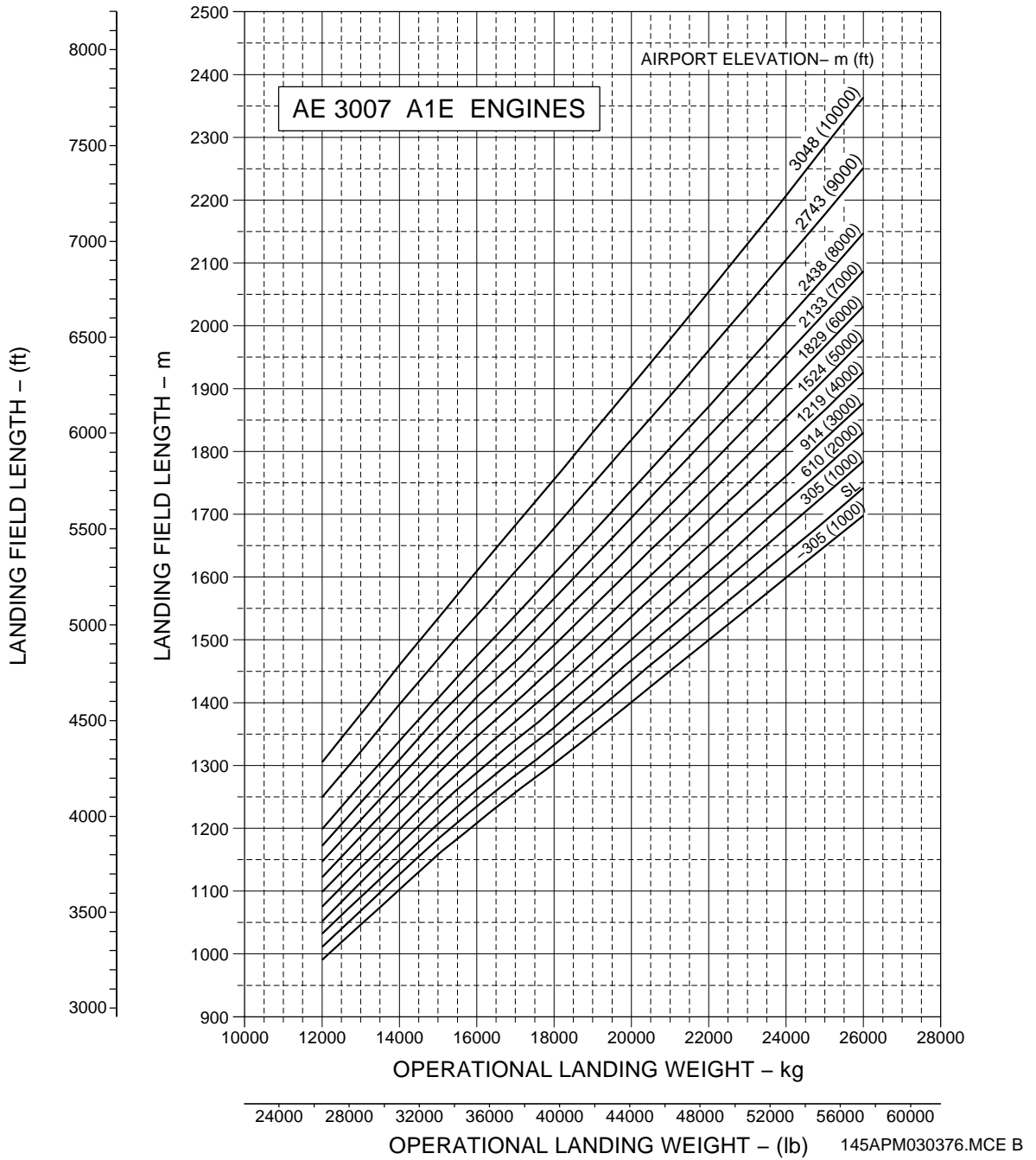
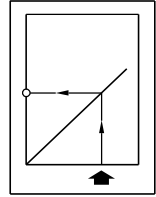


Figure 3.4.1 - FAR Landing Runway Length Requirements - Flaps 45°
 Sheet 3

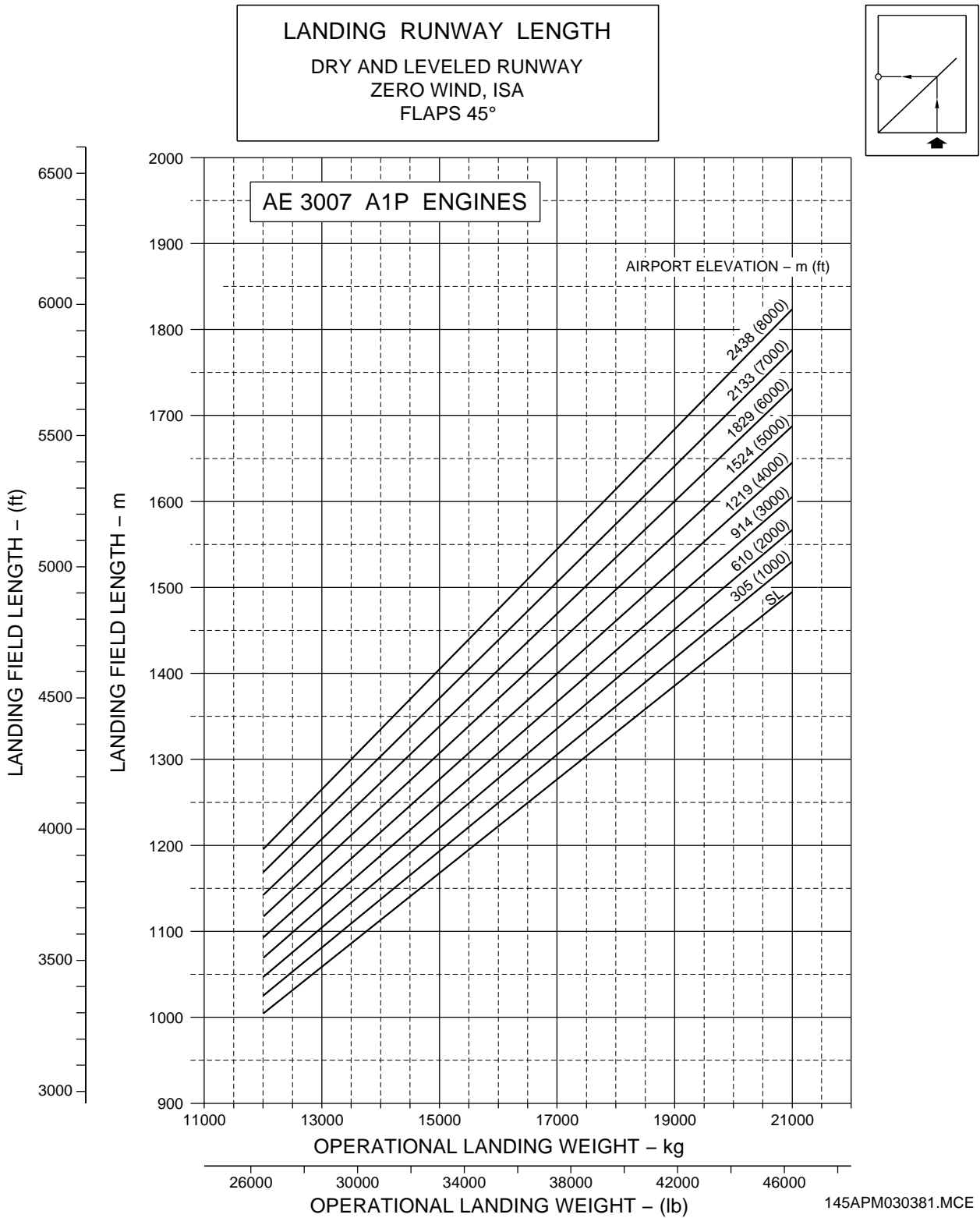
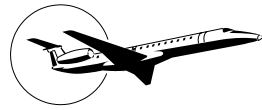
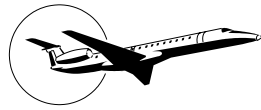


Figure 3.4.1 - FAR Landing Runway Length Requirements - Flaps 45°
Sheet 4



4. GROUND MANEUVERING

4.1 General Information

This section provides the airplane turning capability and maneuvering characteristics. For ease of presentation, these data have been determined from theoretical limits imposed by the geometry of the aircraft.

As such, they reflect the turning capability of the aircraft in favorable operating circumstances. These data should be used only as guidelines for the method of determination of such parameters and for the maneuvering characteristics of the EMB-145.

In the ground operating mode, varying airline practices may demand that more conservative turning procedures be adopted to avoid excessive tire wear and reduce possible maintenance problems. Airline operating techniques will vary, as far as the performance is concerned, over a wide range of operating circumstances throughout the world.

Variations from standard aircraft operating patterns may be necessary to satisfy physical constants within the maneuvering area, such as adverse grades, limited area, or high risk of jet blast damage. For these reasons, the ground maneuvering requirements should be coordinated with the using airline prior to the layout planning.

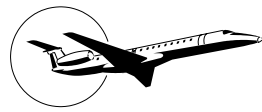
Section 4.2 presents the turning radii for various nose gear steering angles.

Section 4.3 presents data on the minimum width of the pavement for 180° turn.

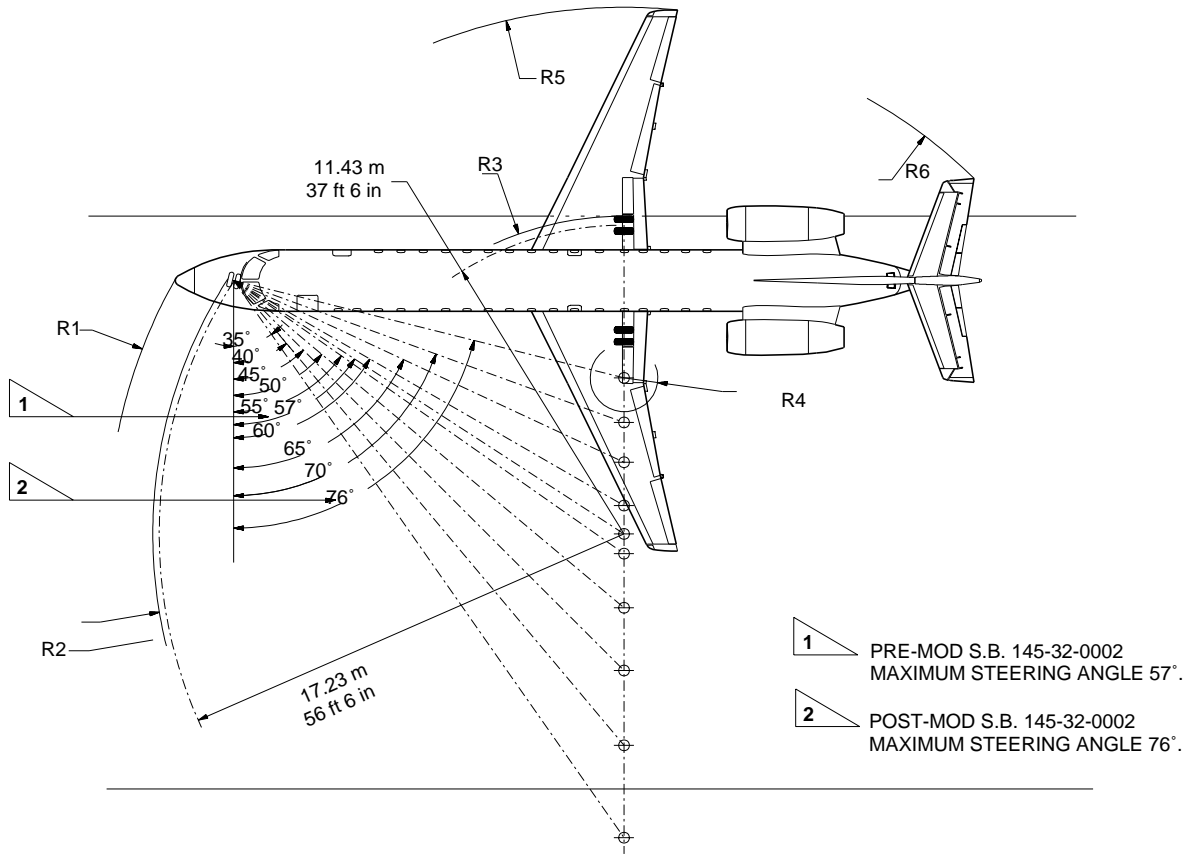
Section 4.4 presents the pilot's visibility from the cockpit and the limits of ambinoocular vision through the windows. Ambinoocular vision is defined as the total field of vision seen by both eyes at the same time.

Section 4.5 presents the performance of the EMB-145 on runway-to-taxiway and taxiway-to-taxiway turn paths.

Section 4.6 presents the runway holding bay configuration.



4.2 Turning Radii - No Slip Angle



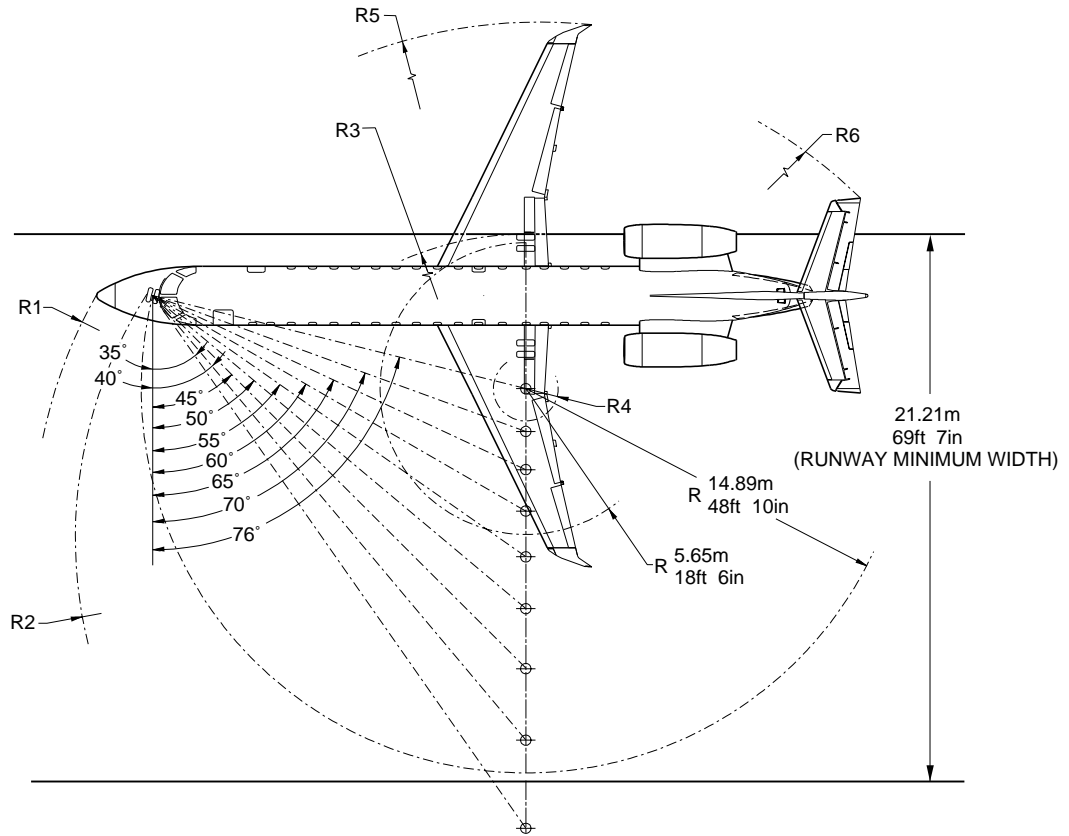
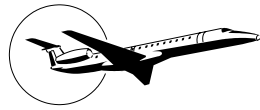
TURNING CENTERS

STEERING ANGLE	NOSE R1		NOSE GEAR R2		OUTBOARD GEAR R3		INBOARD GEAR R4		RIGHT WINGTIP R5		RIGHT TAILTIP R6	
35°	26.56 m	87 ft 2 in	25.41 m	83 ft 4 in	23.02 m	75 ft 6 in	18.25 m	59 ft 10 in	30.72 m	100 ft 9 in	27.64 m	90 ft 8 in
40°	23.99 m	78 ft 8 in	22.70 m	74 ft 6 in	19.60 m	64 ft 4 in	14.84 m	48 ft 8 in	27.31 m	89 ft 7 in	24.68 m	80 ft 11 in
45°	22.07 m	72 ft 5 in	20.66 m	67 ft 9 in	16.83 m	55 ft 3 in	12.07 m	39 ft 7 in	24.55 m	80 ft 6 in	22.37 m	73 ft 4 in
50°	20.61 m	67 ft 7 in	19.08 m	62 ft 7 in	14.51 m	47 ft 7 in	9.74 m	31 ft 11 in	22.23 m	72 ft 11 in	20.52 m	67 ft 4 in
55°	19.48 m	63 ft 11 in	17.86 m	58 ft 7 in	12.50 m	41 ft 0 in	7.74 m	25 ft 5 in	20.24 m	66 ft 5 in	19.00 m	62 ft 4 in
57°	19.11 m	62 ft 8 in	17.45 m	57 ft 3 in	11.77 m	38 ft 7 in	7.00 m	23 ft 0 in	19.51 m	64 ft 0 in	18.47 m	60 ft 7 in
60°	18.62 m	61 ft 1 in	16.90 m	55 ft 5 in	10.73 m	35 ft 2 in	5.96 m	19 ft 6 in	18.47 m	60 ft 7 in	17.75 m	58 ft 3 in
65°	17.95 m	58 ft 11 in	16.16 m	53 ft 0 in	9.12 m	29 ft 11 in	4.35 m	14 ft 3 in	16.88 m	55 ft 4 in	16.69 m	54 ft 9 in
70°	17.44 m	57 ft 2 in	15.6 m	51 ft 2 in	7.64 m	25 ft 1 in	2.87 m	9 ft 5 in	15.4 m	50 ft 7 in	15.8 m	51 ft 10 in
76°	17.01 m	55 ft 9 in	15.11 m	49 ft 7 in	5.99 m	19 ft 8 in	1.25 m	4 ft 1 in	13.77 m	45 ft 2 in	14.92 m	48 ft 11 in

EMB-145 EP/ER/EU/MP/MK/LR/LU

145APM000039.MCE A

*Figure 4.2.1 - Turning Radii - No Slip Angle
Sheet 1*

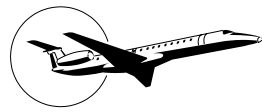


STEERING ANGLE	NOSE		NOSE GEAR		OUTBOARD GEAR		INBOARD GEAR		RIGHT WINGTIP		RIGHT TAILTIP	
	R1	R2	R2	R3	R3	R4	R4	R5	R5	R6	R6	
35°	26.56 m	87ft 2in	25.41 m	83ft 4in	23.02 m	75ft 6in	18.25 m	59ft 10in	31.24 m	102ft 6in	27.64 m	90ft 8in
40°	23.99 m	78ft 8in	22.70 m	74ft 6in	19.60 m	64ft 4in	14.84 m	48ft 8in	27.84 m	91ft 4in	24.68 m	80ft 11in
45°	22.07 m	72ft 5in	20.66 m	67ft 9in	16.83 m	55ft 3in	12.07 m	39ft 7in	25.08 m	82ft 3in	22.37 m	73ft 4in
50°	20.61 m	67ft 7in	19.08 m	62ft 7in	14.51 m	47ft 7in	9.74 m	31ft 11in	22.77 m	74ft 8in	20.52 m	67ft 4in
55°	19.48 m	63ft 11in	17.86 m	58ft 7in	12.50 m	41ft 0in	7.74 m	25ft 5in	20.78 m	68ft 2in	19.00 m	62ft 4in
60°	18.62 m	61ft 1in	16.90 m	55ft 5in	10.73 m	35ft 2in	5.96 m	19ft 6in	19.02 m	62ft 5in	17.75 m	58ft 3in
65°	17.95 m	58ft 11in	16.16 m	53ft 0in	9.12 m	29ft 1in	4.35 m	14ft 3in	17.43 m	57ft 2in	16.69 m	54ft 9in
70°	17.44 m	57ft 2in	15.6 m	51ft 2in	7.64 m	25ft 1in	2.87 m	9ft 5in	15.97 m	52ft 5in	15.8 m	51ft 10in
76°	17.01 m	55ft 9in	15.11 m	49ft 7in	5.99 m	19ft 8in	1.25 m	4ft 1in	14.33 m	47ft 0in	14.92 m	48ft 11in

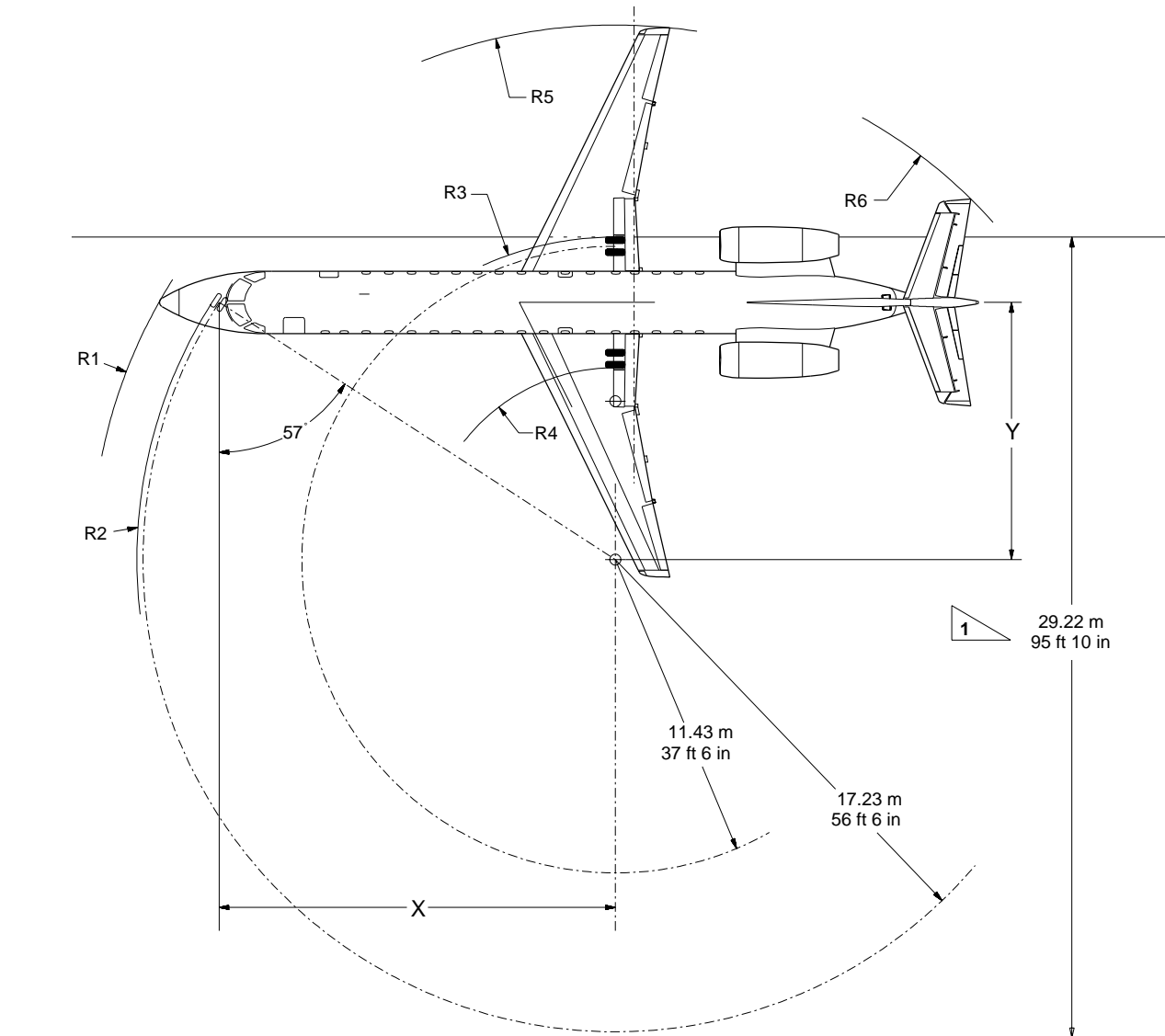
EMB-145XR

145APM040462.MCE

*Figure 4.2.1 - Turning Radii - No Slip Angle
Sheet 2*



4.3 Minimum Turning Radii



STEERING ANGLE	NOSE R1		NOSE GEAR R2		OUTBOARD GEAR R3		INBOARD GEAR R4		RIGHT WINGTIP R5		RIGHT TAILTIP R6	
57°	19.11 m	62 ft 8 in	17.45 m	57 ft 3 in	11.77 m	38 ft 7 in	7.00 m	23 ft 0 in	19.51 m	64 ft 0 in	18.47 m	60 ft 7 in

X		Y	
14.45 m	47 ft 5 in	9.38 m	30 ft 9 in

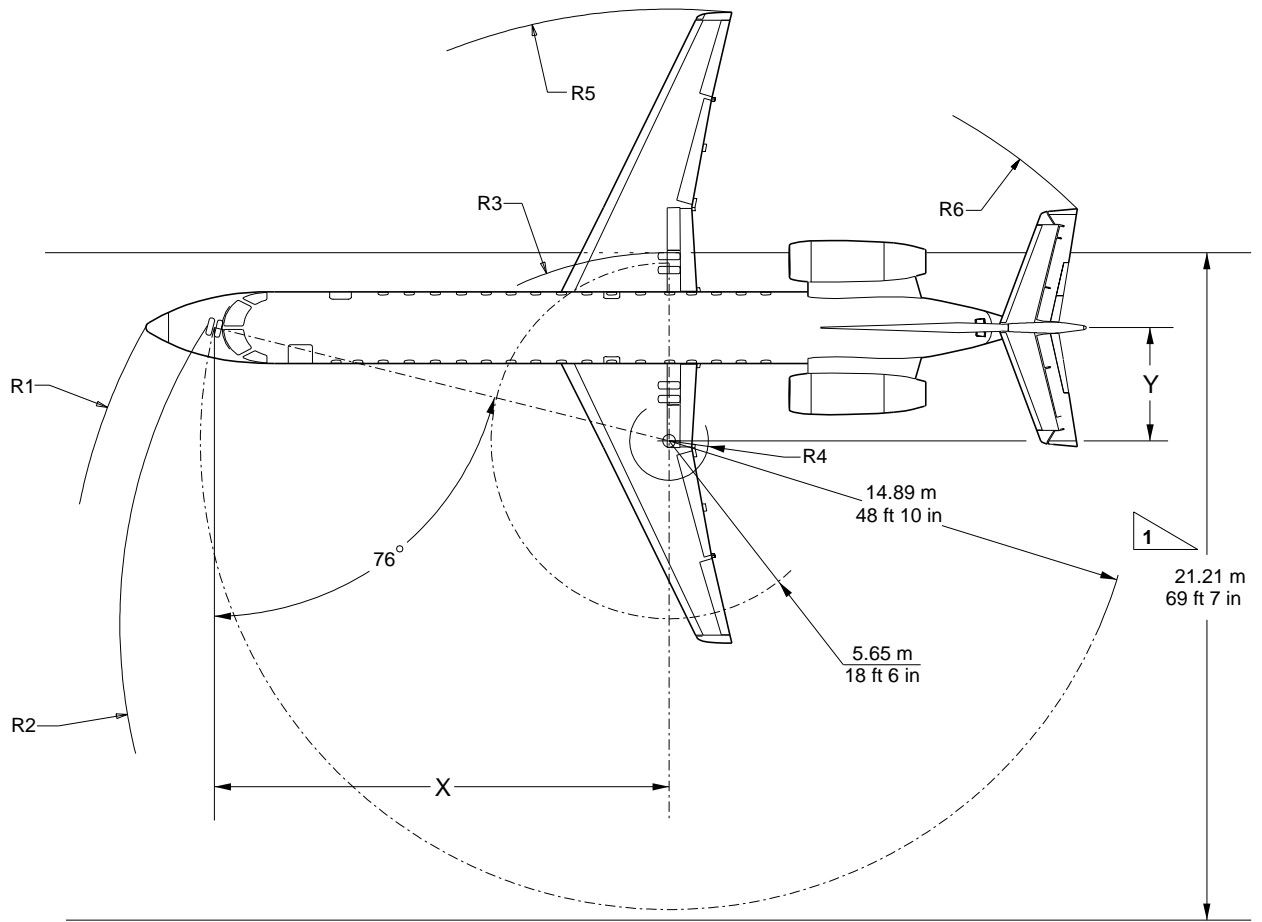
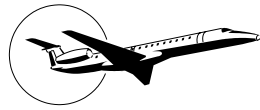
NOTE: THE CORRECT OPERATING DATA WILL BE HIGHER THAN THE VALUES SHOWN BECAUSE TIRE SLIPPAGE IS NOT INCLUDED IN THIS CALCULATION.

PAVEMENT WIDTH FOR 180° TURN

EMB-145 EP/ER/EU/MP/MK/LR/LU

145APM000040.MCE A

Figure 4.3.1 - Minimum Turning Radii - PRE-MOD. S.B. 145-32-0002



STEERING ANGLE	NOSE R1		NOSE GEAR R2		OUTBOARD GEAR R3		INBOARD GEAR R4		RIGHT WINGTIP R5		RIGHT TAILTIP R6	
76°	17.01 m	55 ft 9 in	15.11 m	49 ft 7 in	5.99 m	19 ft 8 in	1.25 m	4 ft 1 in	13.77 m	45 ft 2 in	14.92 m	48 ft 11 in

X		Y	
14.45 m	47 ft 5 in	3.6 m	11 ft 10 in

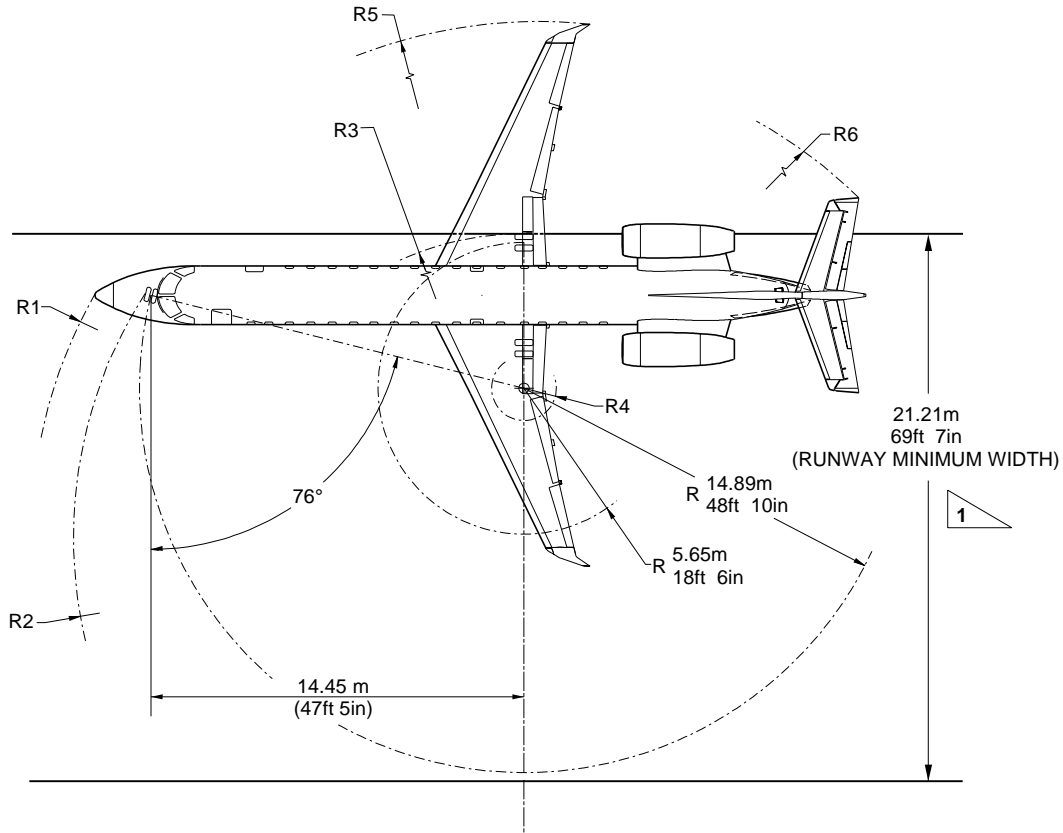
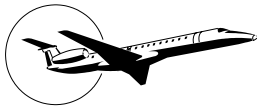
NOTE: THE CORRECT OPERATING DATA WILL BE HIGHER THAN THE VALUES SHOWN BECAUSE TIRE SLIPPAGE IS NOT INCLUDED IN THIS CALCULATION.

PAVEMENT WIDTH FOR 180° TURN

EMB-145 EP/ER/EU/MP/MK/LR/LU

145APM000042.MCE B

Figure 4.3.2 - Minimum Turning Radii - POST-MOD. S.B. 145-32-0002



STEERING ANGLE	NOSE		NOSE GEAR		OUTBOARD GEAR		INBOARD GEAR		RIGHT WINGTIP		RIGHT TAILTIP	
	R1	R2	R3	R4	R5	R6						
76°	17.01 m	55ft 9in	15.11 m	49ft 7in	5.99 m	19ft 8in	1.25 m	4ft 1in	14.33 m	47ft 0in	14.92 m	48ft 11in

NOTE: ACTUAL OPERATING DATA WILL BE GREATER THAN VALUES SHOWN SINCE TIRE SLIPPAGE IS NOT CONSIDERED IN THIS CALCULATION.

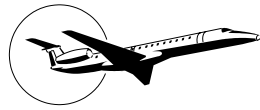


PAVEMENT WIDTH FOR 180° TURN

EMB-145XR

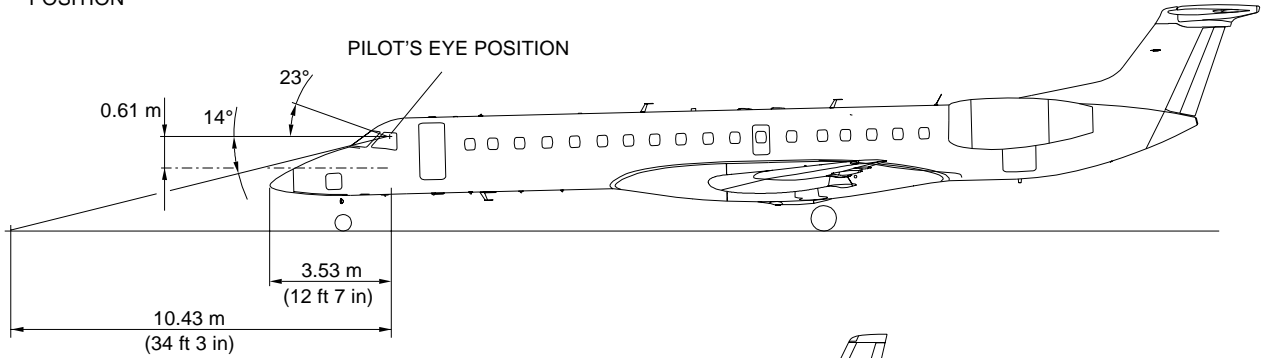
145APM040463.MCE A

Figure 4.3.3 - Minimum Turning Radii

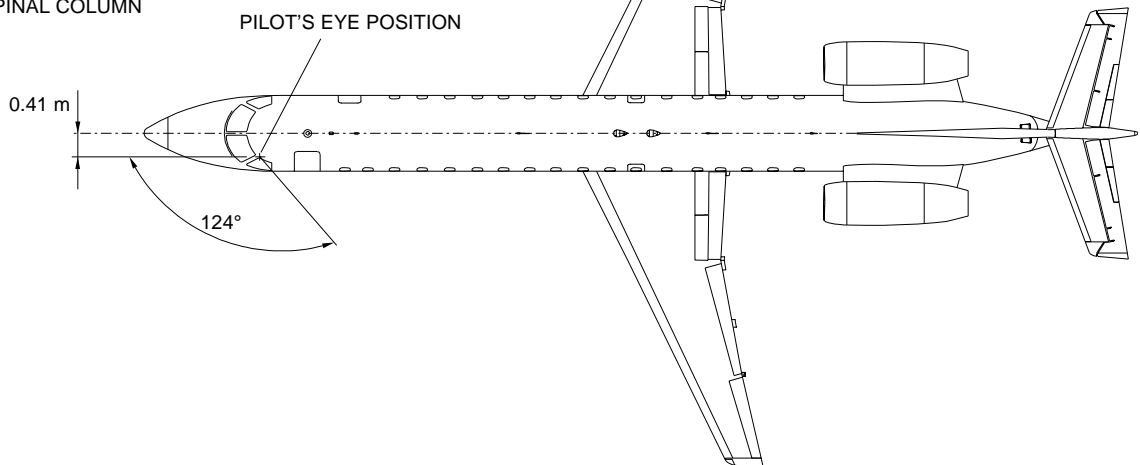


4.4 Visibility from Cockpit in Static Position

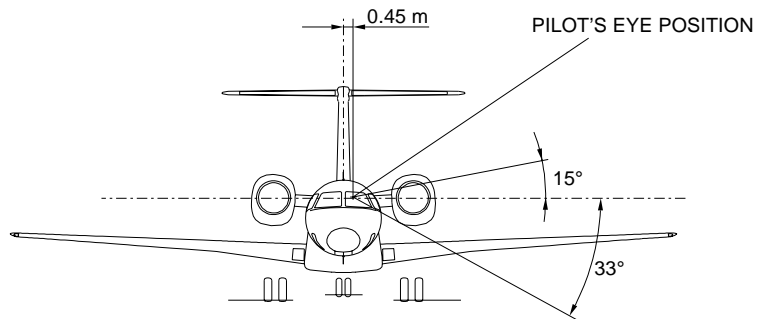
VISUAL ANGLES IN PLANE
 PARALLEL TO LONGITUDINAL
 AXIS THROUGH PILOT'S EYE
 POSITION



MAXIMUM AFT VISION
 WITH HEAD ROTATED
 ABOUT SPINAL COLUMN

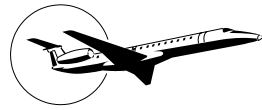


VISUAL ANGLE IN PLANE
 PERPENDICULAR TO LONGITUDINAL
 AXIS THROUGH PILOT'S EYE POSITION



145APM000015.MCE A

Figure 4.4.1 - Visibility from Cockpit in Static Position



4.5 Runway and Taxiway Turn Paths

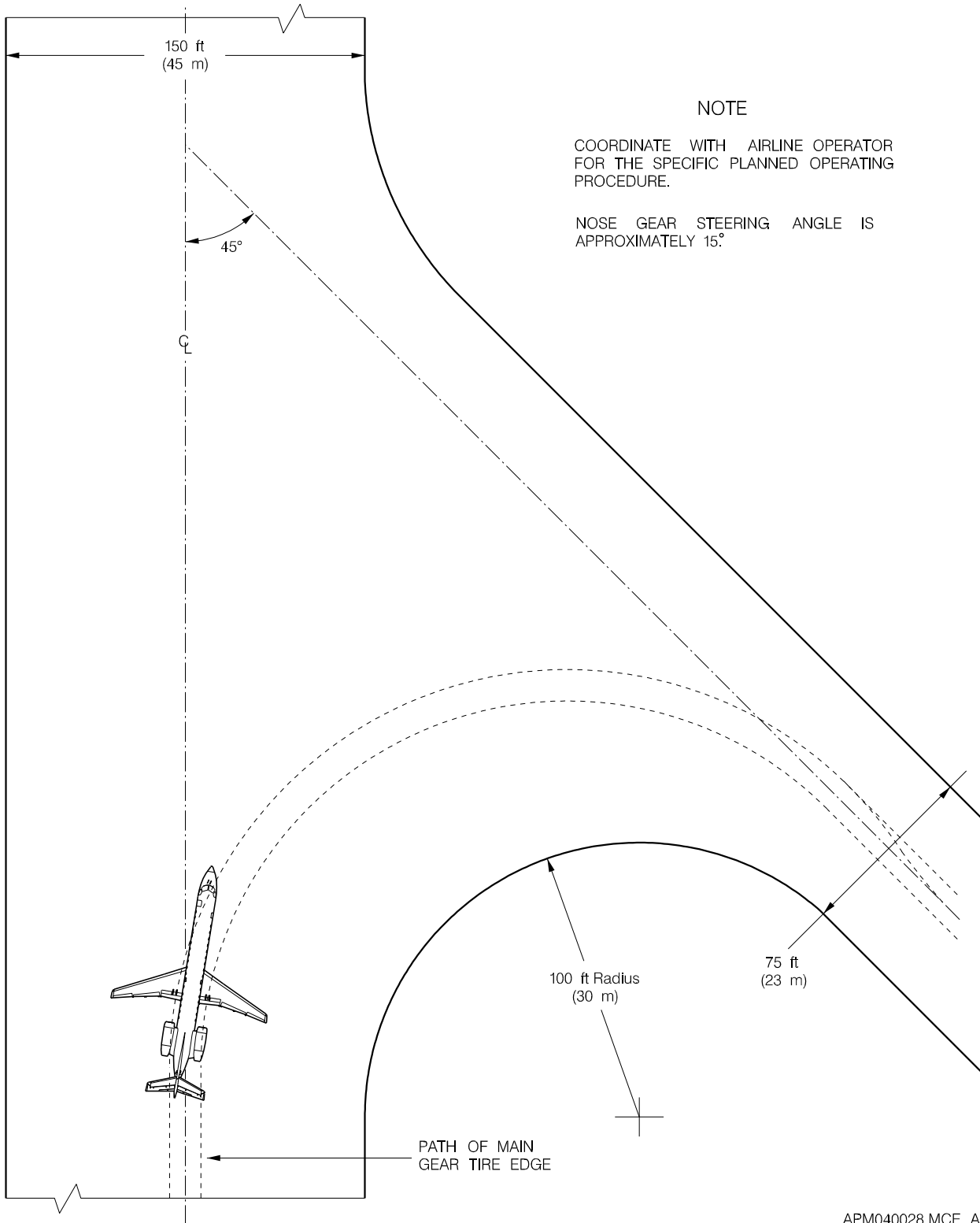
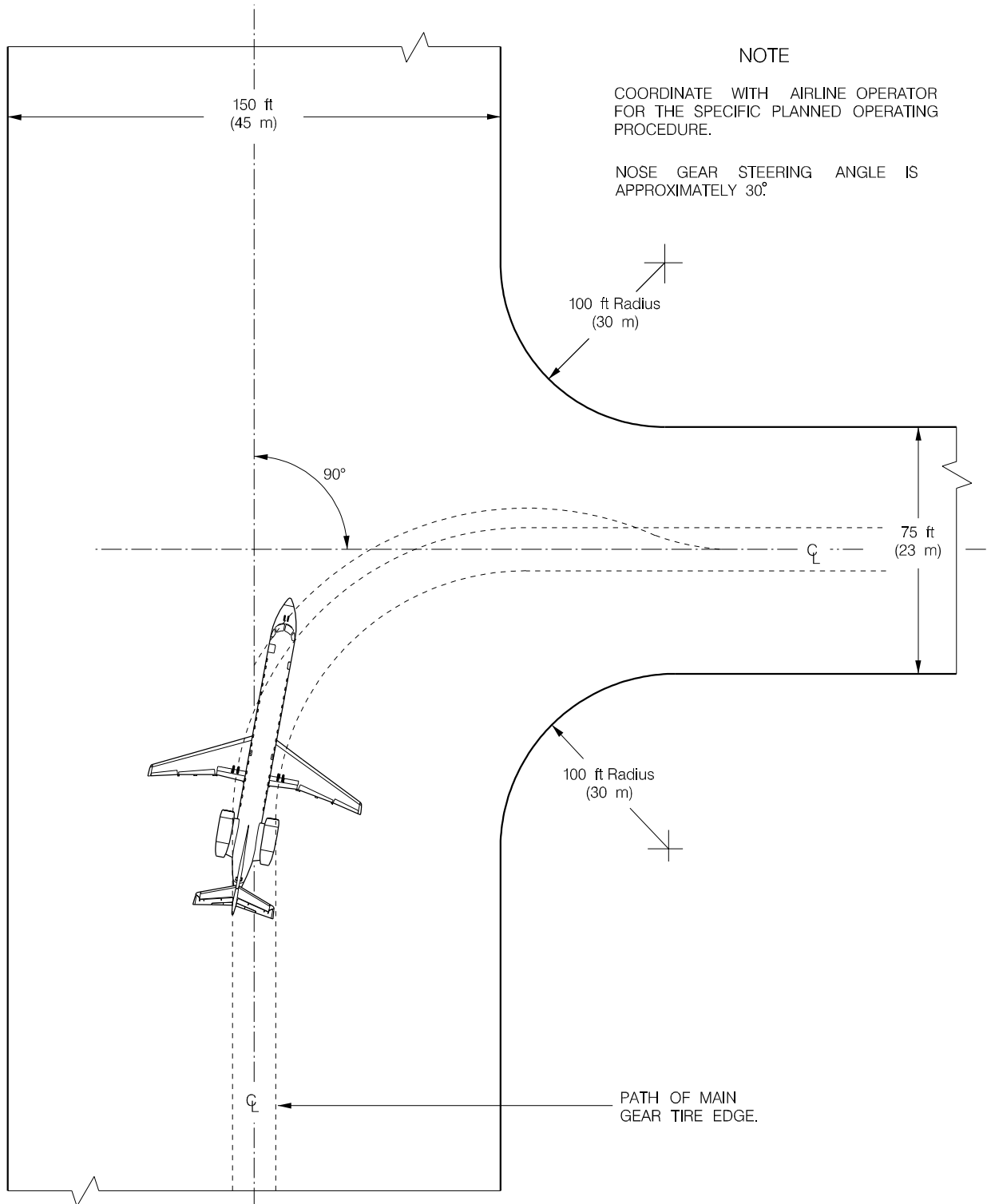
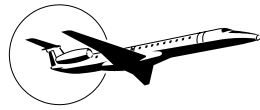
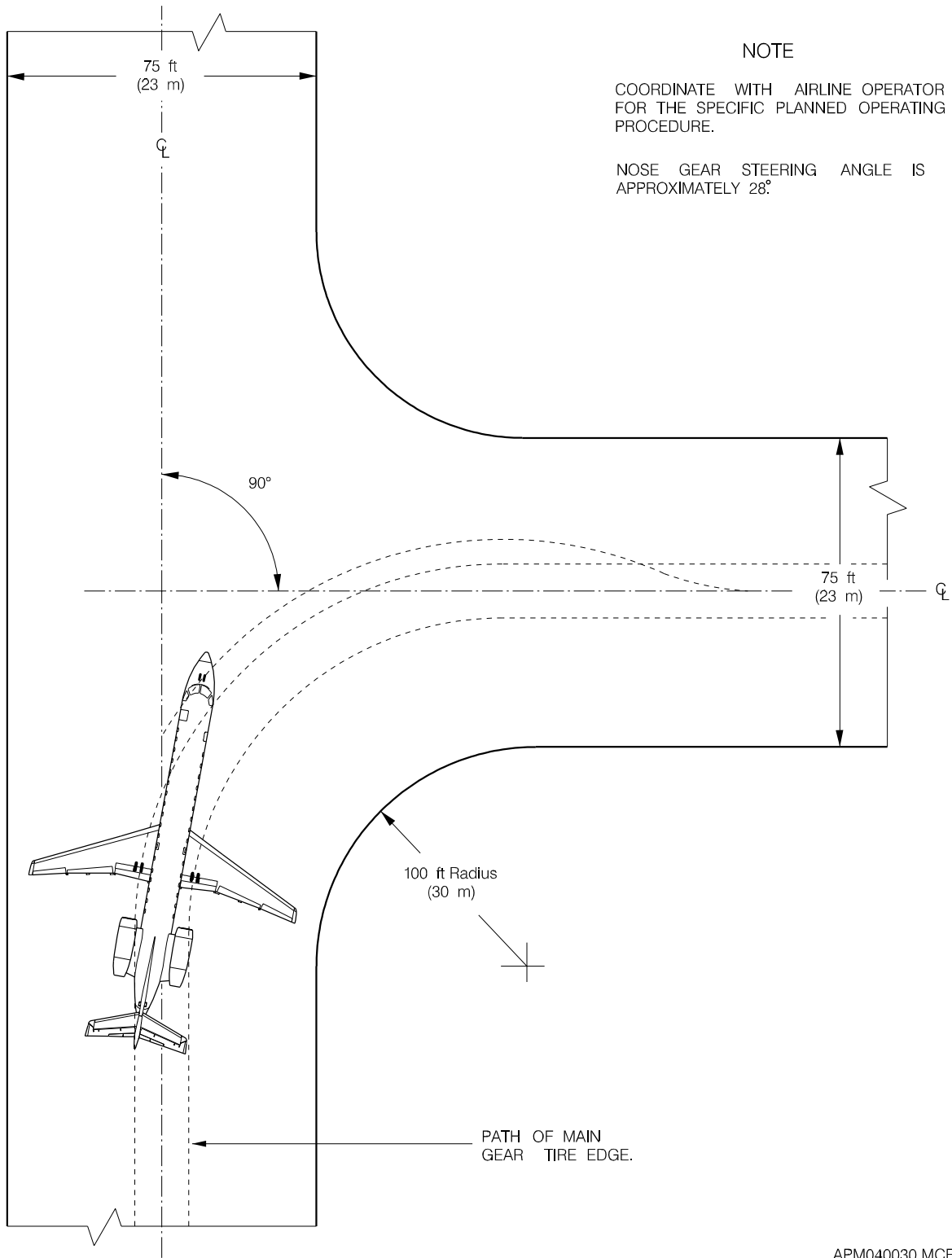


Figure 4.5.1 - More than 90° Turn - Runway to Taxiway



APM040029.MCE A

Figure 4.5.2 - 90° Turn - Runway to Taxiway

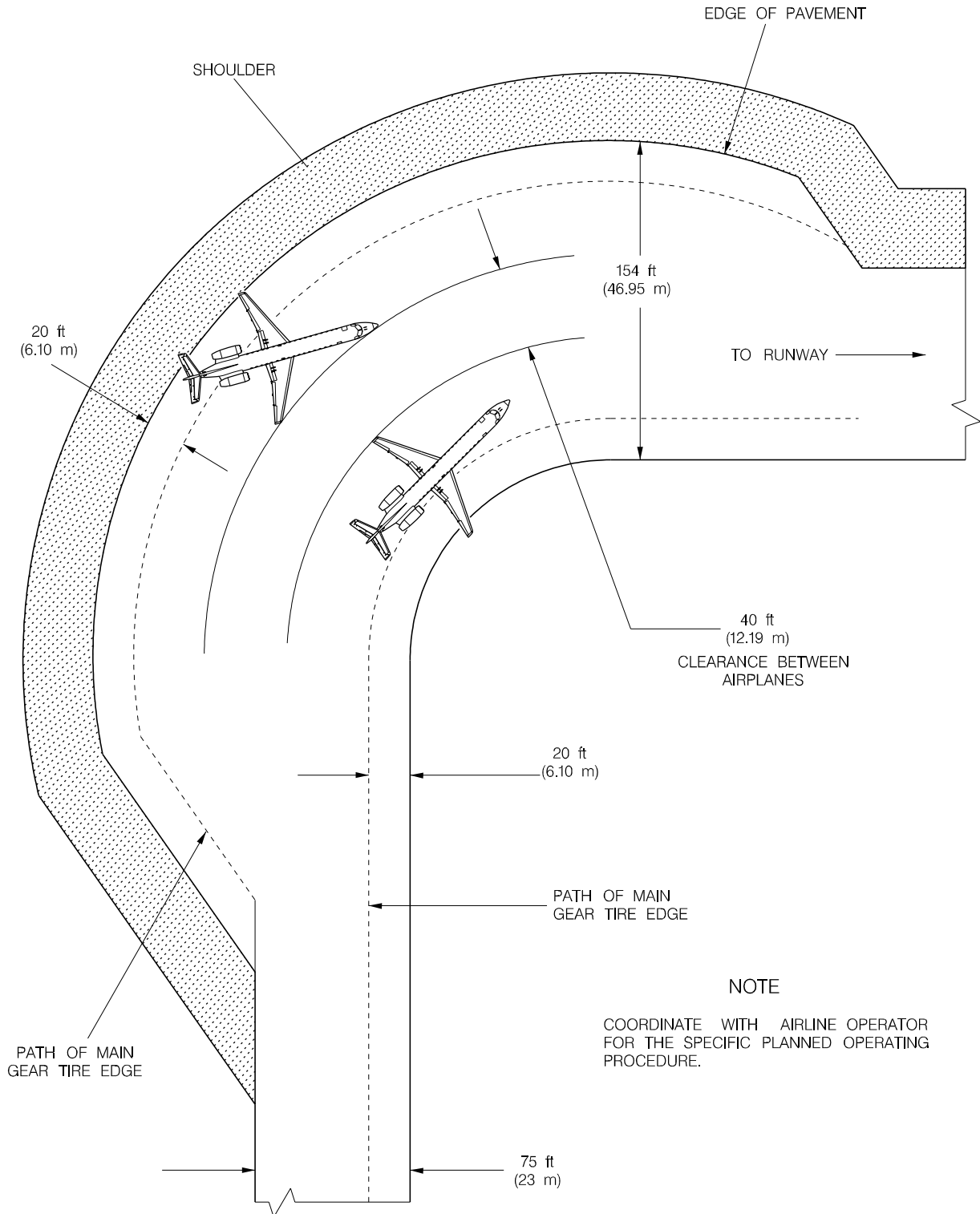


APM040030.MCE A

Figure 4.5.3 - 90° Turn - Taxiway to Taxiway

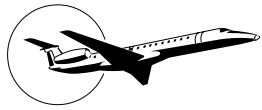


4.6 Runway Holding Bay

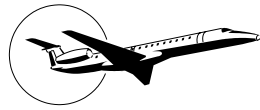


APM040041.MCE A

Figure 4.6.1 - Runway Holding Bay



THIS PAGE LEFT BLANK INTENTIONALLY



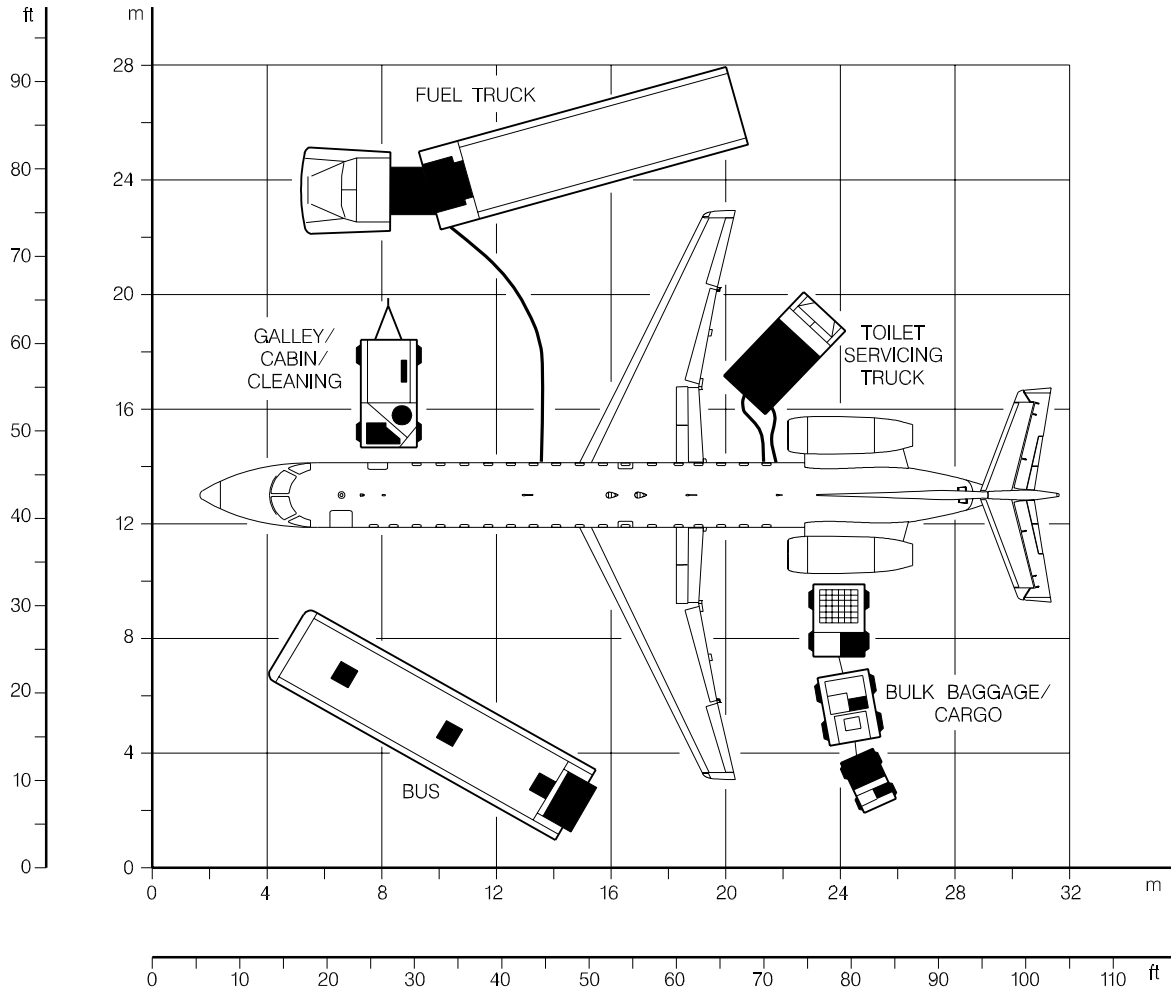
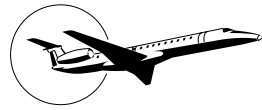
5. TERMINAL SERVICING

5.1 General Information

During turnaround at the air terminal, certain services must be performed on aircraft, usually within a given time to meet flight schedules. This section shows service vehicle arrangements, schedules, locations of servicing points, and typical servicing requirements. The data presented herein reflect ideal conditions for a single airplane. Servicing requirements may vary according to the airplane condition and airline procedure.

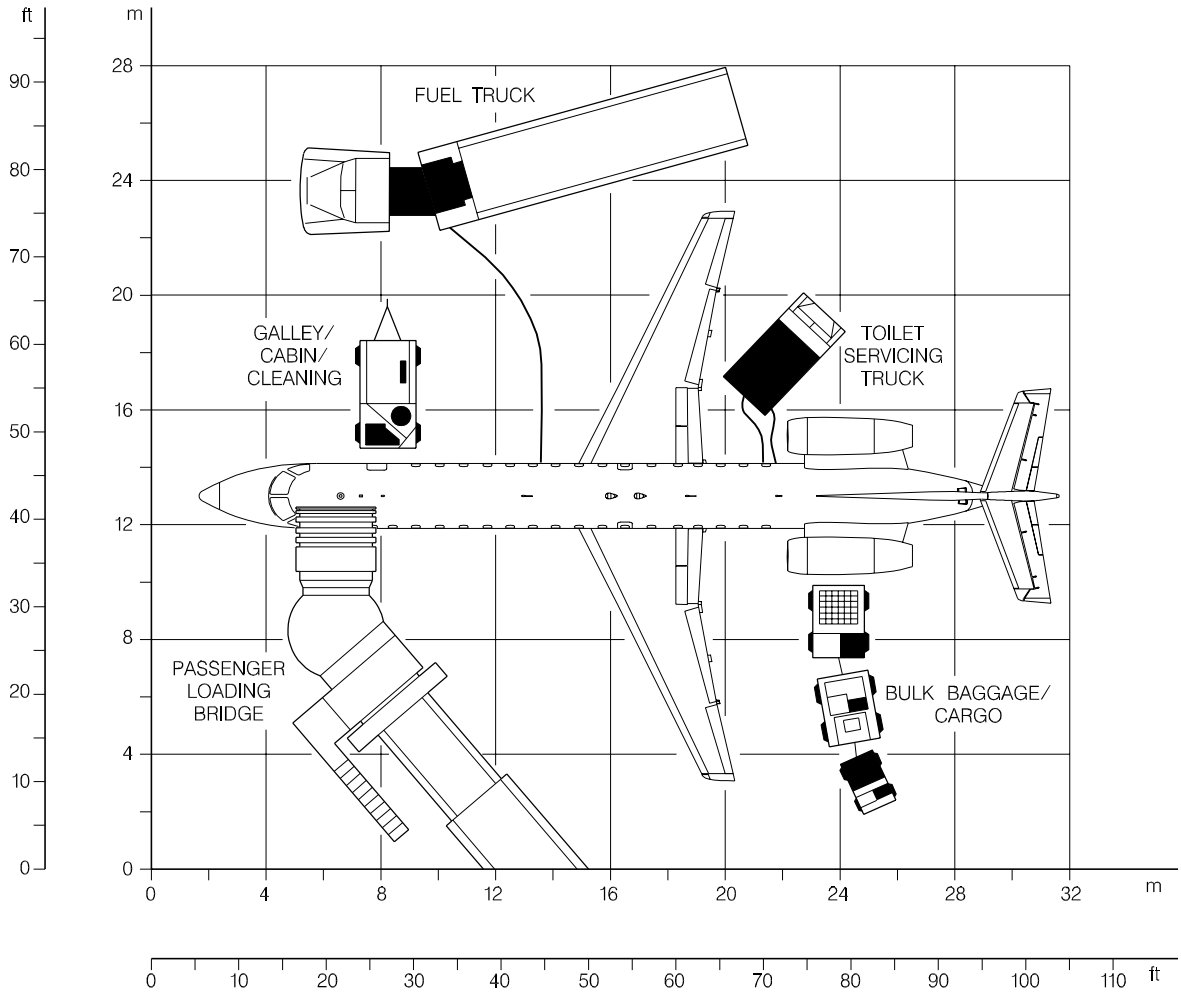
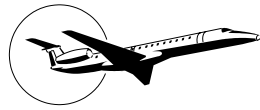
This section provides the following information:

- Typical arrangements of ground support equipment during turnaround.
- Typical turnaround and enroute servicing times at an air terminal. These charts give typical schedules for performing servicing on the airplane within a given time. Servicing times could be rearranged to suit availability of personnel, airplane configuration, and degree of servicing required.
- The locations of ground servicing connections in graphic and tabular forms. Typical capacities and servicing requirements are shown in the figures. Services with requirements that vary with conditions are described in subsequent figures.
- Air conditioning requirements for heating and cooling the airplane, using low-pressure conditioned air. This conditioned air is supplied through an 8-inch GAC directly to the air distribution system, bypassing the air-cycle machines. Normally, a 36000 BTU/h source would be sufficient to meet the air conditioning requirements.
- Ground towing requirements for various towing conditions. Drawbar pull and total traction wheel load may be determined by considering airplane weight, pavement slope, coefficient of friction, and engine idle thrust.



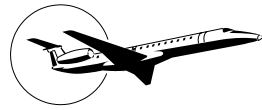
145AP016.MCE

Figure 5.1.1 - EMB-145 Airplane Servicing Arrangement
Sheet 1



145AP060.MCE

*Figure 5.1.1 - EMB-145 Airplane Servicing Arrangement
 Sheet 2*



5.2 Air Terminal Operation - Turnaround Station

		TIME (MINUTES) ↓	5	10	15	20
OPERATIONS		MIN				
COCKPIT CREW DUTIES	SHUTDOWN ENGINES	1	█			
	CLEAR AIRPLANE FOR DEPARTURE	2			█	
PASSENGER SERVICE	DEPLANE PASSENGERS	4	█			
	SERVICE AIRPLANE INTERIOR	6		█		
	SERVICE GALLEY	7	█			
	SERVICE POTABLE WATER	5	█			
	ENPLANE PASSENGERS	5			█	
BAGGAGE AND CARGO	UNLOAD BAGGAGE/CARGO	6	█			
	LOAD BAGGAGE/CARGO	8		█		
OTHER SERVICE	FUEL AIRPLANE [1]	10	█			
	FUEL AIRPLANE [2]	12	█			
	FUEL AIRPLANE [3]	14	█			
	SERVICE TOILET	7	█			

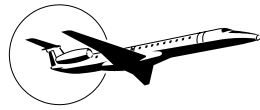
- [1] APPLICABLE TO EMB-145 ER/EU/EP/MR/MP
- [2] APPLICABLE TO EMB-145 LR/LU
- [3] APPLICABLE TO EMB-145 XR

NOTE:

- TIME OF 18 MINUTES INCLUDES EQUIPMENT POSITIONING AND REMOVAL
- 85% FUEL TANK CAPACITY REFUELING PRESSURE 50 psi (344 kPa) at 125 gpm (473 lpm)

145APM000001.MCE C

Figure 5.2.1 - Air Terminal Operation - Turnaround Station



5.3 Air Terminal Operation - Enroute Station

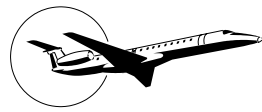
		TIME (MINUTES) ↓	5	10	15	20	25
OPERATIONS		MIN					
COCKPIT CREW DUTIES	SHUTDOWN ENGINES	1	█				
	CLEAR AIRPLANE FOR DEPARTURE	2		█			
PASSENGER SERVICE	DEPLANE PASSENGERS	3	█				
	SERVICE AIRPLANE INTERIOR	3		█			
	SERVICE GALLEY	4.5	█				
	SERVICE POTABLE WATER	5	█				
	ENPLANE PASSENGERS	3		█			
BAGGAGE AND CARGO	UNLOAD BAGGAGE/CARGO	4	█				
	LOAD BAGGAGE/CARGO	5.5		█			
OTHER SERVICE	SERVICE TOILET	6	█				

NOTE:

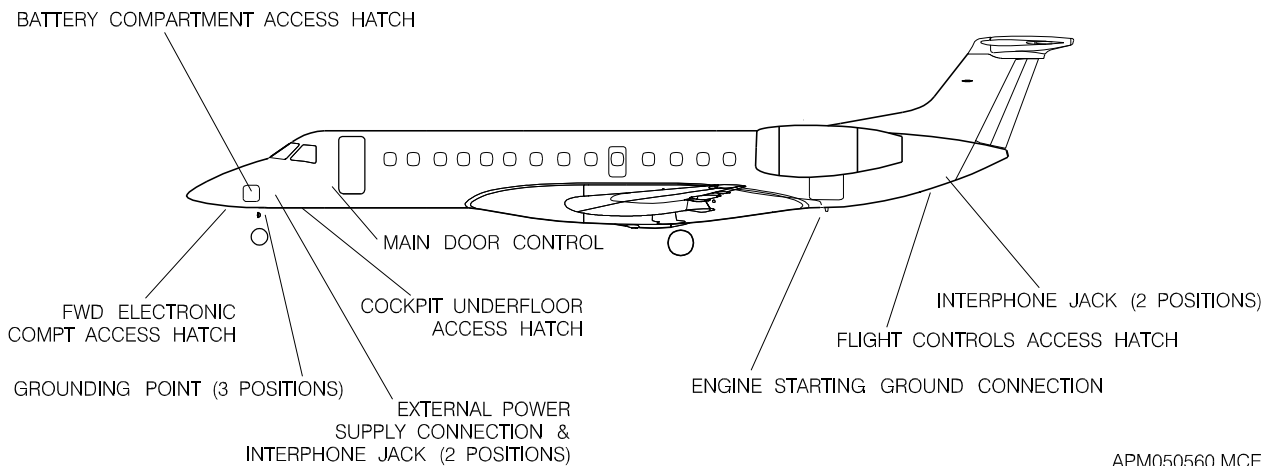
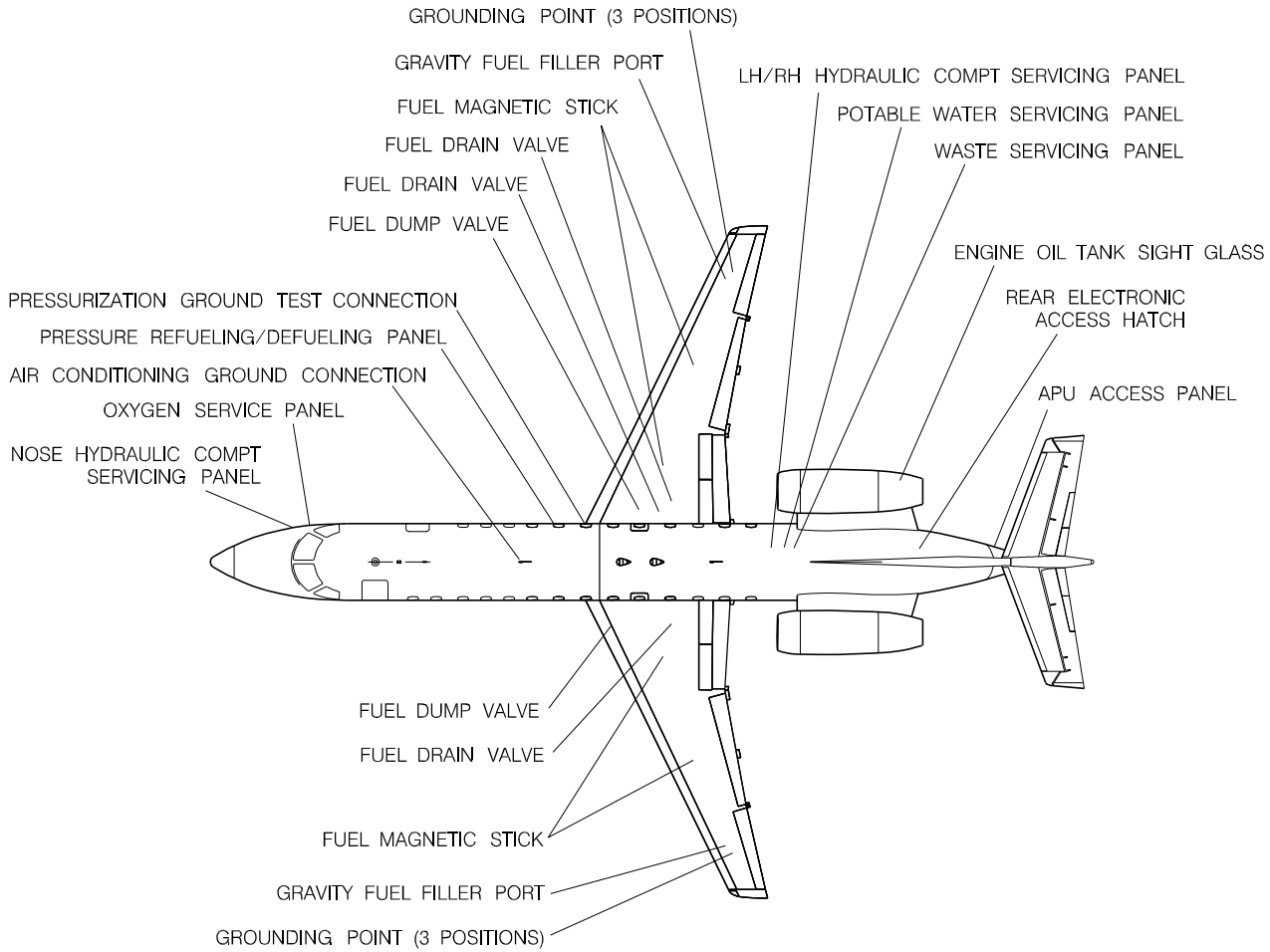
- TIME OF 12 MINUTES INCLUDES EQUIPMENT POSITIONING AND REMOVAL

145APM000002.MCE A

Figure 5.3.1 - Air Terminal Operation - Enroute Station



5.4 Ground Servicing Connections EMB-145



APM050560.MCE

Figure 5.4.1 - Ground Servicing Connections EMB-145 ER / MP

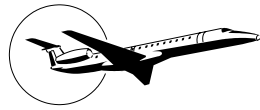
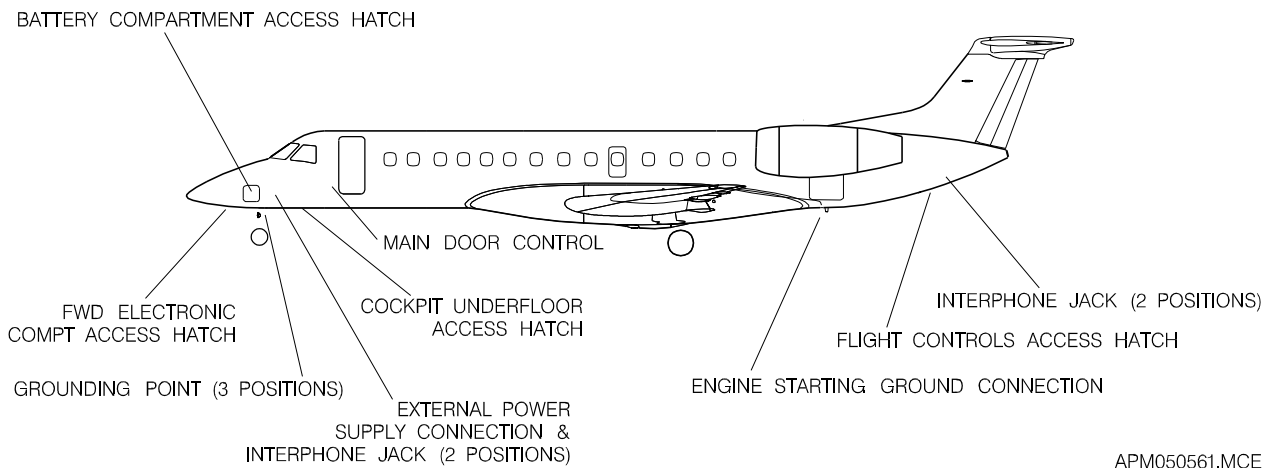
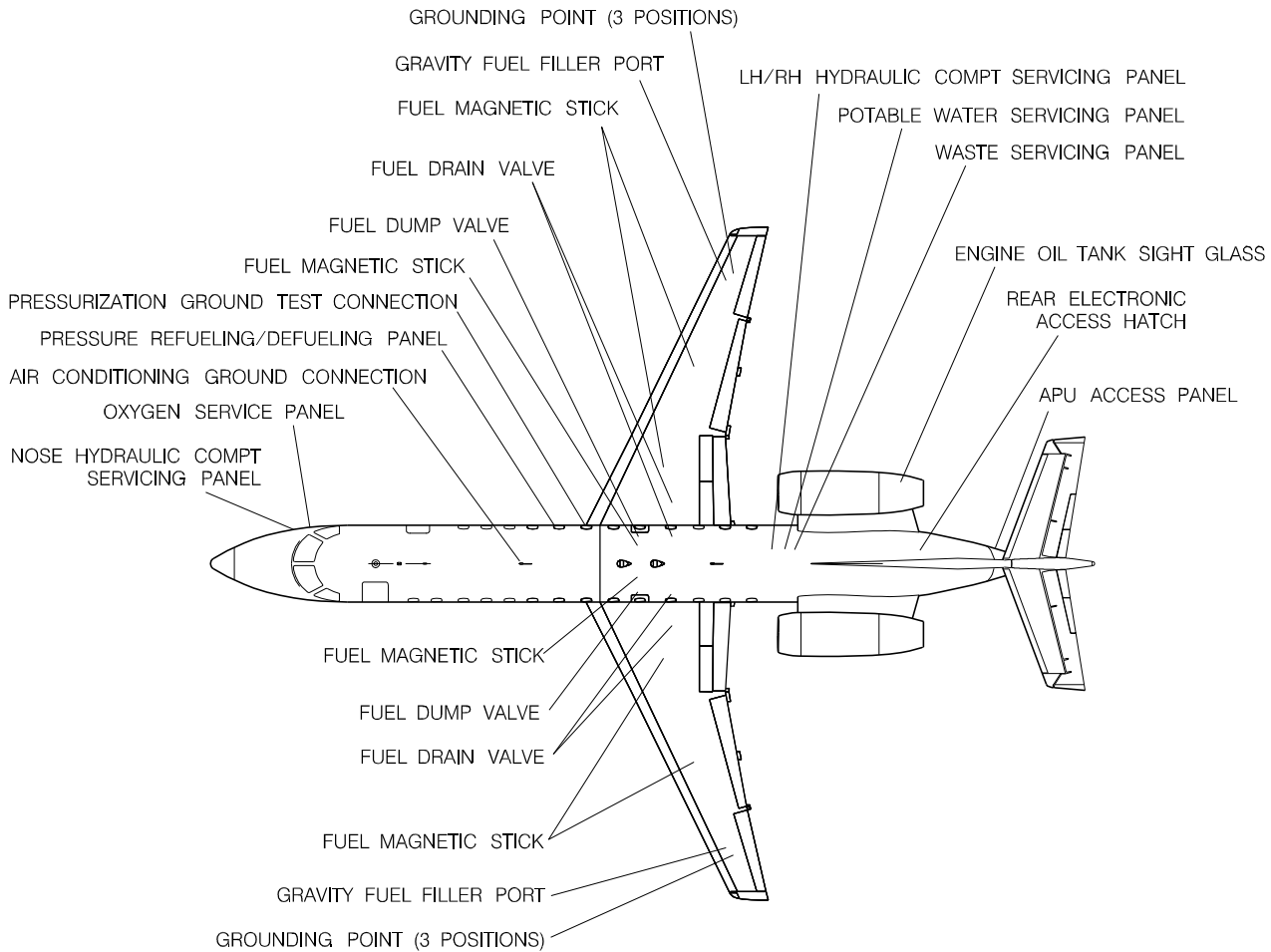
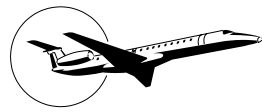


Table 5.4.1 - Ground Servicing Connections EMB-145 ER / MP

SYSTEM	DISTANCE AFT OF NOSE		DISTANCE FROM AIRPLANE CENTERLINE				HEIGHT ABOVE GROUND	
			RIGHT SIDE		LEFT SIDE		MAXIMUM	
	ft-in	m	ft-in	m	ft-in	m	ft-in	m
1. Hydraulic Power System Three Servicing Connections:								
A. Nose Servicing Panel	6-3	1.90	2-8	0.81	-	-	5-7	1.69
B. LH and RH Servicing Panels	63-3	19.27	1-9	0.53	1-9	0.53	5-4	1.63
2. Electrical Power System One External Power Supply Connection 28 V DC - 1600 A	7-5	2.26	-	-	3-1	0.94	5-7	1.71
3. Oxygen System One Servicing Panel	12-11	3-93	2-8	0.81	-	-	5-1	1.54
4. Fuel System								
A. Gravity Fuel Filler Port	52-6	16.00	17-10	5.43	17-10	5.43	6-1	1.84
B. Fuel Magnetic Stick	49-8	15.15	8-11	2.73	8-11	2.73	4-3	1.31
C. Fuel Magnetic Stick	52-5	15.99	16-4	4.98	16-4	4.98	5-6	1.57
D. Fuel Drain Valve	48-11	14.91	3-6	1.06	3-6	1.06	4-6	1.37
E. Fuel Dump Valve	48-1	14.66	5-1	1.55	5-1	1.55	3-8	1.12
F. Pressure Refueling/Defueling Panel	38-1	11.62	2-10	0.86	-	-	4-11	1.51
5. Air Conditioning System								
One Pressurization Ground Test Connection	40-3	12.26	2-5	0.73	-	-	5-2	1.57
One Air Conditioning Ground Connection	35-8	10.88	1-6	0.46			5-3	1.60
6. Potable Water System One Servicing Panel	66-0	20.12	0-2	0.10	-	-	5-12	1.82
7. Lavatory System Waste Servicing Panel	68-0	20.74	1-6	0.45	-	-	5-3	1.61
8. Powerplant Two Engine Oil Supply/Level Check Panels:								
A. LH Panel	74-7	22.73	-	-	6-1	1.84	10-1	3.06
B. RH Panel	74-7	22.73	7-8	2.35	-	-	10-1	3.06
Ground Connection for Engine Air Starting	76-11	23.46	0-11	0.27	-	-	5-2	1.57



APM050561.MCE

Figure 5.4.2 - Ground Servicing Connections EMB-145 LR

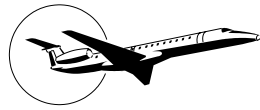
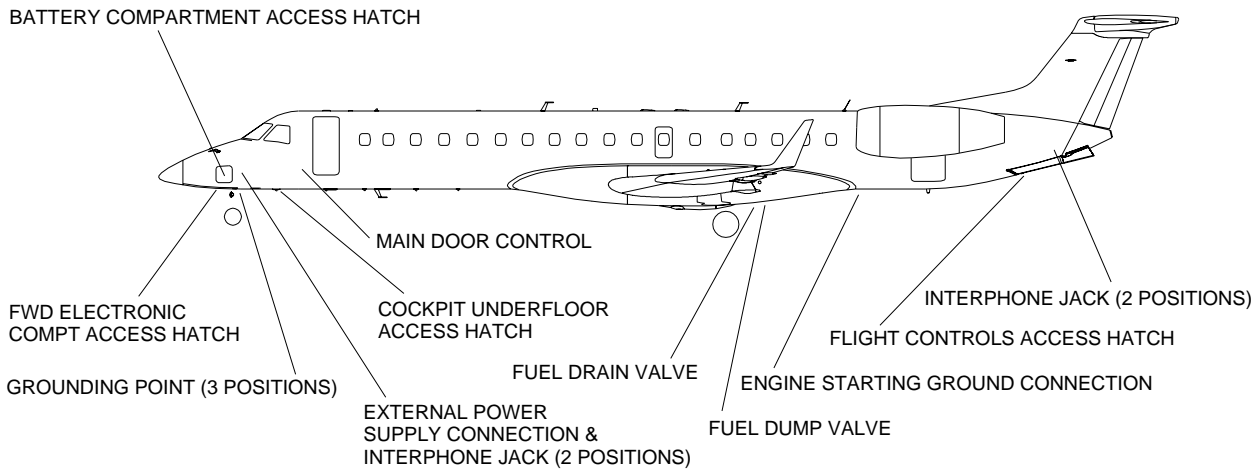
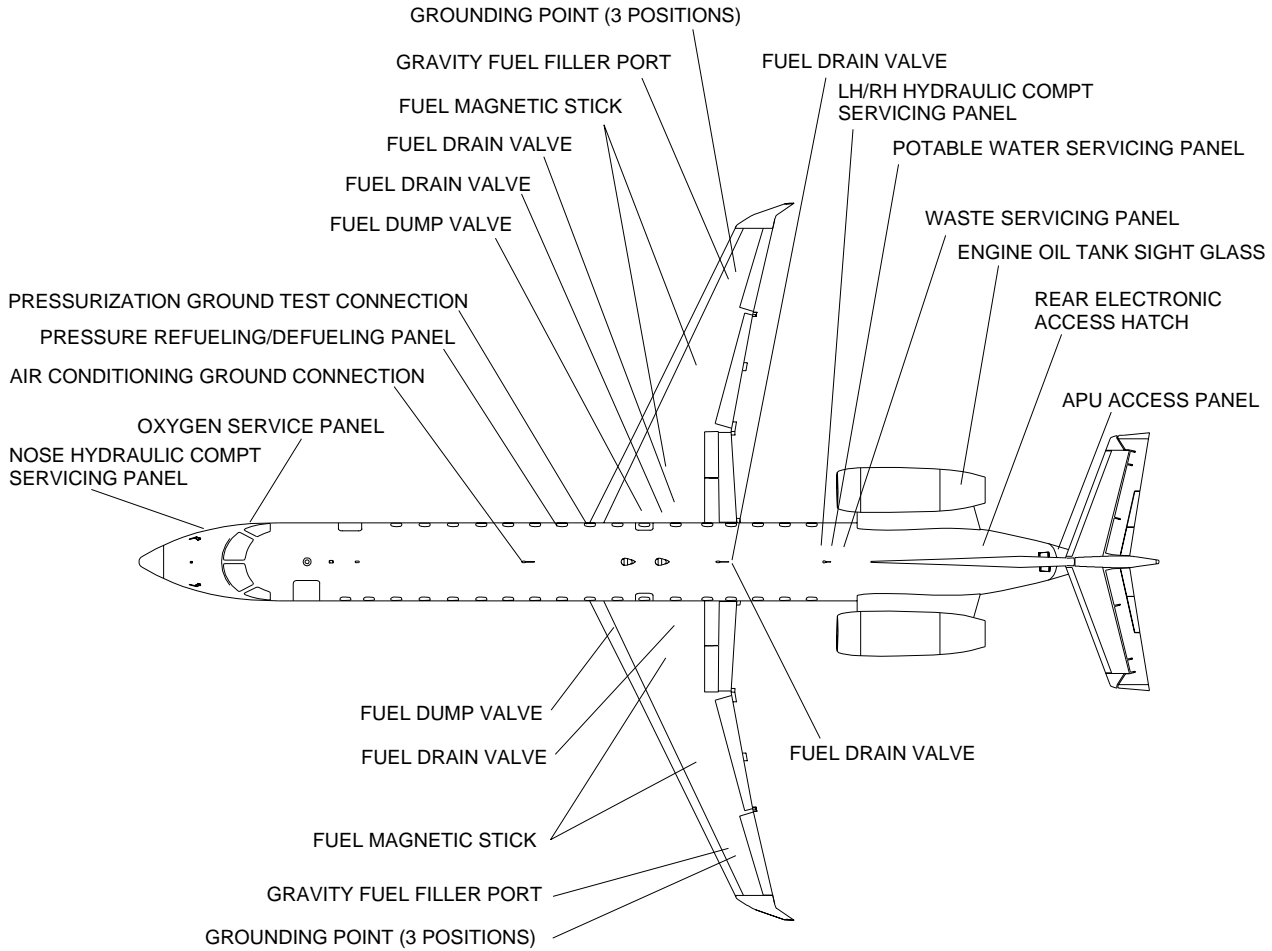
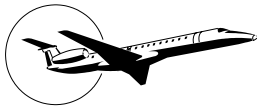


Table 5.4.2 - Ground Servicing Connections EMB-145 LR

SYSTEM	DISTANCE AFT OF NOSE		DISTANCE FROM AIRPLANE CENTERLINE				HEIGHT ABOVE GROUND	
			RIGHT SIDE		LEFT SIDE		MAXIMUM	
	ft-in	m	ft-in	m	ft-in	m	ft-in	m
1. Hydraulic Power System Three Servicing Connections:								
A. Nose Servicing Panel	6-3	1.90	2-8	0.81	-	-	5-7	1.69
B. LH and RH Servicing Panels	63-3	19.27	1-9	0.53	1-9	0.53	5-4	1.63
2. Electrical Power System One External Power Supply Connection 28 V DC - 1600 A	7-5	2.26	-	-	3-1	0.94	5-7	1.71
3. Oxygen System One Servicing Panel	12-11	3-93	2-8	0.81	-	-	5-1	1.54
4. Fuel System								
A. Gravity Fuel Filler Port	52-6	16.00	17-10	5.43	17-10	5.43	6-1	1.84
B. Fuel Magnetic Stick	49-8	15.15	8-11	2.73	8-11	2.73	4-3	1.31
C. Fuel Magnetic Stick	52-5	15.99	16-4	4.98	16-4	4.98	5-6	1.57
D. Fuel Magnetic Stick	47-4	14.44	1-1	0.35	1-1	0.35	3-6	1.06
E. Fuel Drain Valve	48-11	14.91	3-6	1.06	3-6	1.06	4-6	1.37
F. Fuel Drain Valve	49-2	14.98	1-4	0.41	1-4	0.41	3-6	1.06
G. Fuel Dump Valve	47-4	14.44	2-2	0.68	2-2	0.68	3-6	1.06
H. Pressure Refueling/Defueling Panel	38-1	11.62	2-10	0.86	-	-	4-11	1.51
5. Air Conditioning System								
One Pressurization Ground Test Connection	40-3	12.26	2-5	0.73	-	-	5-2	1.57
One Air Conditioning Ground Connection	35-8	10.88	1-6	0.46			5-3	1.60
6. Potable Water System One Servicing Panel	66-0	20.12	0-2	0.10	-	-	5-12	1.82
7. Lavatory System Waste Servicing Panel	68-0	20.74	1-6	0.45	-	-	5-3	1.61
8. Powerplant								
Two Engine Oil Supply/Level Check Panels:								
A. LH Panel	74-7	22.73	-	-	6-1	1.84	10-1	3.06
B. RH Panel	74-7	22.73	7-8	2.35	-	-	10-1	3.06
Ground Connection for Engine Air Starting	76-11	23.46	0-11	0.27	-	-	5-2	1.57



145APM050564.MCE

Figure 5.4.3 - Ground Servicing Connections EMB-145 XR

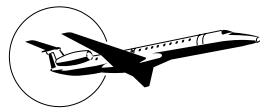
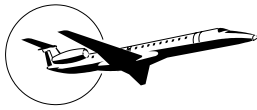


Table 5.4.3 - Ground Servicing Connections EMB-145 XR

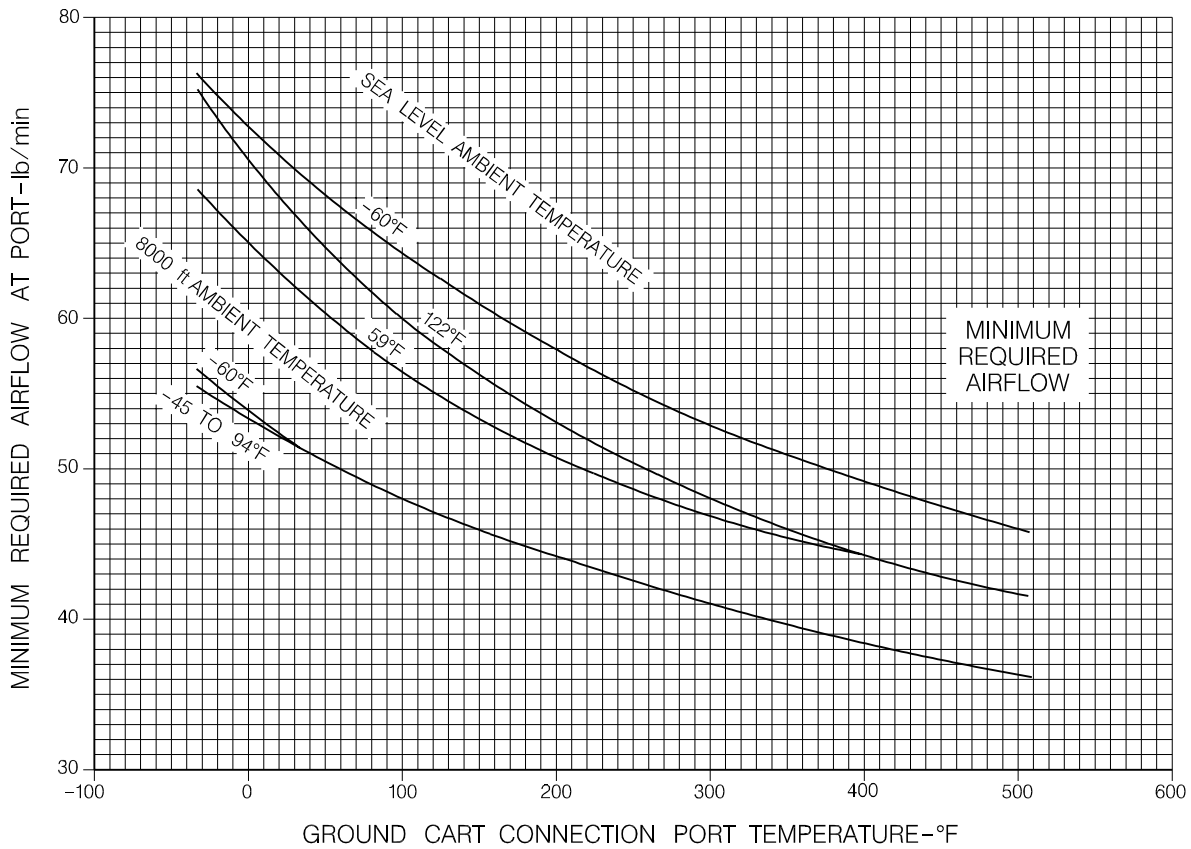
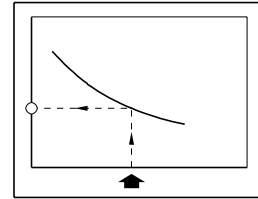
SYSTEM	DISTANCE AFT OF NOSE		DISTANCE FROM AIRPLANE CENTERLINE				HEIGHT ABOVE GROUND	
			RIGHT SIDE		LEFT SIDE		MAXIMUM	
	ft-in	m	ft-in	m	ft-in	m	ft-in	m
1. Hydraulic Power System Three Servicing Connections:								
A. Nose Servicing Panel	6-3	1.90	2-8	0.81	-	-	5-7	1.69
B. LH and RH Servicing Panels	63-3	19.27	1-9	0.53	1-9	0.53	5-4	1.63
2. Electrical Power System One External Power Supply Connection 28 V DC - 1600 A	7-5	2.26	-	-	3-1	0.94	5-7	1.71
3. Oxygen System One Servicing Panel	12-11	3-93	2-8	0.81	-	-	5-1	1.54
4. Fuel System								
A. Gravity Fuel Filler Port	52-6	16.00	17-10	5.43	17-10	5.43	6-2	1.88
B. Fuel Magnetic Stick	49-10	15.20	8-9	2.67	8-9	2.67	5-9	1.77
C. Fuel Magnetic Stick	52-6	16.00	16-4	4.98	16-4	4.98	5-6	1.88
D. Fuel Drain Valve	49-2	15.00	3-6	1.07	3-6	1.07	4-6	1.13
E. Fuel Drain Valve	56-10	17.33	0-2	0.06	0-2	0.06	3-5	1.05
F. Fuel Dump Valve	48-2	14.70	5-1	1.55	5-1	1.55	3-11	1.21
G. Fuel Dump Valve	57-8	17.58	-	-	-	-	3-6	1.07
H. Pressure Refueling/Defueling Panel	38-0	11.59	3-4	1.02	-	-	4-7	1.42
5. Air Conditioning System								
One Pressurization Ground Test Connection	40-3	12.26	2-5	0.73	-	-	5-2	1.57
One Air Conditioning Ground Connection	35-8	10.88	1-6	0.46			5-3	1.60
6. Potable Water System One Servicing Panel	66-0	20.12	0-2	0.05	-	-	5-12	1.82
7. Lavatory System Waste Servicing Panel	68-0	20.74	1-6	0.45	-	-	5-3	1.61
8. Powerplant Two Engine Oil Supply/Level Check Panels:								
A. LH Panel	74-1	22.59	-	-	5-10	1.79	9-1	2.76
B. RH Panel	74-1	22.59	8-2	2.49	-	-	9-5	2.82
Ground Connection for Engine Air Starting	76-11	23.46	0-11	0.27	-	-	5-7	1.70



5.5 Engine Starting Pneumatic Requirements

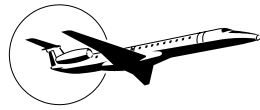
**EMB-145/EMB-135 PNEUMATIC STARTING SYSTEM
GROUND CART MINIMUM REQUIREMENTS**

AE3007A SERIES ENGINES



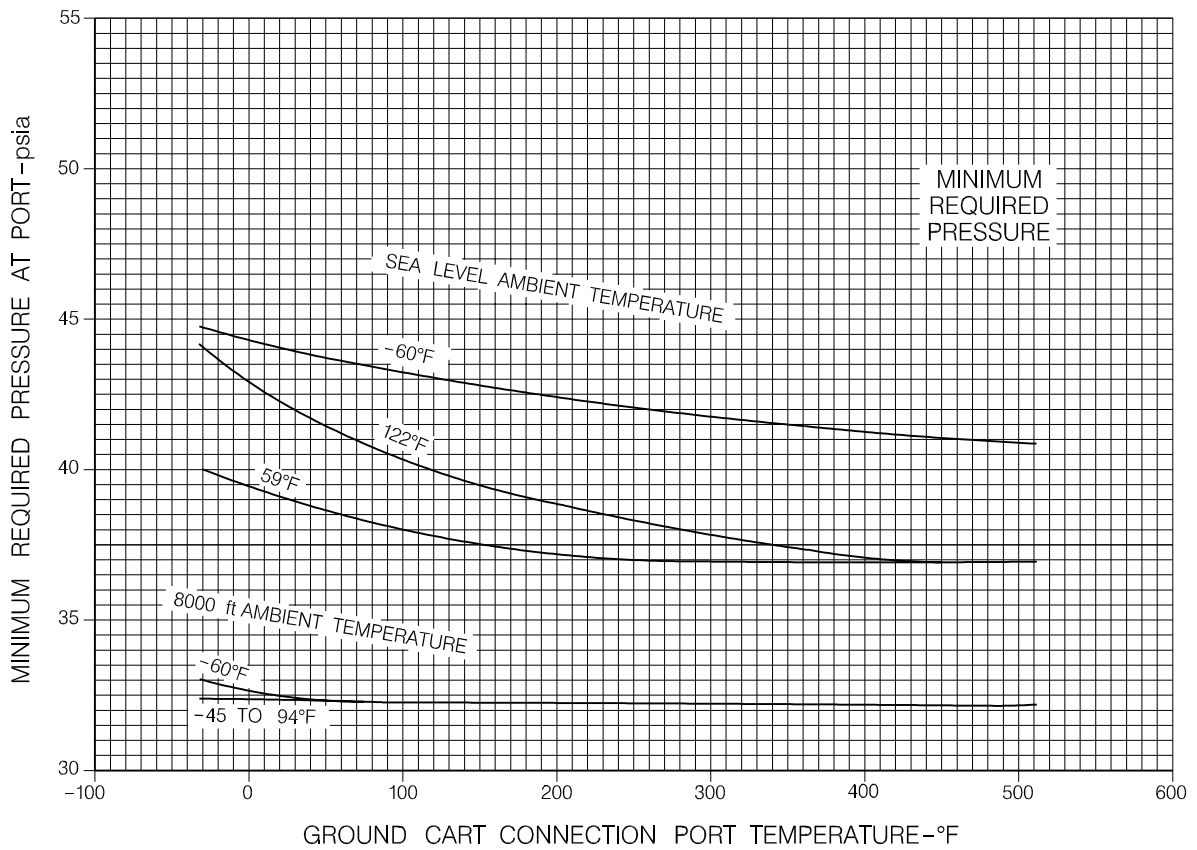
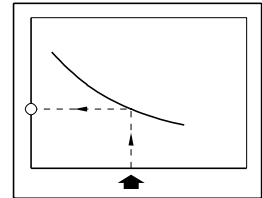
APM050024.MCE C

Figure 5.5.1 - Engine Starting Pneumatic Requirements - Airflow x Temperature



EMB-145/EMB-135 PNEUMATIC STARTING SYSTEM
GROUND CART MINIMUM REQUIREMENTS

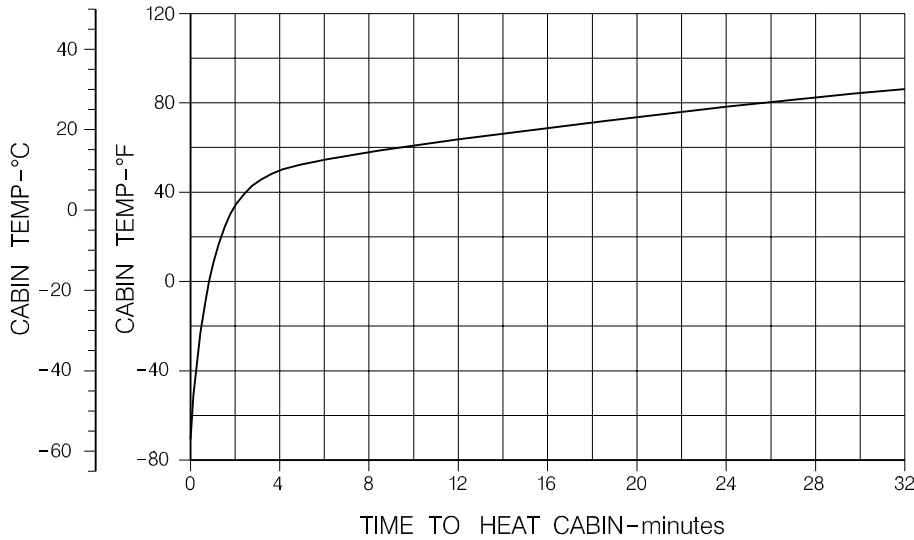
AE3007A SERIES ENGINES



APM050025.MCE C

Figure 5.5.2 - Engine Starting Pneumatic Requirements - Pressure x Temperature

5.6 Ground Pneumatic Power Requirements

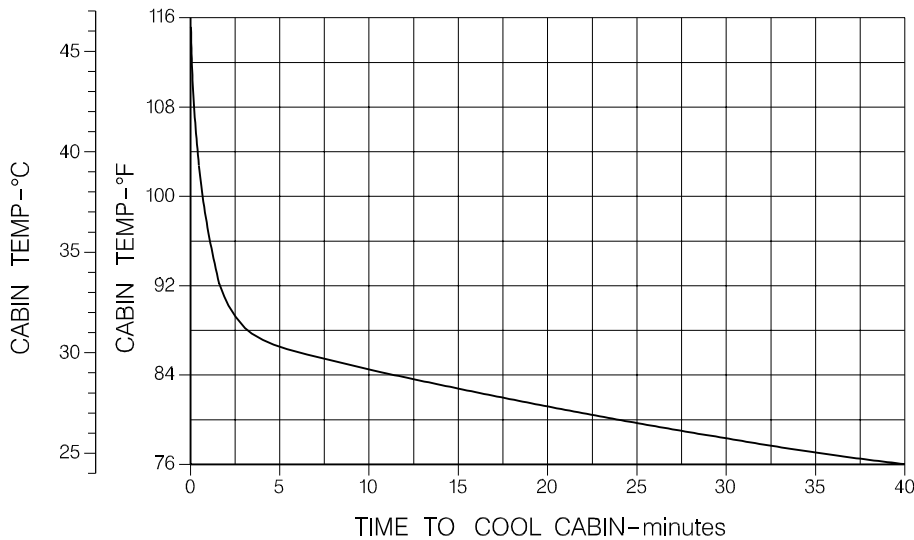


HEATING

Initial cabin temp: -65°F (-54°C)
 Outside air temp: -65°F (-54°C)
 Relative Humidity: 0%
 No crew or passengers
 No other heat load

Bleed air from APU:
 34.5 kg/min, (76 lb/min)
 420 kPa (61 psia)
 2 operating packs (ECS)

Cabin airflow:
 ~ 43 kg/min (95 lb/min)
 temp ~ 160°F (71°C)



COOLING

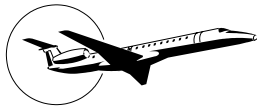
Initial cabin temp: 116°F (47°C)
 Outside air temp: 104°F (40°C)
 Relative Humidity: 40%
 No crew or passengers
 No other heat load

Bleed air from APU:
 25 kg/min, (55 lb/min)
 338 kPa (49 psia)
 2 operating packs (ECS)

Cabin airflow:
 ~ 25 kg/min (55 lb/min)
 temp ~ 32°F (0°C)

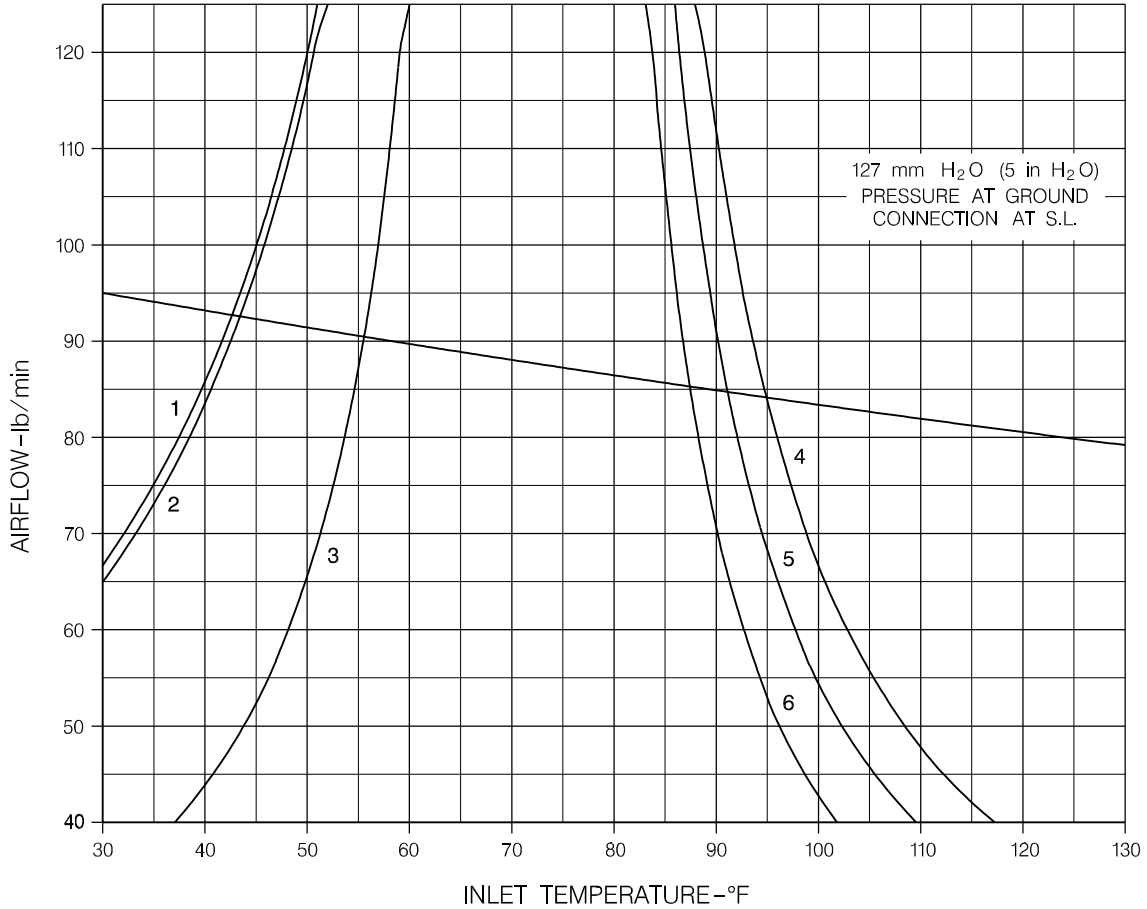
145AP026.MCE A

Figure 5.6.1 - Ground Pneumatic Power Requirements (APU Mode)



5.7 Conditioned Air Requirements

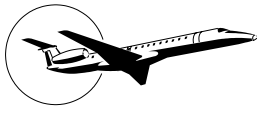
PRE-CONDITIONED AIRFLOW REQUIREMENTS



CONDITIONS	AMBIENT TEMP		SOLAR LOAD (BTU/h)	ELECTRICAL LOAD (BTU/h)	OCCUPANTS	CABIN TEMP	
	(°C)	(°F)				(°C)	(°F)
1	39	103	14400	10600	54	24	75
2	39	103	14400	10600	54	27	80
3	39	103	0	10600	4	21	70
4	-40	-40	0	0	4	24	75
5	-29	-20	0	0	4	24	75
6	-18	0	0	0	4	24	75

APM050551.MCE

Figure 5.7.1 - Pre-conditioned Airflow Requirements



5.8 Ground Towing Requirements

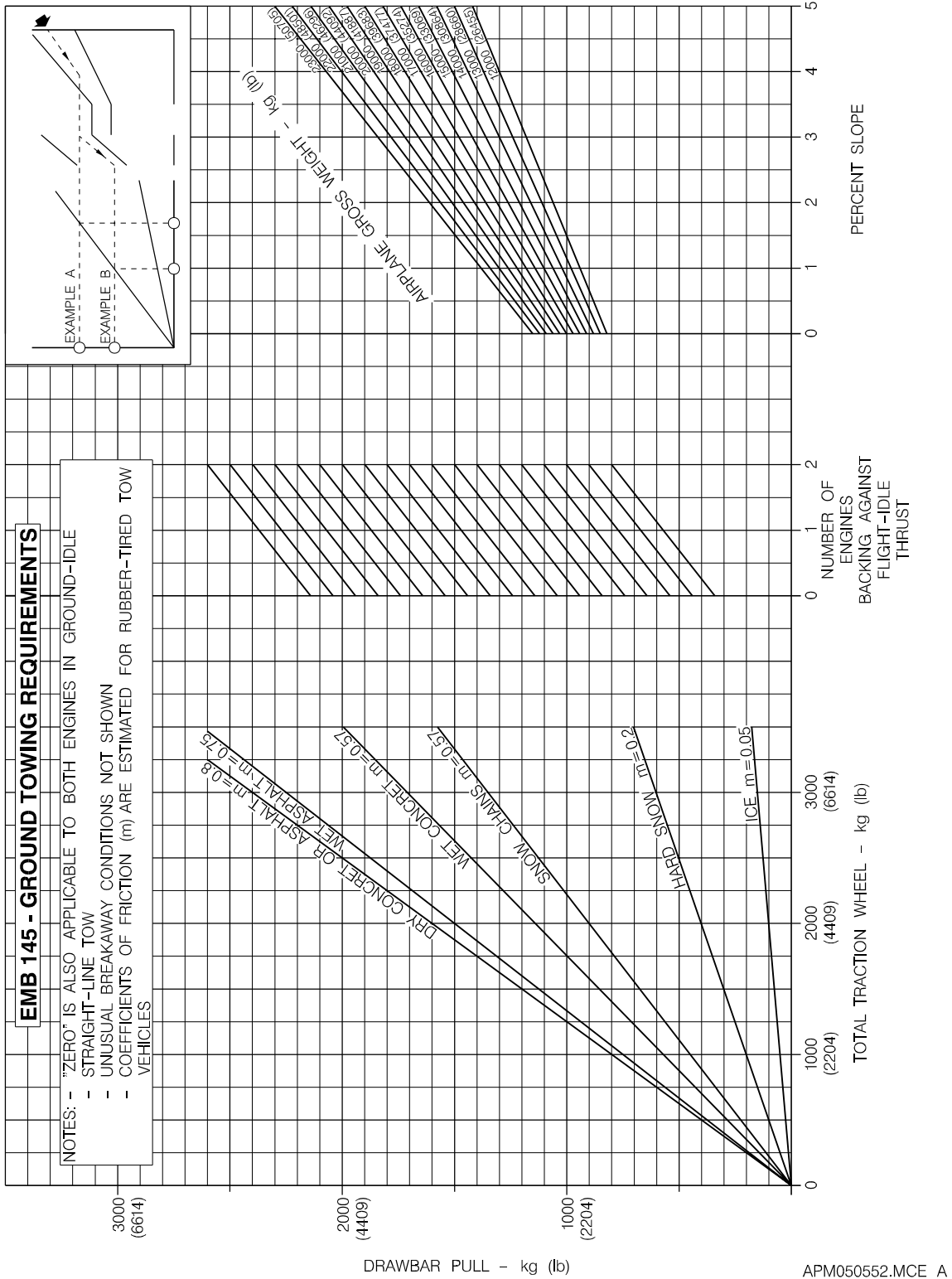
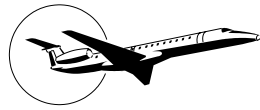


Figure 5.8.1 - Ground Towing Requirements

APM050552.MCE A



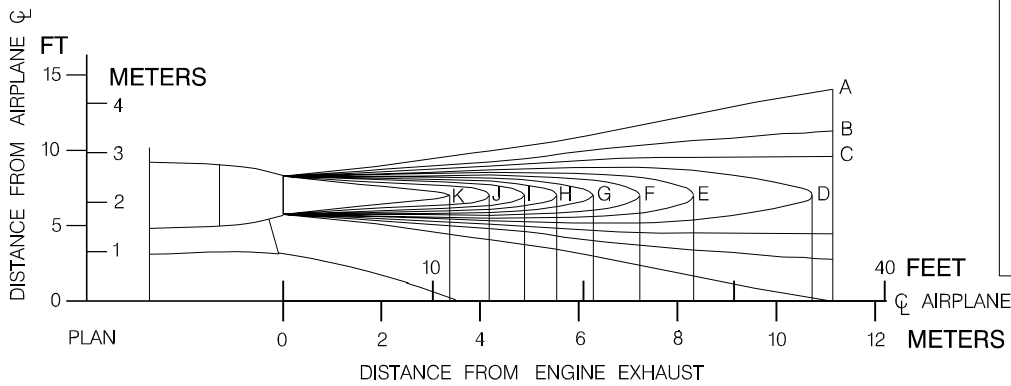
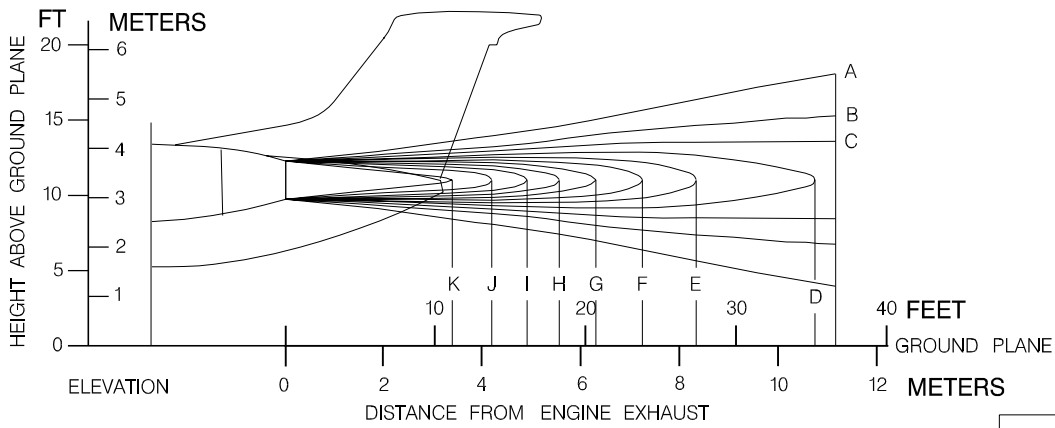
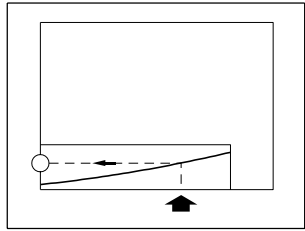
6. OPERATING CONDITIONS

This section presents graphics concerning:

- The EMB-145 aircraft Jet Engine Exhaust velocities and temperatures,
- The Airport and Community Noise levels and Hazard Areas.

6.1 Engine Exhaust Velocities and Temperatures

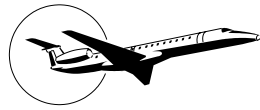
TO-1 THRUST MODE, STATIC, SEA LEVEL
ISA + 15°C



VELOCITY (ft/s)	
MAX	978
MIN	0.0
A	10
B	100
C	200
D	300
E	400
F	500
G	600
H	700
I	800
J	900
K	970

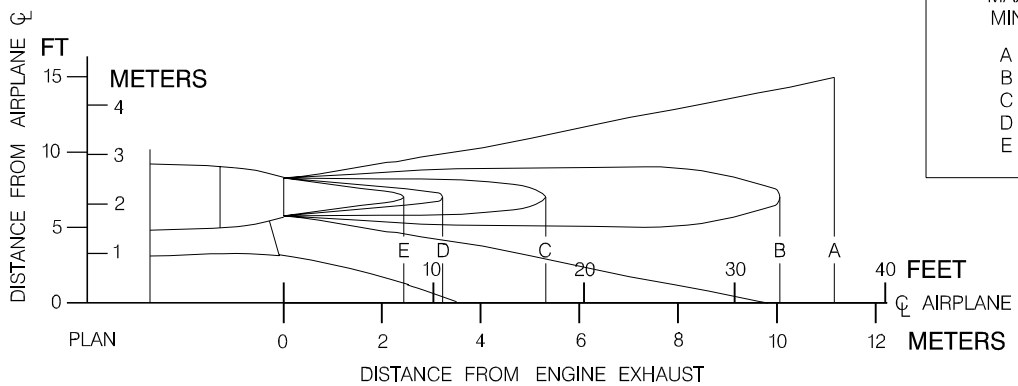
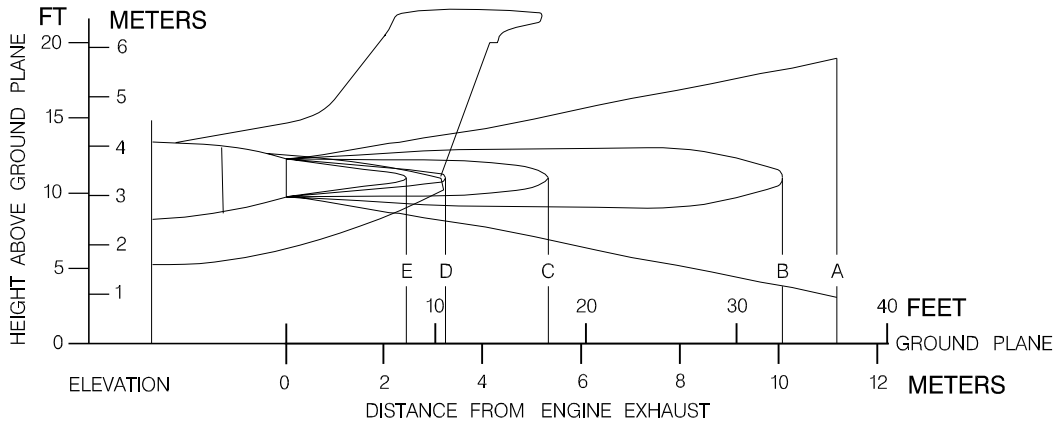
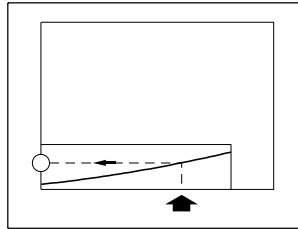
APM060018.MCE B

Figure 6.1.1 - Jet Wake Velocity Profile (T/O-1 Thrust Mode)



TO-1 THRUST MODE, STATIC, SEA LEVEL

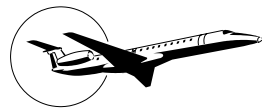
ISA + 15°C



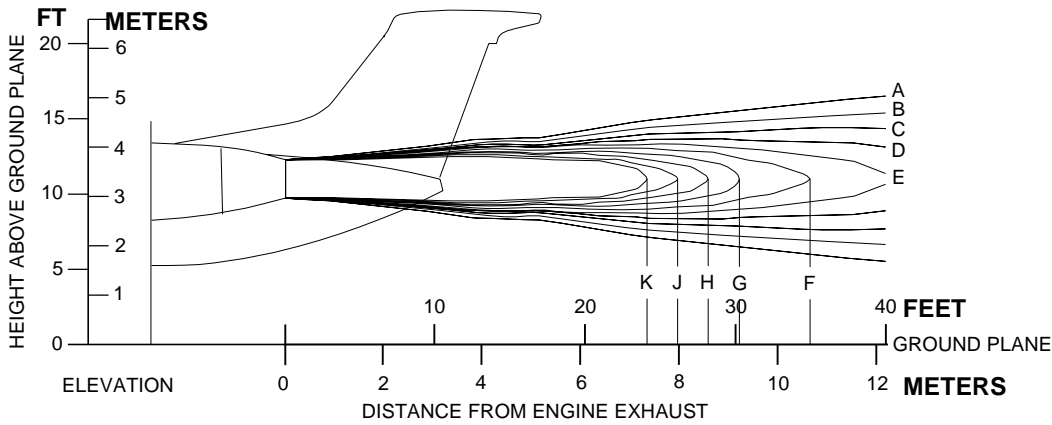
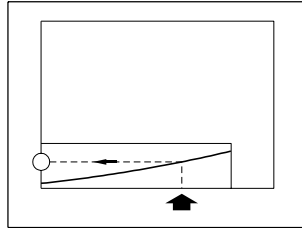
TEMPERATURE (°F) (°C)		
MAX	252	122
MIN	86	30
A	90	32
B	140	60
C	190	88
D	240	116
E	250	121

APM060019.MCE B

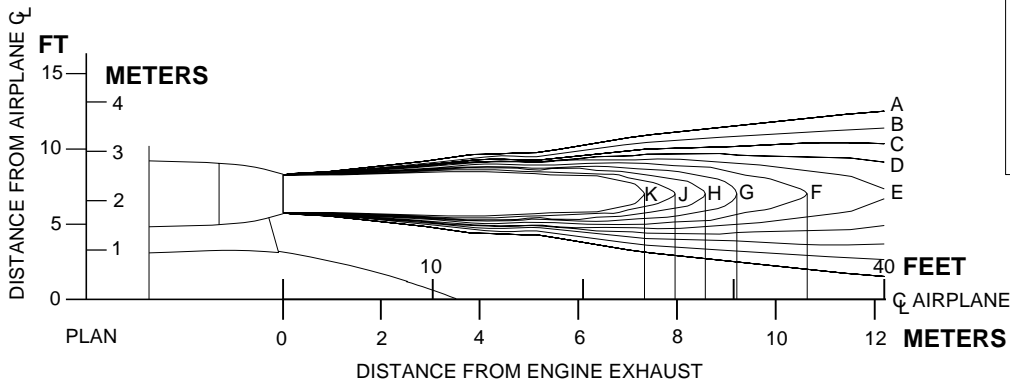
Figure 6.1.2 - Jet Wake Temperature Profile (T/O-1 Thrust Mode)



BREAKAWAY, STATIC, SEA LEVEL
ISA+15°C

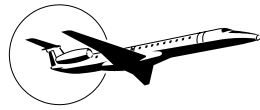


LEVEL	VELOCITY (ft/s)
A	50
B	75
C	100
D	125
E	150
F	175
G	200
H	225
J	250
K	274

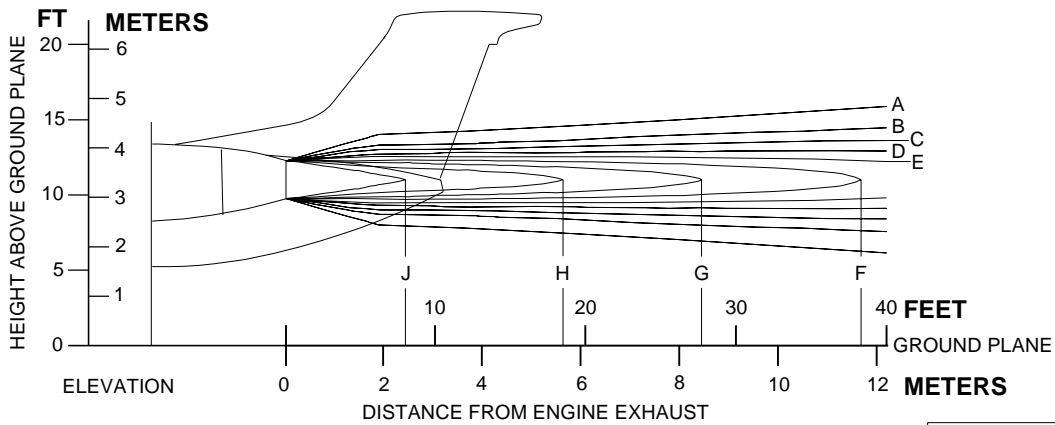
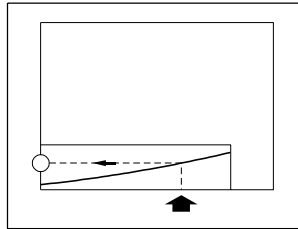


EM145APM060001B.DGN

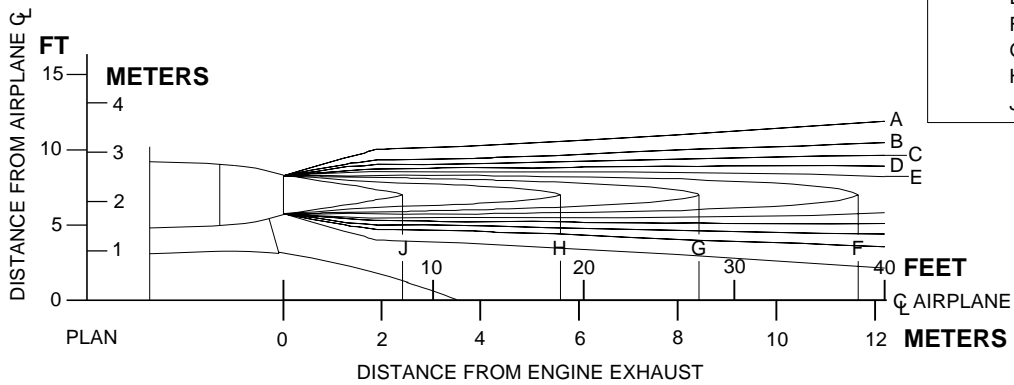
Figure 6.1.3 - Jet Wake Velocity Profile (Breakaway)



BREAKAWAY, STATIC, SEA LEVEL
ISA+15°C



TEMPERATURE	(°C)	(°F)
A	16	60
B	21	70
C	27	80
D	32	90
E	38	100
F	43	110
G	49	120
H	54	130
J	60	140

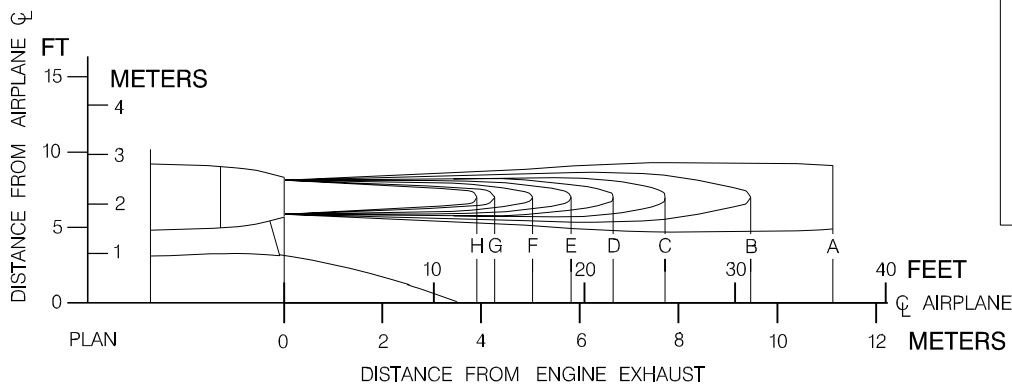
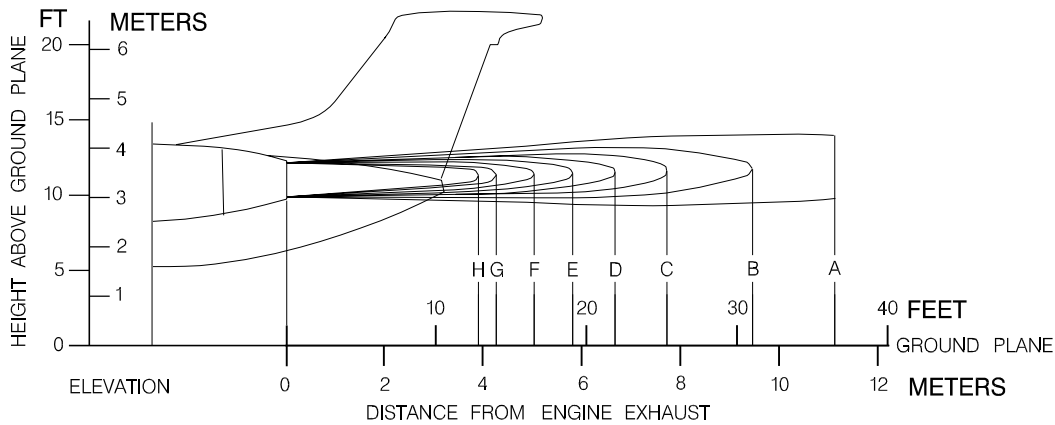
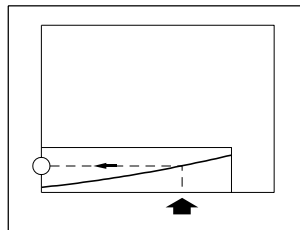


EM145APM060002B.DGN

Figure 6.1.4 - Jet Wake Temperature Profile (Breakaway)



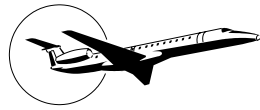
IDLE THRUST MODE, STATIC, SEA LEVEL
ISA + 15°C



VELOCITY (ft/sec)	
MAX	220
MIN	0.0
A	50
B	75
C	100
D	125
E	150
F	175
G	200
H	210

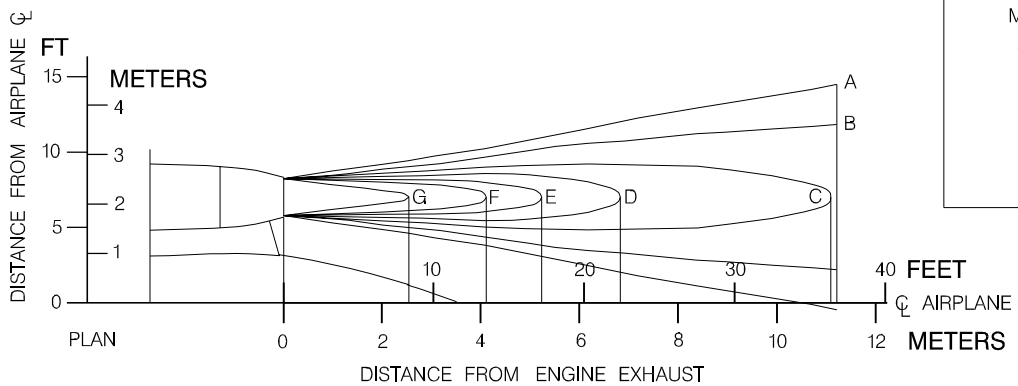
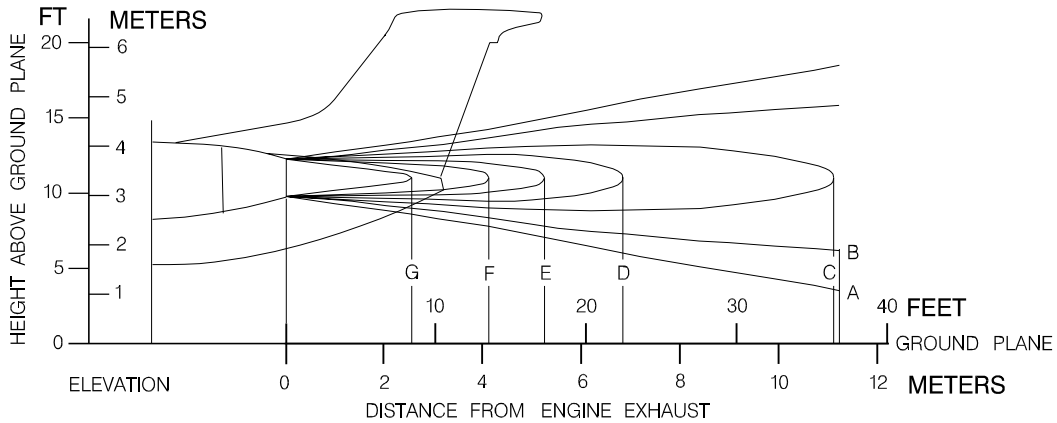
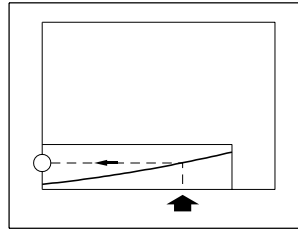
APM060020.MCE B

Figure 6.1.5 - Jet Wake Velocity Profile (Idle Thrust Mode)



IDLE THRUST MODE, STATIC, SEA LEVEL

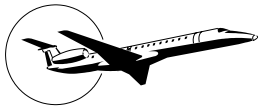
ISA +15°C



TEMPERATURE (°F) (°C)		
MAX	201	94
MIN	86	30
A	90	32
B	100	38
C	120	49
D	140	60
E	160	71
F	180	82
G	200	93.5

APM060021.MCE B

Figure 6.1.6 - Jet Wake Temperature Profile (Idle Thrust Mode)



6.2 Airport and Community Noise

Aircraft noise is a major concern for the airport and community planner. The airport is a basic element in the community's transportation system and, as such, is vital to its growth. However, the airport must also be a good neighbor, and this can be accomplished only with proper planning. Since aircraft noise extends beyond the boundaries of the airport, it is vital to consider the noise impact on the surrounding communities.

Many means have been devised to provide the planner with a tool to estimate the impact of airport operations. Too often they oversimplify noise to the point where the results become erroneous. Noise is not a simple matter; therefore, there are no simple answers.

The cumulative noise contour is an effective tool. However, care must be exercised to ensure that the contours, used correctly, estimate the noise resulting from aircraft operations conducted at an airport.

The size and shape of the single-event contours, which are inputs into the cumulative noise contours, are dependent upon numerous factors. They include:

6.2.1 Operational Factors

6.2.1.1 Aircraft Weight

Aircraft weight is dependent on the distance to be traveled, en-route winds, payload, and anticipated aircraft delay upon reaching the destination.

6.2.1.2 Engine Power Setting

The rates of ascent and descent and the noise levels emitted at the source are influenced by the power setting used.

6.2.1.3 Airport Altitude

Higher airport altitude will affect the engine performance and thus can influence noise.

6.2.2 Atmospheric Conditions - Sound Propagation

6.2.2.1 Wind

With stronger headwinds, the aircraft can take off and climb more rapidly relative to the ground. Also, winds can influence the distribution of noise in the surrounding communities.

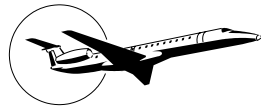
6.2.2.2 Temperature and Relative Humidity

The absorption of noise in the atmosphere along the transmission path between the aircraft and the ground observer varies with both temperature and relative humidity.

6.2.3 Surface Condition - Shielding, Extra Ground Attenuation (EGA)

Terrain - If the ground slopes down after takeoff or up before landing, noise will be reduced since the aircraft will be at a higher altitude above the ground. Additionally, hills, shrubs, trees, and large buildings can act as sound buffers.

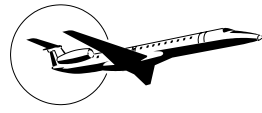
All of these factors can alter the shape and size of the contours appreciably. To demonstrate the effect of some of these factors, estimated noise level contours for two different operating conditions are shown



on figure 6.2.1. These contours reflect a given noise level upon a ground level plane at runway elevation. As indicated from these data, the contour size varies substantially with operating and atmospheric conditions. Most aircraft operations are, of course, conducted at less than the maximum gross weights because the average flight distances are much shorter than the maximum aircraft range capability and the average load factors are less than 100%. Therefore, in developing cumulative contours for planning purposes, it is recommended that the airlines serving a particular city be contacted to provide operational information.

In addition, there are no universally accepted methods for developing aircraft noise contours for relating the acceptability of specific noise zones to specific land uses. It is therefore expected that the noise contour data for a particular aircraft and the impact assessment methodology change. To ensure that currently available information of this type is used in any planning study, it is recommended that it be obtained directly from the Office of Environmental Quality in the Federal Aviation Administration in Washington, D.C.

It should be noted that the contours shown herein are only for illustrating the impact of the operating and atmospheric conditions and do not represent the single-event contour of the family of aircraft described in this document. It is expected that the cumulative contours be developed as required by the planners using the data and methodology applicable to their specific study.



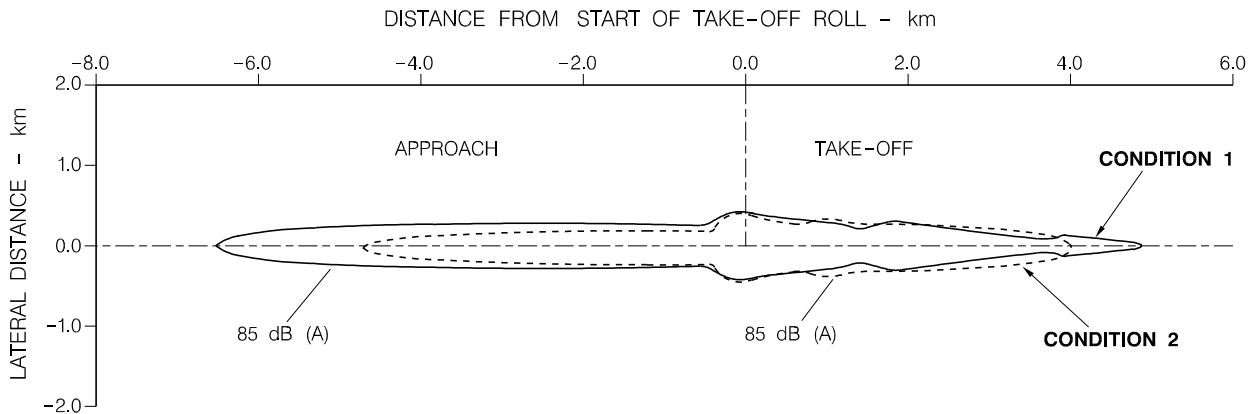
CONDITION 1

LANDING:

MAXIMUM DESIGN LANDING WEIGHT
10 knot HEADWIND
3° APPROACH
84°F
HUMIDITY 15%

TAKEOFF:

MAXIMUM DESIGN TAKEOFF WEIGHT
ZERO WIND
84°F
HUMIDITY 15%



CONDITION 2

LANDING:

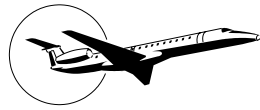
85% OF MAXIMUM DESIGN LANDING WEIGHT
10 knot HEADWIND
3° APPROACH
59°F
HUMIDITY 70%

TAKEOFF:

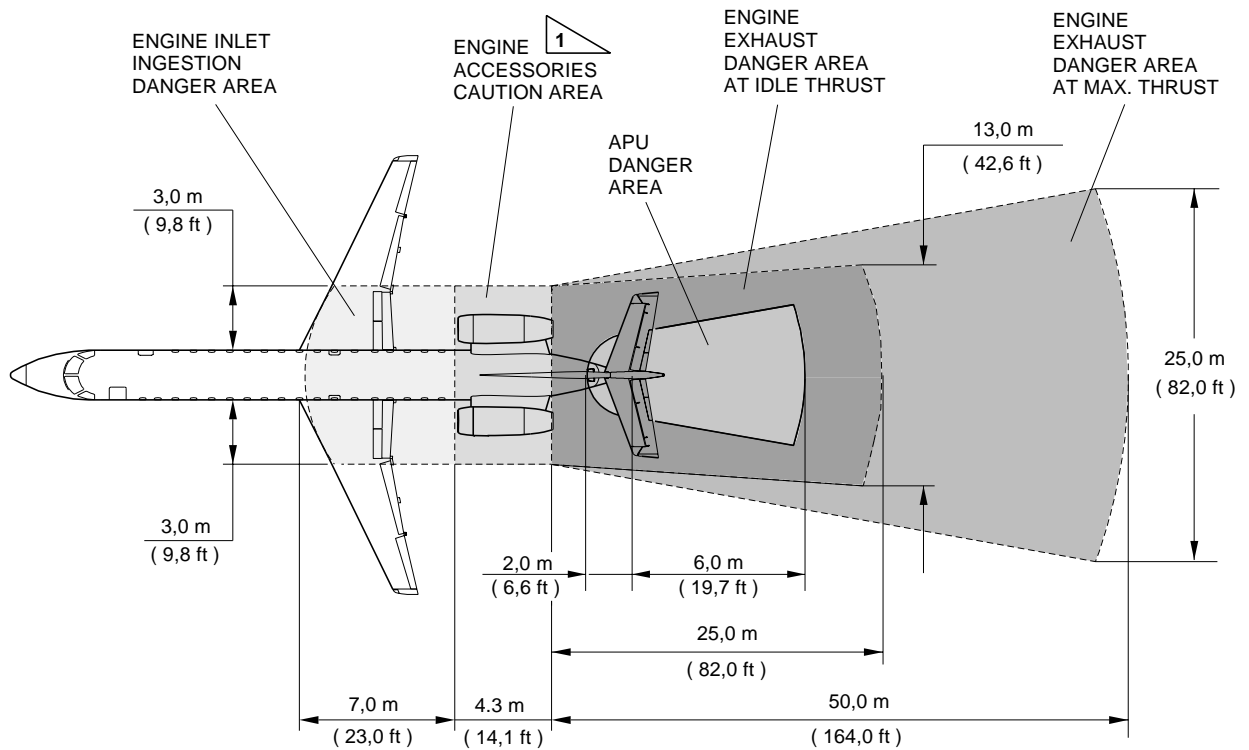
80% OF MAXIMUM DESIGN TAKEOFF WEIGHT
ZEROWIND
59°F
HUMIDITY 70%

APM060108.MCE B

Figure 6.2.1 - Airport and Community Noise Levels



6.3 Hazard Areas

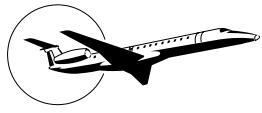


AIRCRAFT STATIC – SEA LEVEL I.S.A – NO WIND

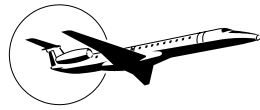
1 WITH THE ENGINE RUNNING, THE ACCESS TO THIS AREA IS PERMITTED JUST WITH THE ENGINE IN IDLE SPEED OR LESS.

145APM060022C.MCE

Figure 6.3.1 - Hazard Areas



THIS PAGE LEFT BLANK INTENTIONALLY



7. PAVEMENT DATA

7.1 General Information

Pavement or Pavement Structure is defined as a structure consisting of one or more layers of processed materials.

The primary function of a pavement is to distribute concentrated loads so that the supporting capacity of the subgrade soil is not exceeded. The subgrade soil is defined as the material on which the pavement rests, whether embankment or excavation.

Several methods for design of airport pavements have been developed that differ considerably in their approach.

Generally speaking, the design methods are derived from observation of pavements in service or experimental pavements. Thus, the reliability of any method is proportional to the amount of experimental verification behind the method, and all methods require a considerable amount of common sense and judgment on the part of the engineer who applies them.

A brief description of the following pavement charts will be helpful in their use for airport planning. Each airplane configuration is depicted with a minimum range of five loads imposed on the main landing gear to aid in the interpolation between the discrete values shown. The tire pressure used for the 145 model charts will produce the recommended tire deflection with the airplane loaded to its maximum ramp weight and with center of gravity position. The tire pressure where specifically designated in tables and on charts are values obtained under loaded conditions as certificated for commercial use.

Subsection 7.2 presents basic data on the landing gear footprint configuration, maximum design taxi loads, and tire sizes and pressures.

Maximum pavement loads for certain critical conditions at the tire-ground interfaces are shown in Subsection 7.3.

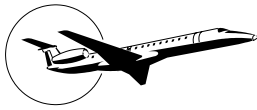
Pavement requirements for commercial airplanes are customarily derived from the static analysis of loads imposed on the main landing gear struts. The chart in Subsection 7.4 is provided in order to determine these loads throughout the stability limits of the airplane at rest on the pavement. These main landing gear loads are used to enter the pavement design charts which follow, interpolating load values where necessary.

The flexible pavement design curves (Subsection 7.5) are based on procedures set forth in Instruction Report No. S-77-1, "Procedures for Development of CBR Design Curves", dated June 1977, and as modified according to the methods described in FAA Advisory Circular 150/5320-6D, "Airport Pavement Design and Evaluation", dated July 7, 1995. Instruction Report No. S-77-1 was prepared by the US Army Corps of Engineers Waterways Experiment Station, Soils and Pavements Laboratory, Vicksburg, Mississippi. The line showing 10,000 coverages is used to calculate Aircraft Classification Number (ACN).

The LCN Method curves for flexible pavements (Subsection 7.6) have been built using procedures and curves in the International Civil Aviation Organization (ICAO) Aerodrome Design Manual, Part 3 - Pavements, Document 9157-AN/901, 1983.

The same chart includes the data of equivalent single-wheel load versus pavement thickness.

Rigid pavement design curves (Subsection 7.7) have been prepared with the use of the Westergaard Equation in general accordance with the procedures outlined in the 1955 edition of "Design of Concrete Airport Pavement" published by the Portland Cement Association, 33 W. Grand Ave., Chicago 10, Illinois, but modified to the new format described in the 1968 Portland Cement Association publication,



“Computer Program for Concrete Airport Pavement Design” (Program PDILB) by Robert G. Packard. The following procedure is used to develop rigid pavement design curves such as that shown in Subsection 7.7.

1. Once the scale for the pavement thickness to the left and the scale for allowable working stress to the right have been established, an arbitrary load line is drawn representing the main landing gear maximum weight to be shown.
2. All values of the subgrade modulus (k-values) are then plotted.
3. Additional load lines for the incremental values of weight on the main landing gear are then established on the basis of the curve for $k = 300$, already established.

The LCN conversion curves for rigid pavements (Subsection 7.8) have been built using procedures and curves in (ICAO) Aerodrome Design Manual, Part 3 - Pavements, Document 9157-AN/901, 1983.

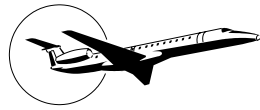
The same chart includes the data of equivalent single-wheel load versus radius of relative stiffness. Radius of relative stiffness values is obtained from Subsections 7.8.1 and 7.8.2.

The ACN/PCN system as referenced in Amendment 35 to ICAO Annex 14, “Aerodromes”, 7th Edition, June 1976, provides a standardized international airplane/pavement rating system replacing the various S, T, TT, LCN, AUW, ISWL, etc., rating systems used throughout the world. ACN is the Aircraft Classification Number and PCN is the corresponding Pavement Classification Number. An aircraft having an ACN equal to or less than the PCN can operate without restriction on the pavement.

Numerically, the ACN is two times the derived single wheel load expressed in thousands of kilograms where the derived single-wheel load is defined as the load on a single tire inflated to 1.25 Mpa (181 psi) that would have the same pavement requirements as the aircraft. Computationally, the ACN/PCN system uses PCA program PDILB for rigid pavements and S-77-1 for flexible pavements to calculate ACN values. The method of pavement evaluation is left up to the airport with the results of their evaluation presented as follows:

Table 7.1.1 - Pavement Evaluation

PAVEMENT TYPE	SUBGRADE CATEGORY	TIRE PRESSURE CATEGORY	METHOD
R - Rigid	A - High	W - No Limit	T - Technical
S - Flexible	B - Medium	X - to 1.75 Mpa (254 psi)	U - Using acft
	C - Low	Y - to 1.25 Mpa (181 psi)	
	D - Ultra Low	Z - to 0.5 Mpa (73 psi)	
Report example: PCN 80/R/B/X/T, where:			
80 = Pavement Classification Number			
R = Pavement Type: Rigid			
B = Subgrade Category: Medium			
X = Tire Pressure Category: Medium (limited to 1.5 Mpa)			
T = Evaluation Method: Technical			

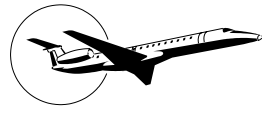


Subsection 7.9.1 shows the aircraft ACN values for flexible pavements. The four subgrade categories are:

- A. High Strength - CBR 15
- B. Medium Strength - CBR 10
- C. Low Strength - CBR 6
- D. Ultra Low Strength - CBR 3

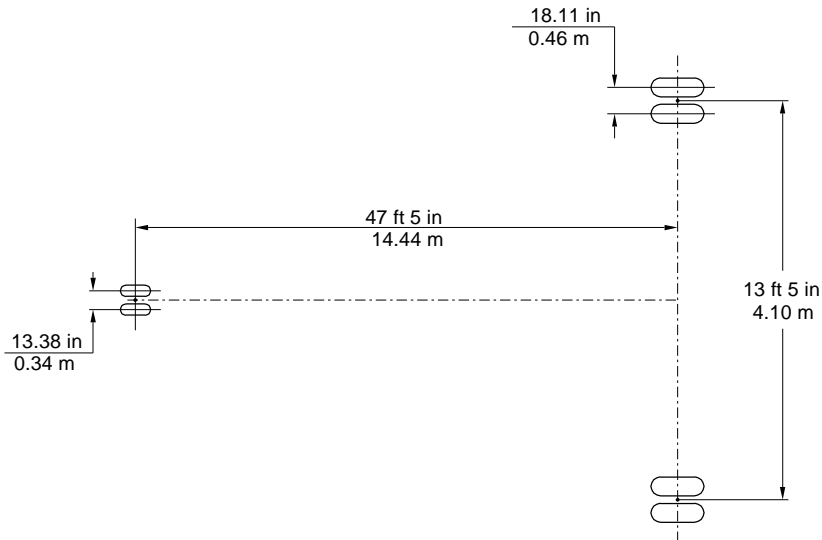
Subsection 7.9.2 shows the aircraft ACN values for rigid pavements. The four subgrade categories are:

- A. High Strength - Subgrade $k = 150 \text{ MN/m}^3$ (550 lb/in^3)
- B. Medium Strength - $k = 80 \text{ MN/m}^3$ (300 lb/in^3)
- C. Low Strength - $k = 40 \text{ MN/m}^3$ (150 lb/in^3)
- D. Ultra Low Strength - $k = 20 \text{ MN/m}^3$ (75 lb/in^3)



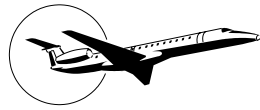
7.2 Footprint

		EMB-145 MODELS					
		ER	EU	EP	MP / MK	LR / LU	XR
MAXIMUM DESIGN TAXI WEIGHT	lb	45635	44290	46495	46495	48722	53352
	kg	20700	20090	21090	21090	22100	24200
PERCENT OF WEIGHT ON MAIN GEAR		SEE SUBSECTION 7.4					
NOSE TIRE SIZE		19.5 x 6.75-8					
NOSE TIRE PRESSURE	psi	82-0/+4				84-2/+2	
	kg/cm ²	5.77-0/+0.28				5.90-0/+0.28	
MAIN GEAR TIRE SIZE		30 x 9.5-14				H30 x 9.5-16	
MAIN GEAR TIRE PRESSURE	psi	145-0/+5	145-0/+5	148-0/+5	150 ± 3	160 ± 4	175 ± 4
	kg/cm ²	10.19-0/+0.35	10.19-0/+0.35	10.40-0/+0.35	10.55 ± 0.21	11.25 ± 0.28	12.30 ± 0.28



145APM070044.MCE E

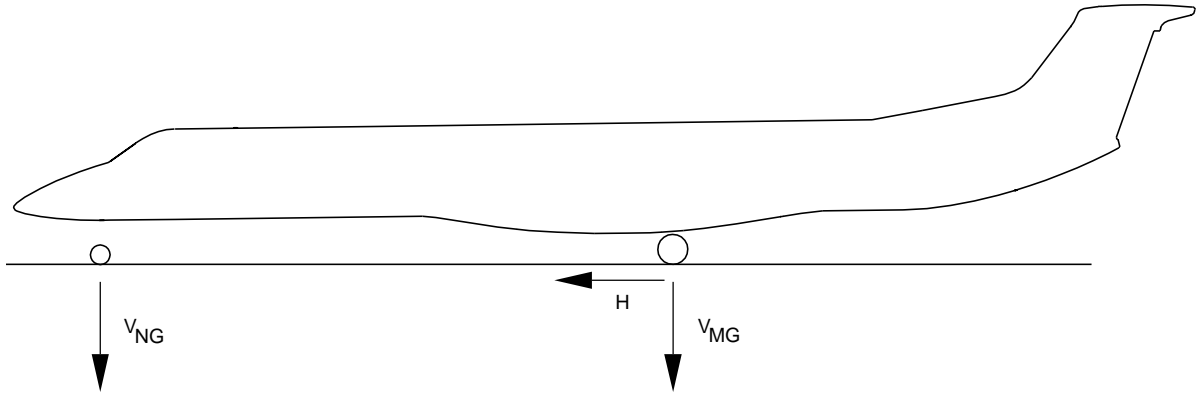
Figure 7.2.1 - Footprint



7.3 Maximum Pavement Loads

LEGEND: V_{NG} = MAXIMUM VERTICAL NOSE GEAR GROUND LOAD AT MOST FORWARD C.G.
 V_{MG} = MAXIMUM VERTICAL MAIN GEAR GROUND LOAD AT MOST FORWARD C.G.
 H = MAXIMUM HORIZONTAL GROUND LOAD FROM BRAKING

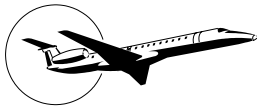
NOTE: ALL LOADS CALCULATED USING AIRPLANE MAXIMUM DESIGN TAXI WEIGHT



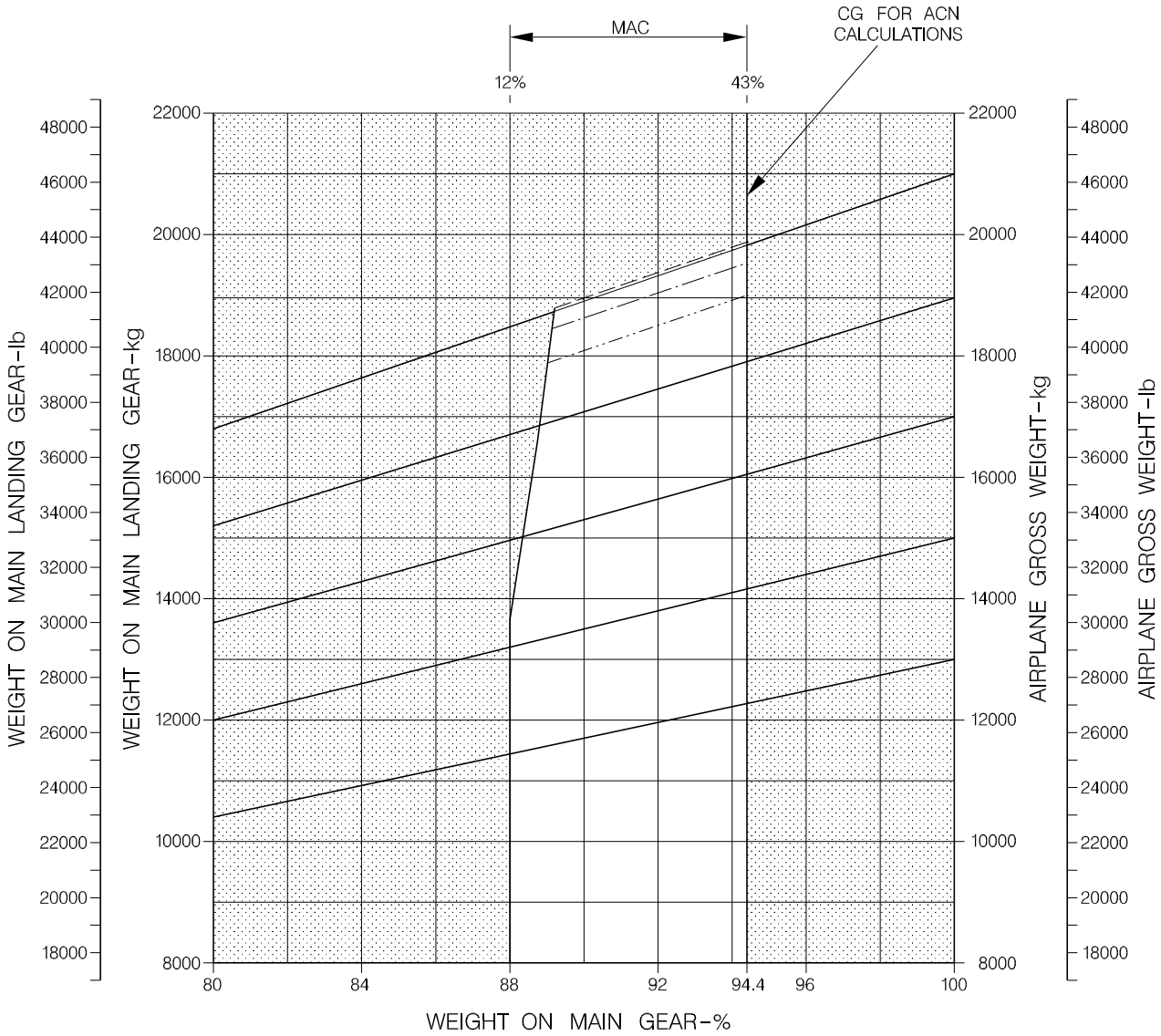
MODEL	MAXIMUM DESIGN TAXI WEIGHT		V_{NG}				V_{MG} (PER STRUT)		H (PER STRUT)			
			STATIC AT MOST FORWARD C.G.		STATIC+BRAKING 10 ft/sec ² DECELERATION 3,048m/sec ²		MAXIMUM LOAD OCCURRING AT STATIC AFT C.G.		AT STEADY BRAKING 10 ft/sec ² DECELERATION 3,048m/sec ²		AT INSTANTANEOUS BRAKING (COEFF. OF FRICTION 0.8)	
			lb	kg	lb	kg	lb	kg	lb	kg	lb	kg
EMB-145 ER	45640	20700	4972	2255	6738	3056	21532	9766	6381	2894	18262	8283
EMB-145 EU	44295	20090	4879	2213	6595	2991	20897	9478	6193	2809	17722	8038
EMB-145 EP	46499	21090	5027	2280	6824	3095	21938	9950	6502	2949	18606	8439
EMB-145 LR	48725	22100	5170	2345	7055	3200	24255	11000	6835	3100	19500	8845
EMB-145 MR	48725	22100	5170	2345	7055	3200	24255	11000	6835	3100	19500	8845
EMB-145 LU	48725	22100	5170	2345	7055	3200	24255	11000	6835	3100	19500	8845
EMB-145 MP	46499	21090	5027	2280	6824	3095	21938	9950	6502	2949	18606	8439
EMB-145 MK	44295	20090	4879	2213	6595	2991	20897	9478	6193	2809	17722	8038
EMB-145 XR	53352	24200	5453	2473	7464	3385	26217	11890	7801	3538	18956	8597

145APM070045.MCE D

Figure 7.3.1 - Maximum Pavement Loads



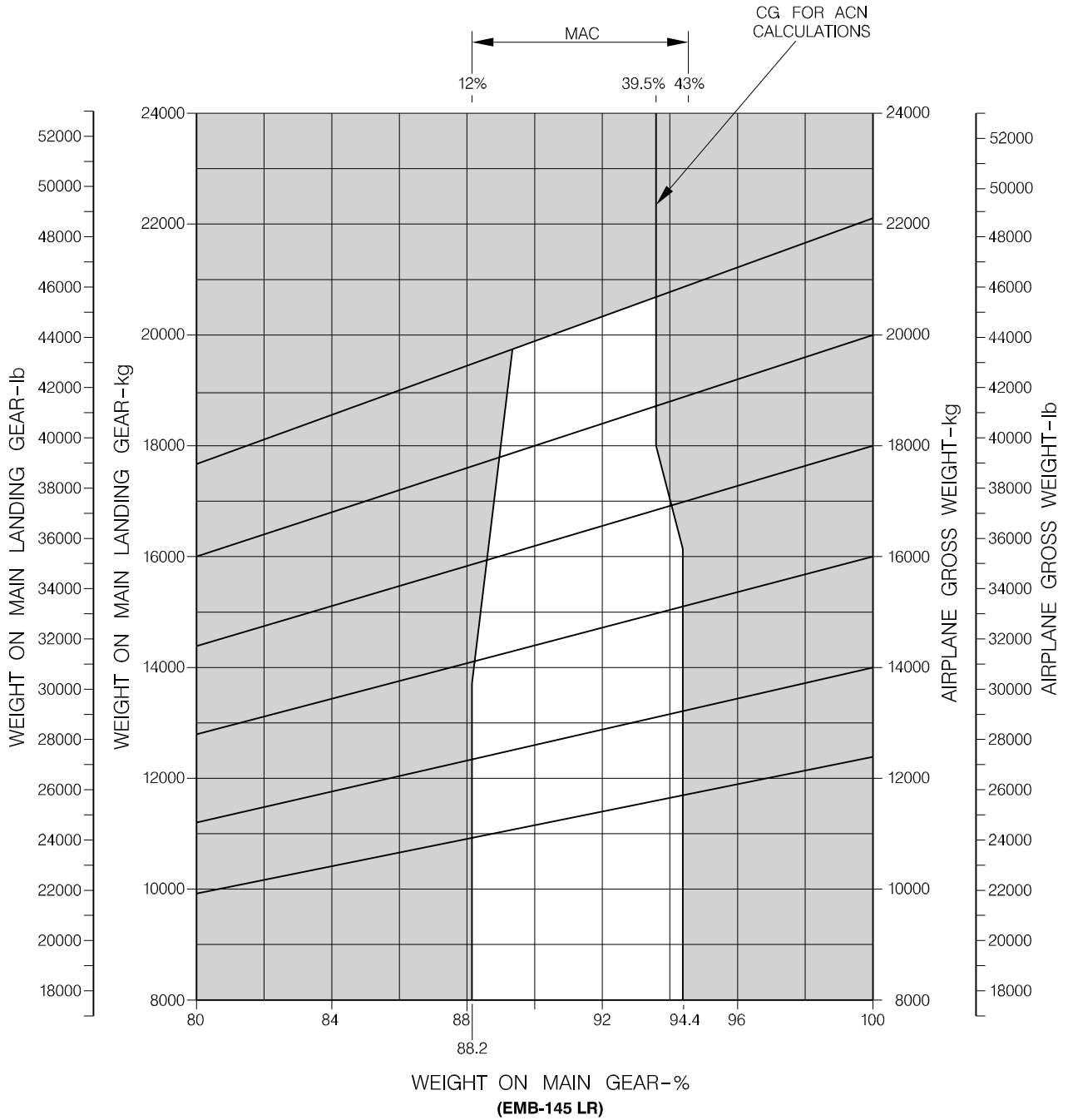
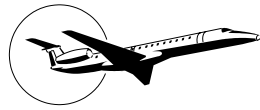
7.4 Landing Gear Loading on Pavement



LEGEND	
— · — · —	EMB-145 ER
— · — · —	EMB-145 EU
— · — · —	EMB-145 EP

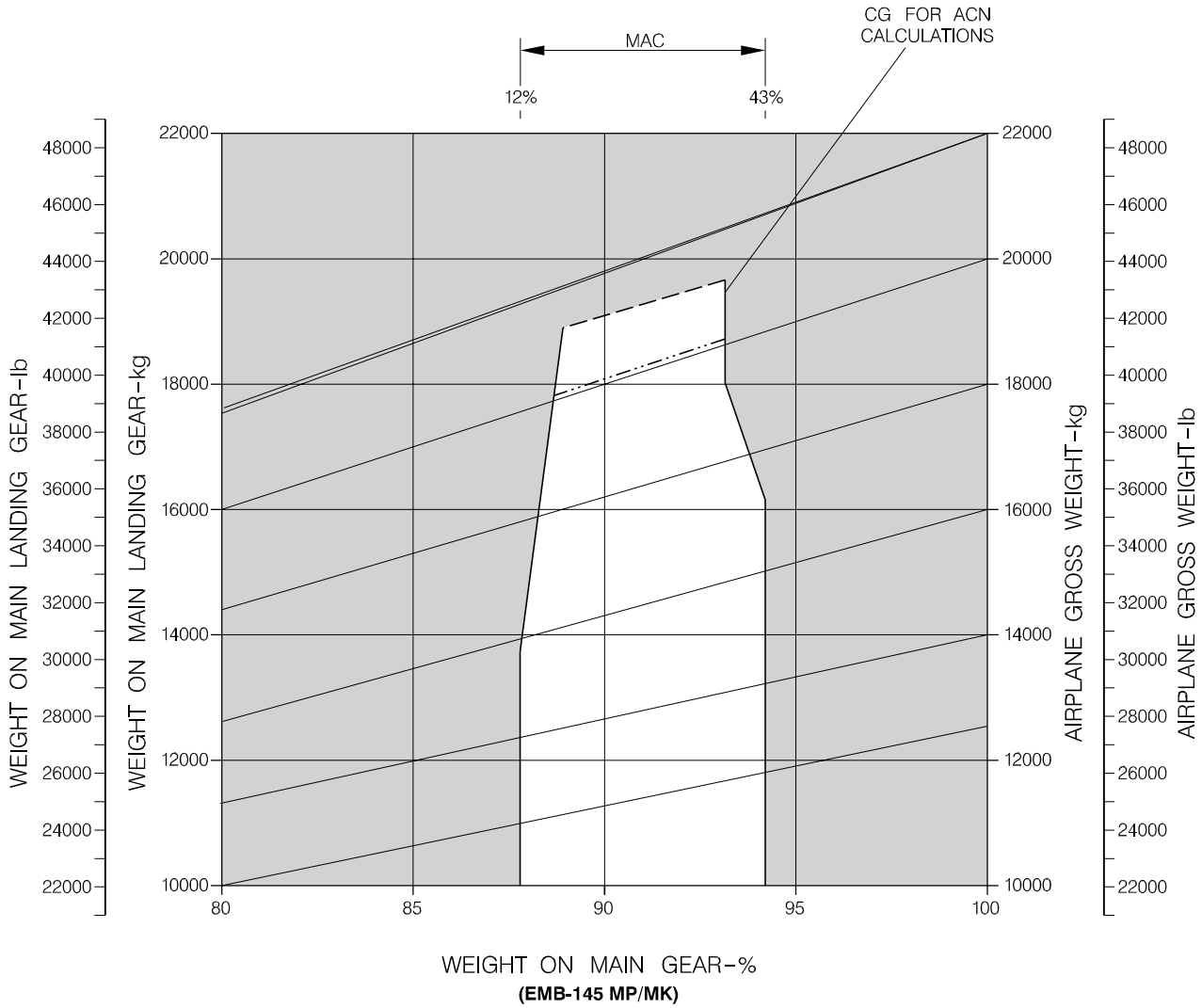
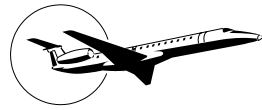
145AP051.MCE A

*Figure 7.4.1 - Landing Gear Loading on Pavement
Sheet 1*



APM070055.MCE A

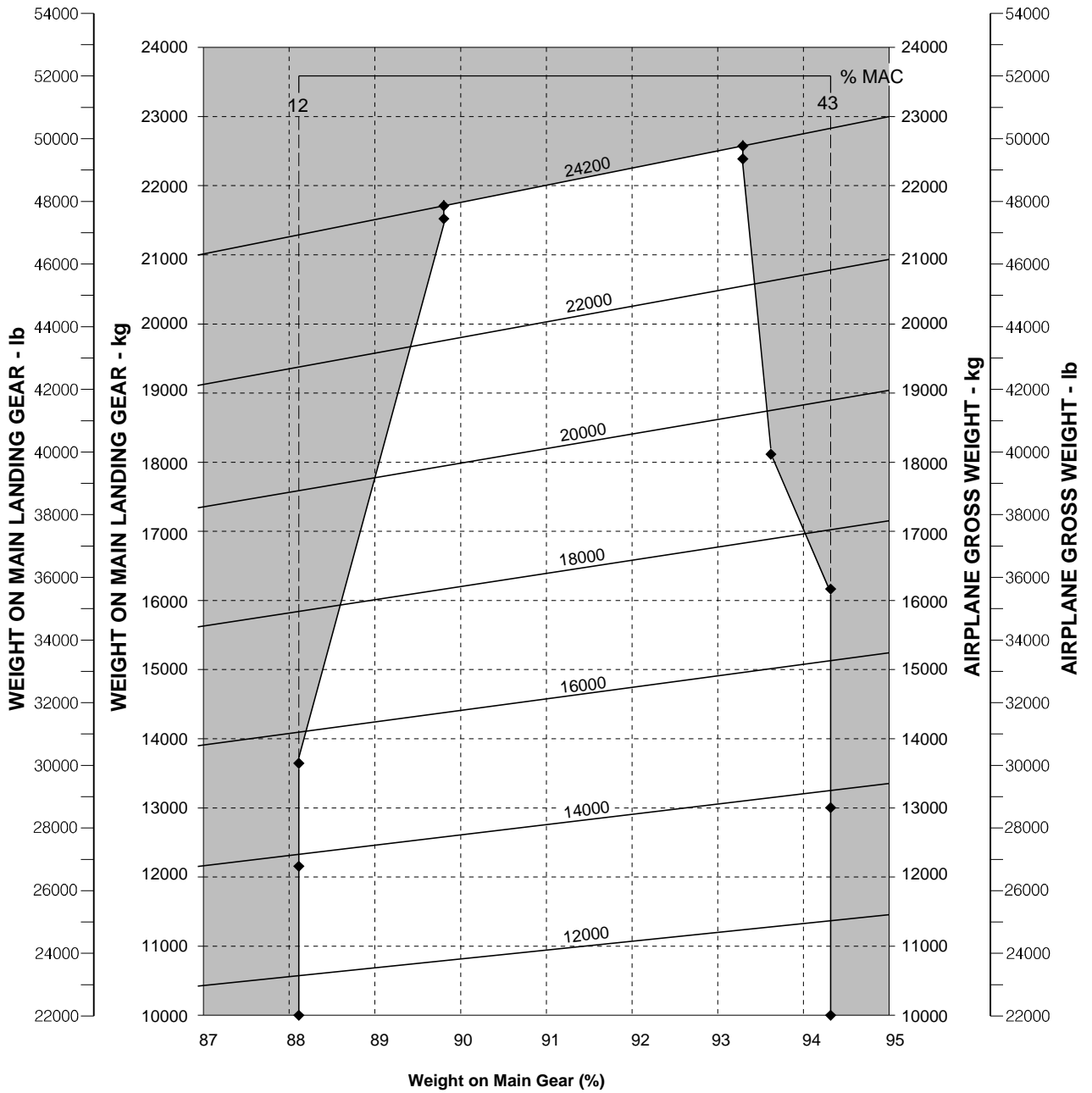
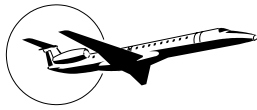
*Figure 7.4.1 - Landing Gear Loading on Pavement
Sheet 2*



LEGEND	
---	EMB-145 MP
- · - · -	EMB-145 MK

APM070776.MCE

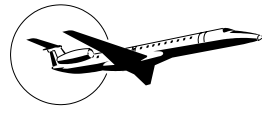
*Figure 7.4.1 - Landing Gear Loading on Pavement
Sheet 3*



EMB-145XR

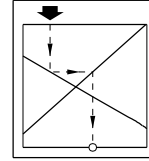
145APM070814.MCE

Figure 7.4.1 - Landing Gear Loading on Pavement
Sheet 4



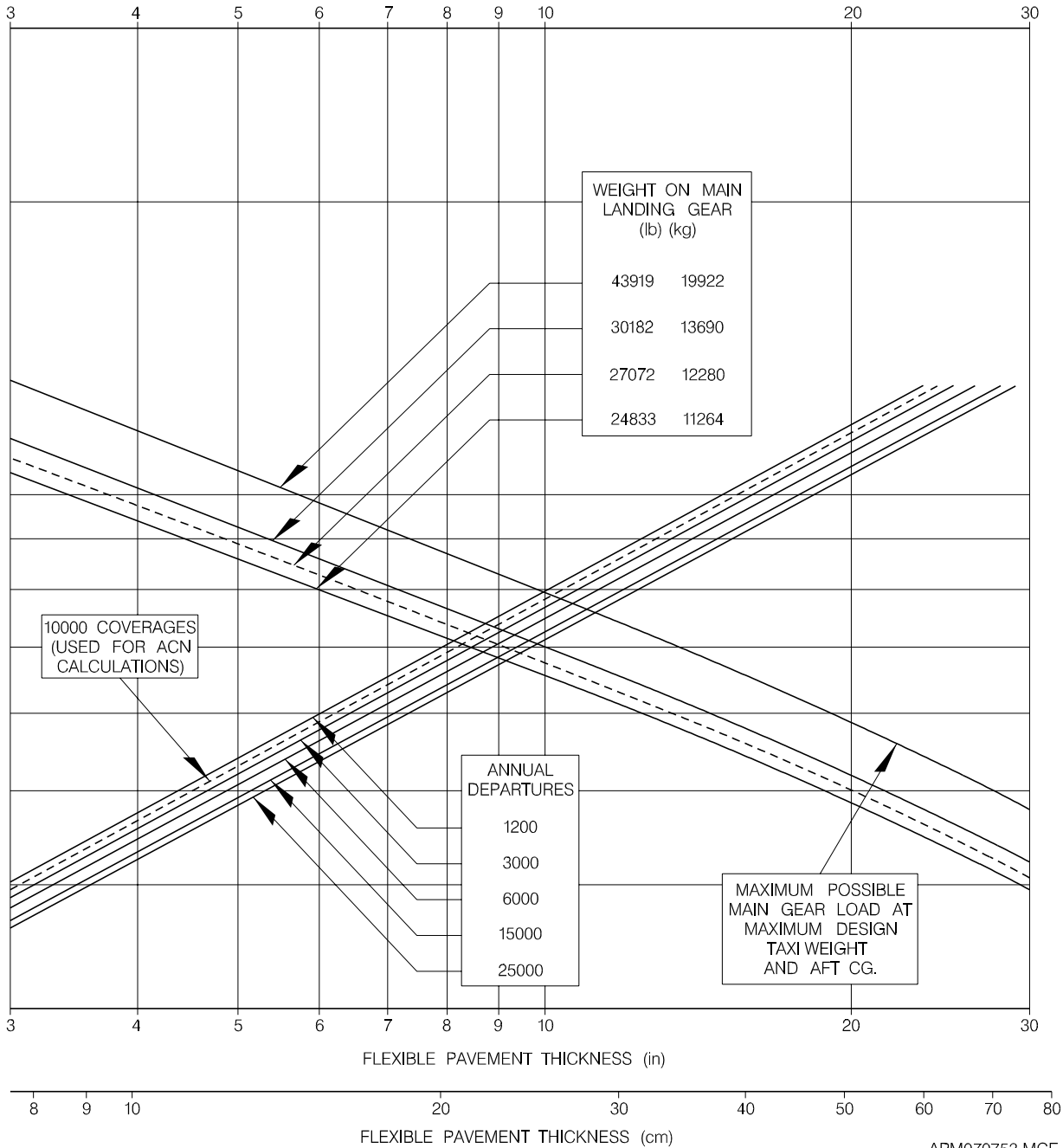
7.5 Flexible Pavement Requirements - US Army Corps of Engineers Design Method

NOTES: TIRES 30x9.5x14 16PR - TIRES PRESSURE AT 10.19kg/cm² (145psi)

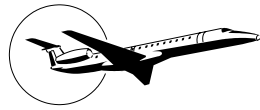


SUBGRADE STRENGTH - CBR

EMB-145 EU/ER

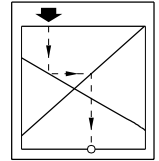


**Figure 7.5.1 - Flexible Pavement Requirements - US Army Corps of Engineers Design Method
Sheet 1**

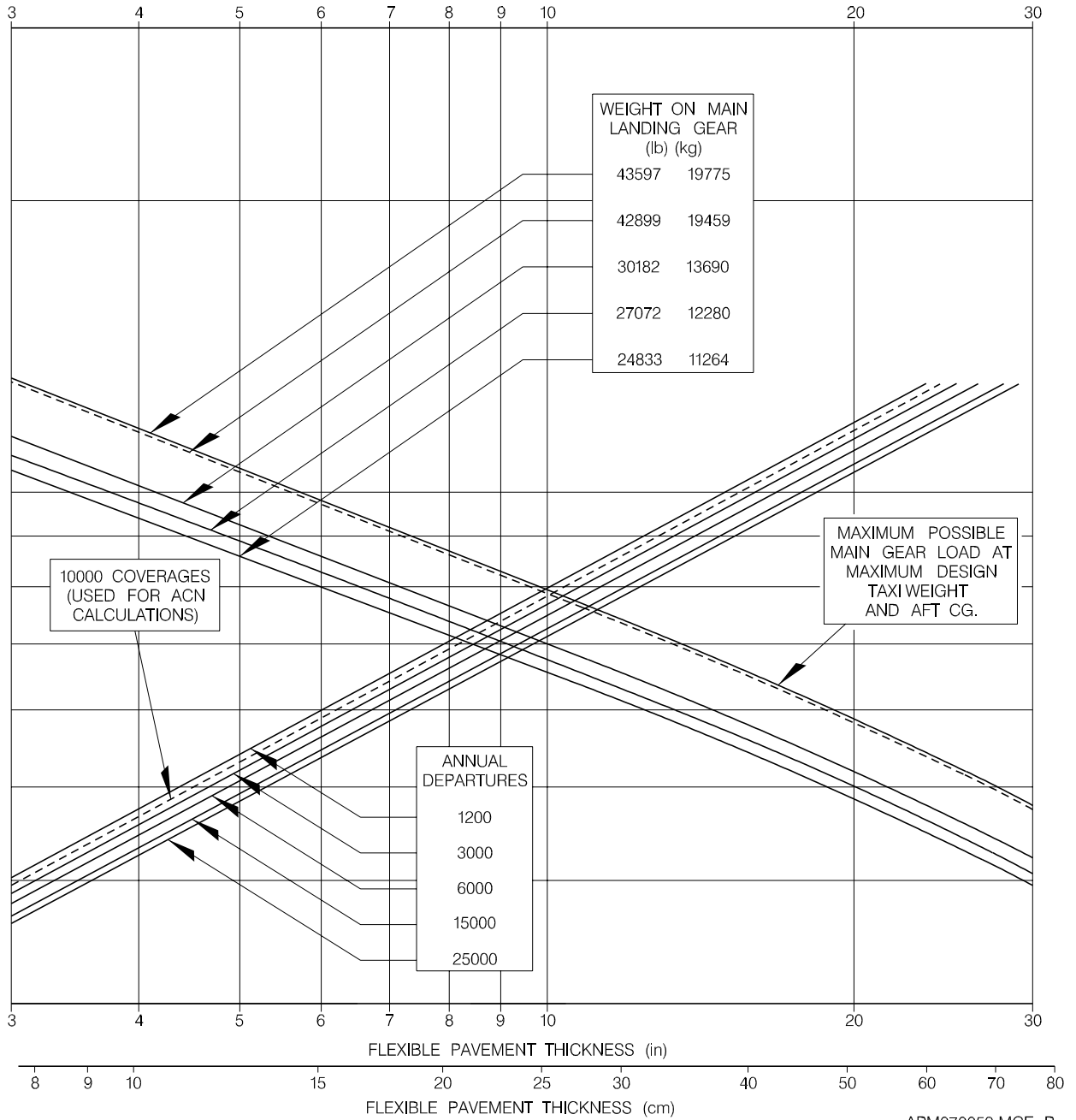


NOTES: TIRES 30x9.5x14 16PR - TIRE PRESSURE AT 10.41kg/cm² (148psi)

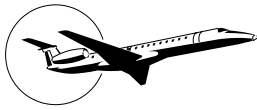
SUBGRADE STRENGTH - CBR



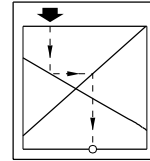
EMB-145 EP



*Figure 7.5.1 - Flexible Pavement Requirements - US Army Corps of Engineers Design Method
Sheet 2*

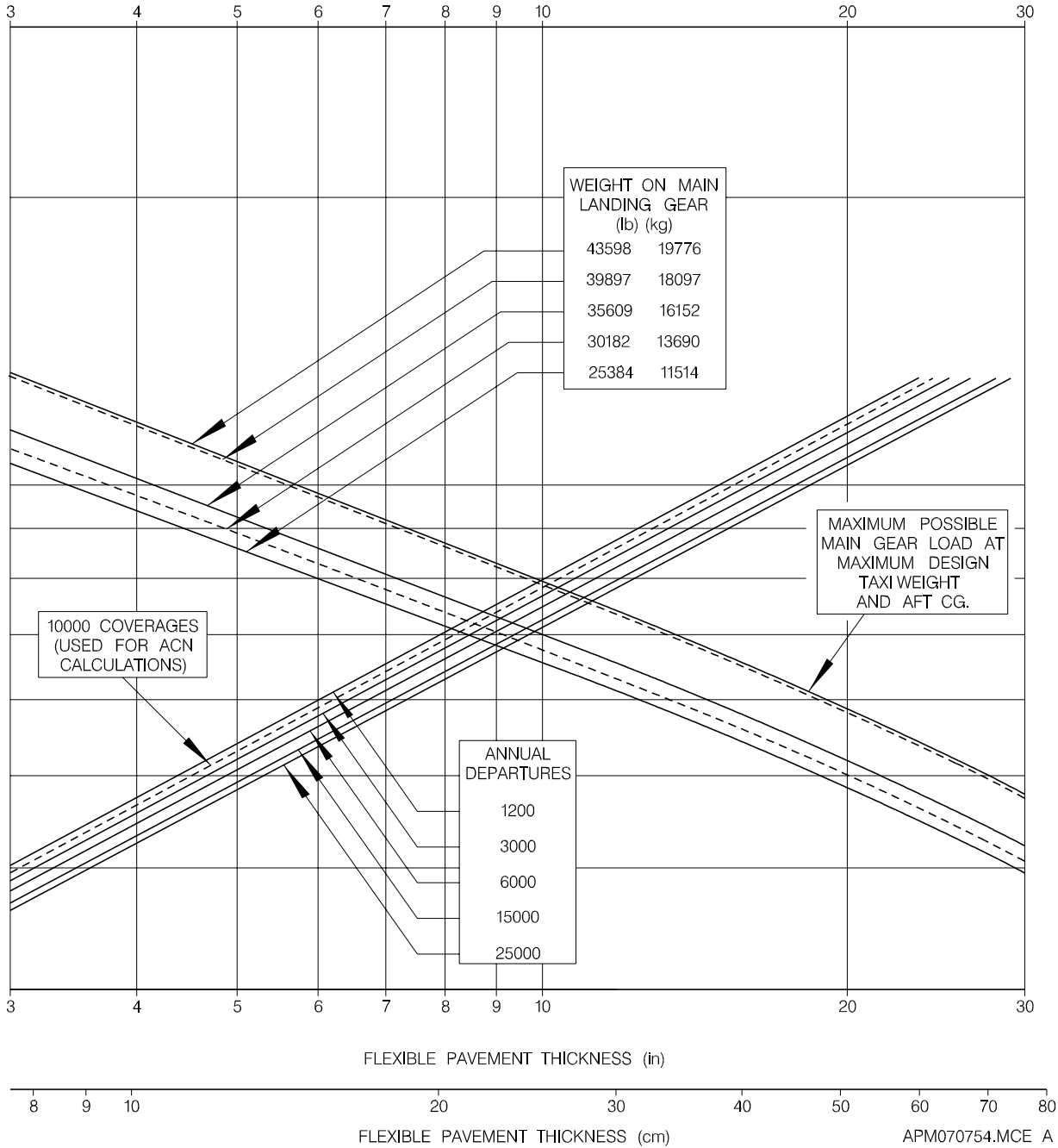


NOTES: TIRES 30x9.5x14, 16PR - TIRES PRESSURE AT 10.55 kgf/cm² (150 psi)

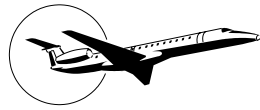


SUBGRADE STRENGTH - CBR

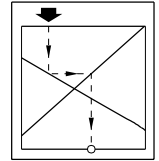
EMB-145 MP



*Figure 7.5.1 - Flexible Pavement Requirements - US Army Corps of Engineers Design Method
Sheet 3*



NOTES: TIRES H30x9.5x16, 16PR - TIRE PRESSURE AT 11.25kgf/cm² (160psi)



SUBGRADE STRENGTH - CBR

EMB-145 LR/LU

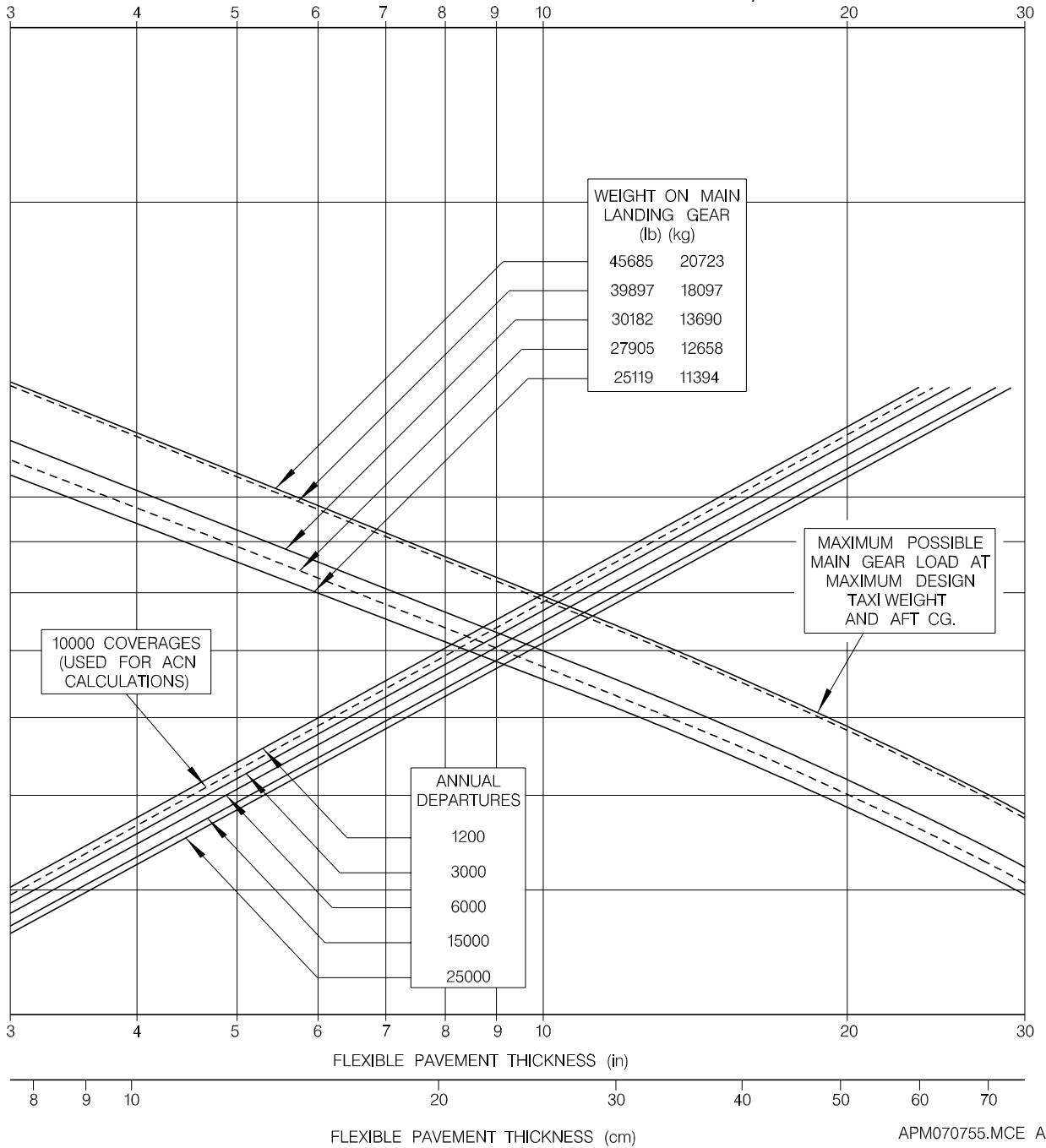
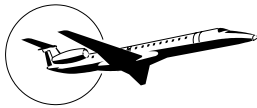
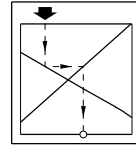


Figure 7.5.1 - Flexible Pavement Requirements - US Army Corps of Engineers Design Method Sheet 4

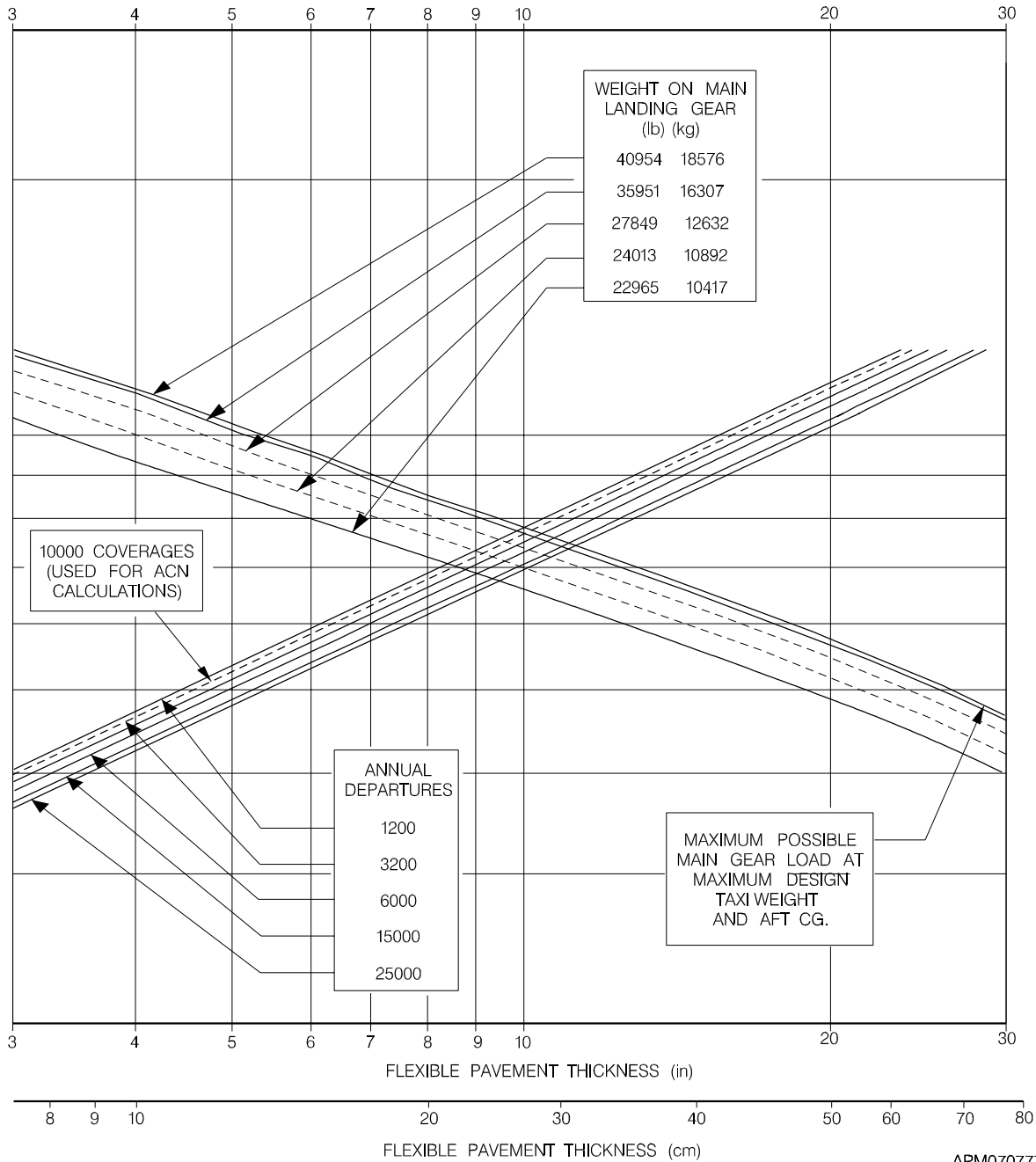


NOTES: TIRES 30x9.5x14 16PR - TIRES PRESSURE AT 10.55 kg/cm² (150 psi)

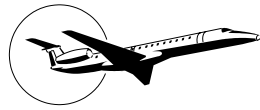


SUBGRADE STRENGTH - CBR

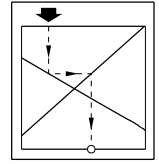
EMB-145 MK



*Figure 7.5.1 - Flexible Pavement Requirements - US Army Corps of Engineers Design Method
Sheet 5*

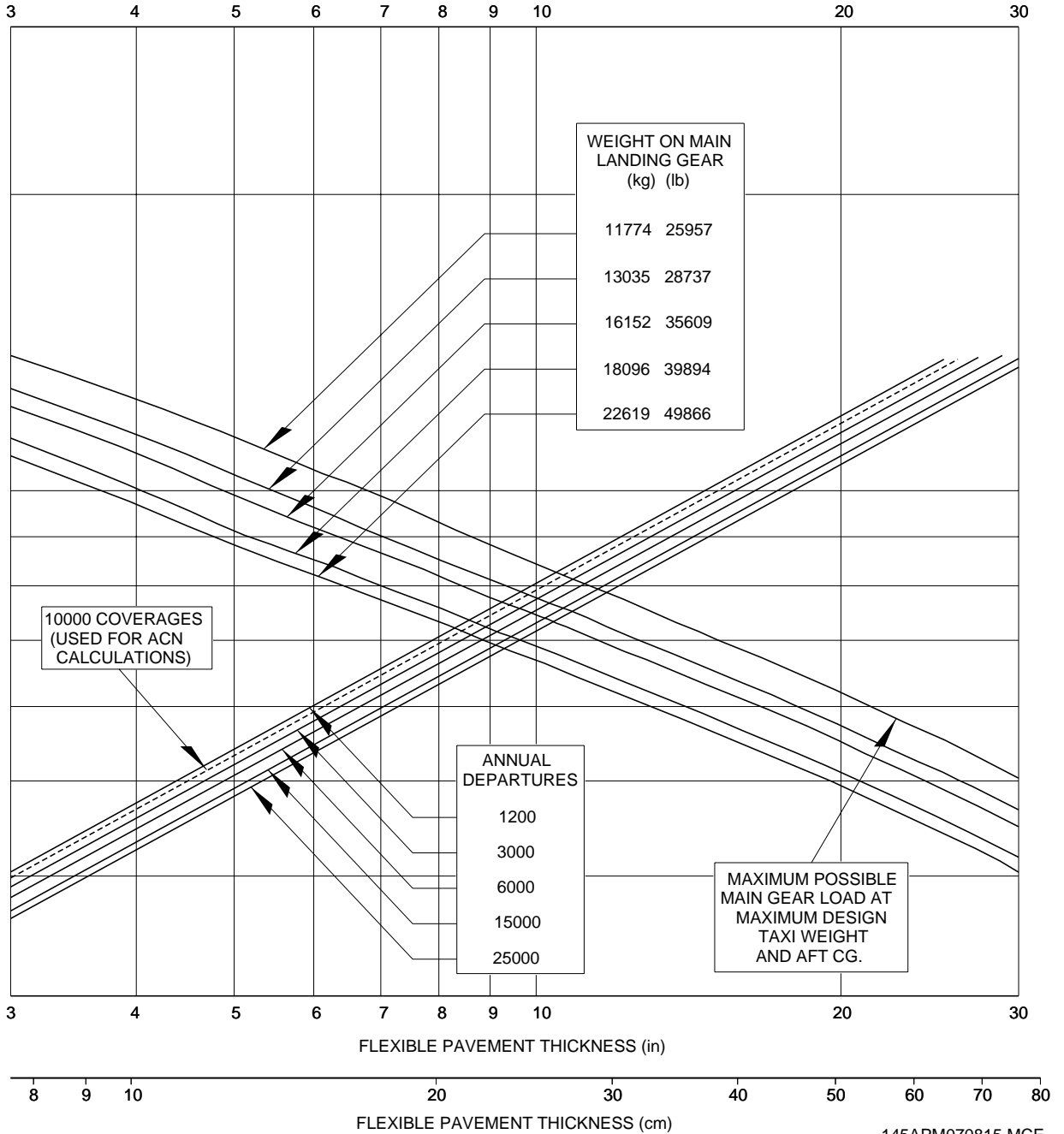


NOTES: TIRES H30x9.5x16 16PR - TIRES PRESSURE AT 12.30kg/cm²(175psi)



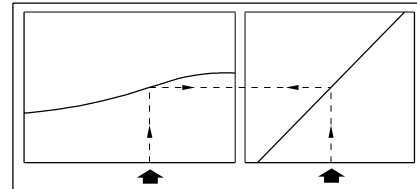
SUBGRADE STRENGTH - CBR

EMB-145 XR

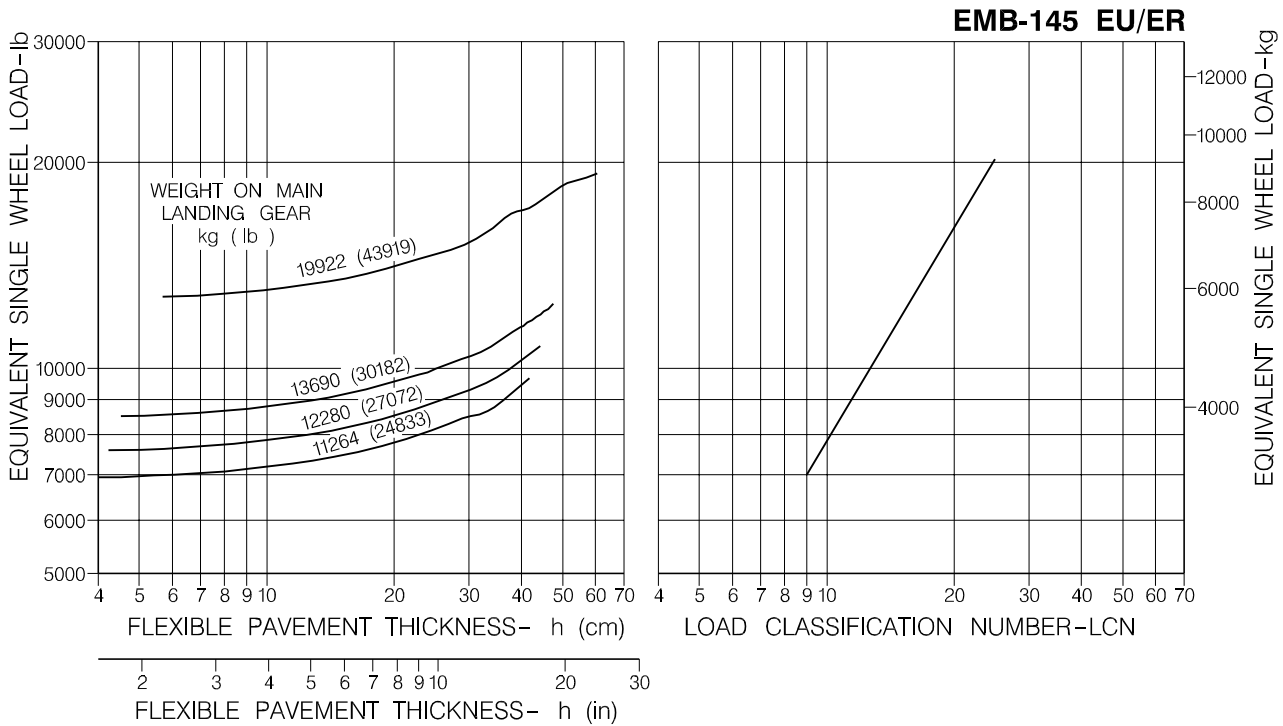


*Figure 7.5.1 - Flexible Pavement Requirements - US Army Corps of Engineers Design Method
Sheet 6*

7.6 Flexible Pavement Requirements - LCN Method



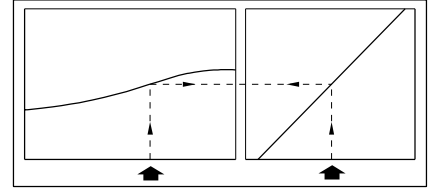
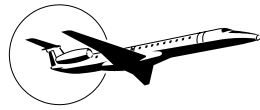
TIRES 30x9.5-14 16PR AT 10.19 kgf/cm² (145psi)



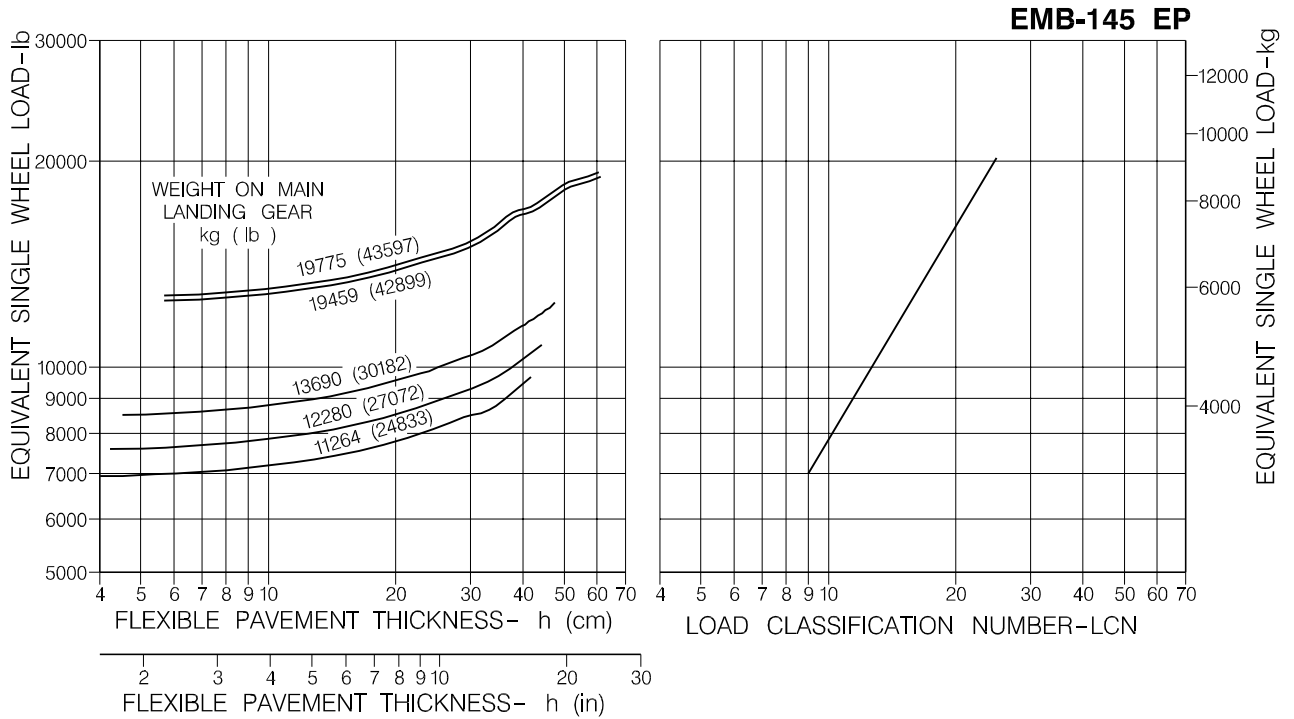
NOTE: EQUIVALENT SINGLE WHEEL LOADS ARE DERIVED BY METHODS SHOWN IN I C A O AERODROME MANUAL, PART 2, PAR. 4.1.3

APM070760.MCE A

*Figure 7.6.1 - Flexible Pavement Requirements, LCN Method
 Sheet 1*



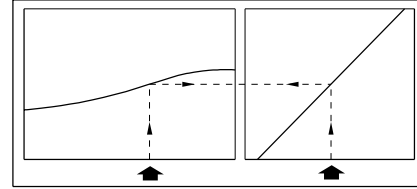
TIRES 30x9.5-14 16PR AT 10.41 kgf/cm² (148 psi)



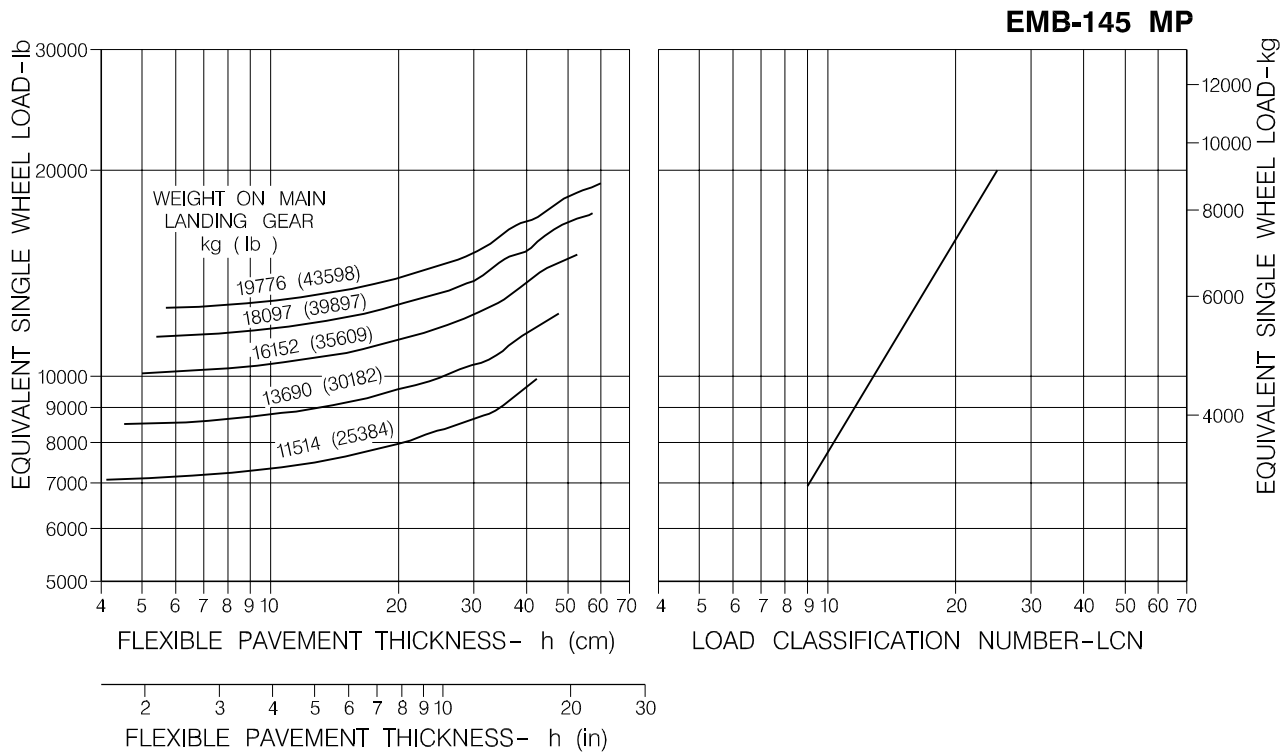
NOTE: EQUIVALENT SINGLE WHEEL LOADS ARE DERIVED BY METHODS SHOWN IN I C A O AERODROME MANUAL, PART 2, PAR. 4.1.3

APM070759.MCE A

*Figure 7.6.1 - Flexible Pavement Requirements, LCN Method
Sheet 2*



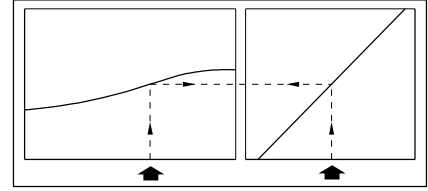
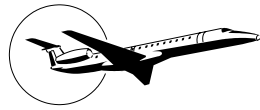
TIRES 30x9.5-14 16PR AT 10.55 kgf/cm² (150psi)



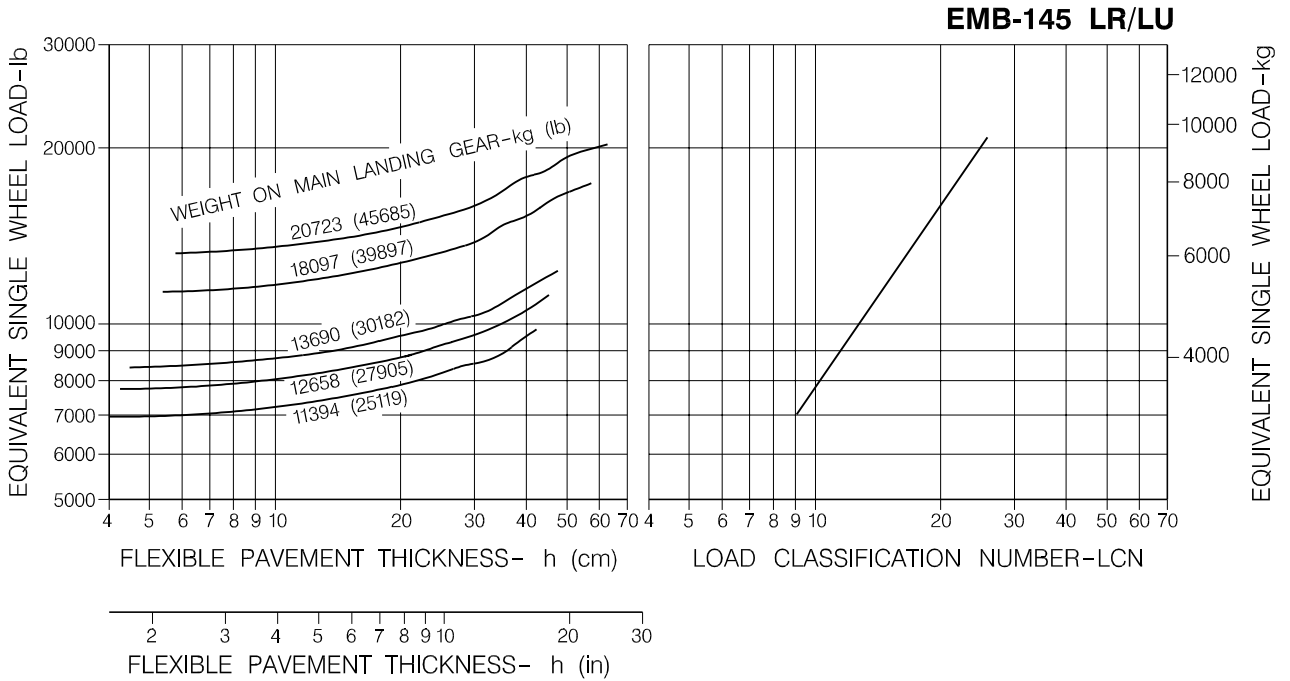
NOTE: EQUIVALENT SINGLE WHEEL LOADS ARE DERIVED BY METHODS SHOWN IN ICAO AERODROME MANUAL, PART 2, PAR. 4.1.3

APM070758.MCE A

*Figure 7.6.1 - Flexible Pavement Requirements, LCN Method
Sheet 3*



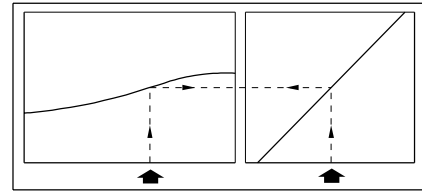
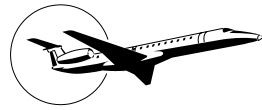
(30 x 9.5-14) TIRES - TIRE PRESSURE CONSTANT AT 11.25 kg/cm² (160 psi)



NOTE: EQUIVALENT SINGLE WHEEL LOADS ARE DERIVED BY METHODS SHOWN IN I C A O AERODROME MANUAL, PART 2, PAR. 4.1.3

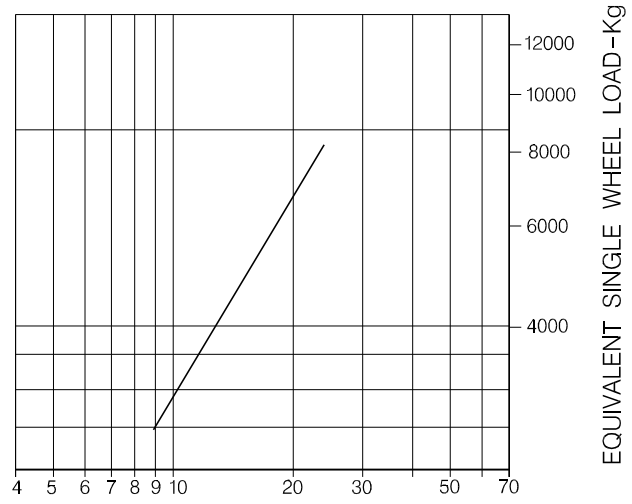
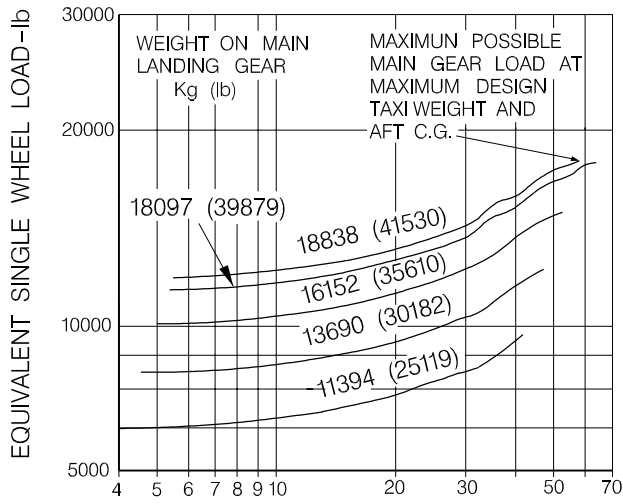
APM070057.MCE A

*Figure 7.6.1 - Flexible Pavement Requirements, LCN Method
Sheet 4*



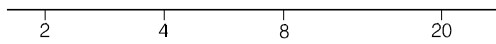
TIRES 30 x 9.5 -14 16PR AT 10,55 Kg/cm (150 psi)

EMB-145 MK



FLEXIBLE PAVEMENT THICKNESS- h (cm)

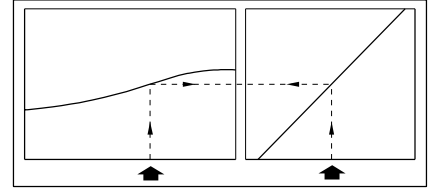
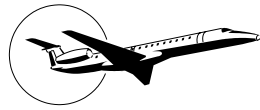
LOAD CLASSIFICATION NUMBER-LCN



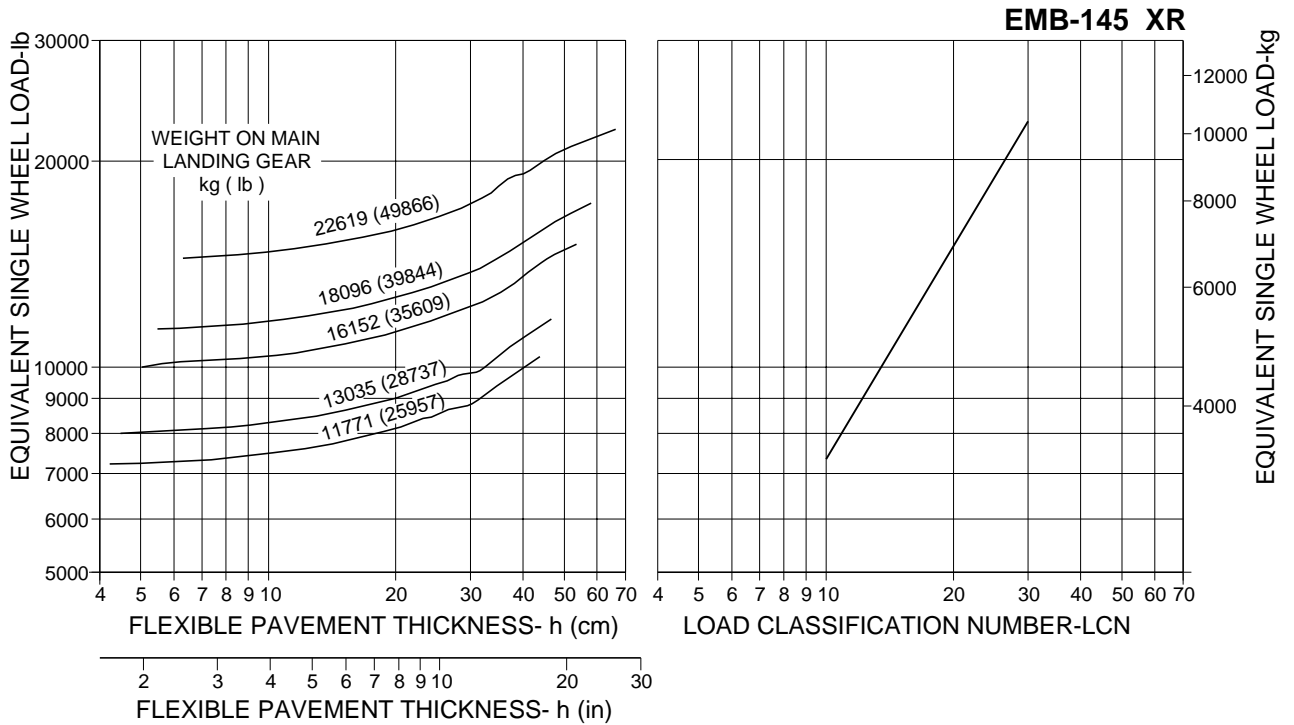
FLEXIBLE PAVEMENT THICKNESS- h (in)

APM070778.MCE

*Figure 7.6.1 - Flexible Pavement Requirements, LCN Method
Sheet 5*



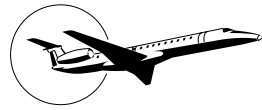
TIRES H30x9.5-16 16PR AT 12.30 kgf/cm² (175psi)



NOTE: EQUIVALENT SINGLE WHEEL LOADS ARE DERIVED BY METHODS SHOWN IN I C A O AERODROME MANUAL. PART 2, PAR. 4.1.3

145APM070816.MCE

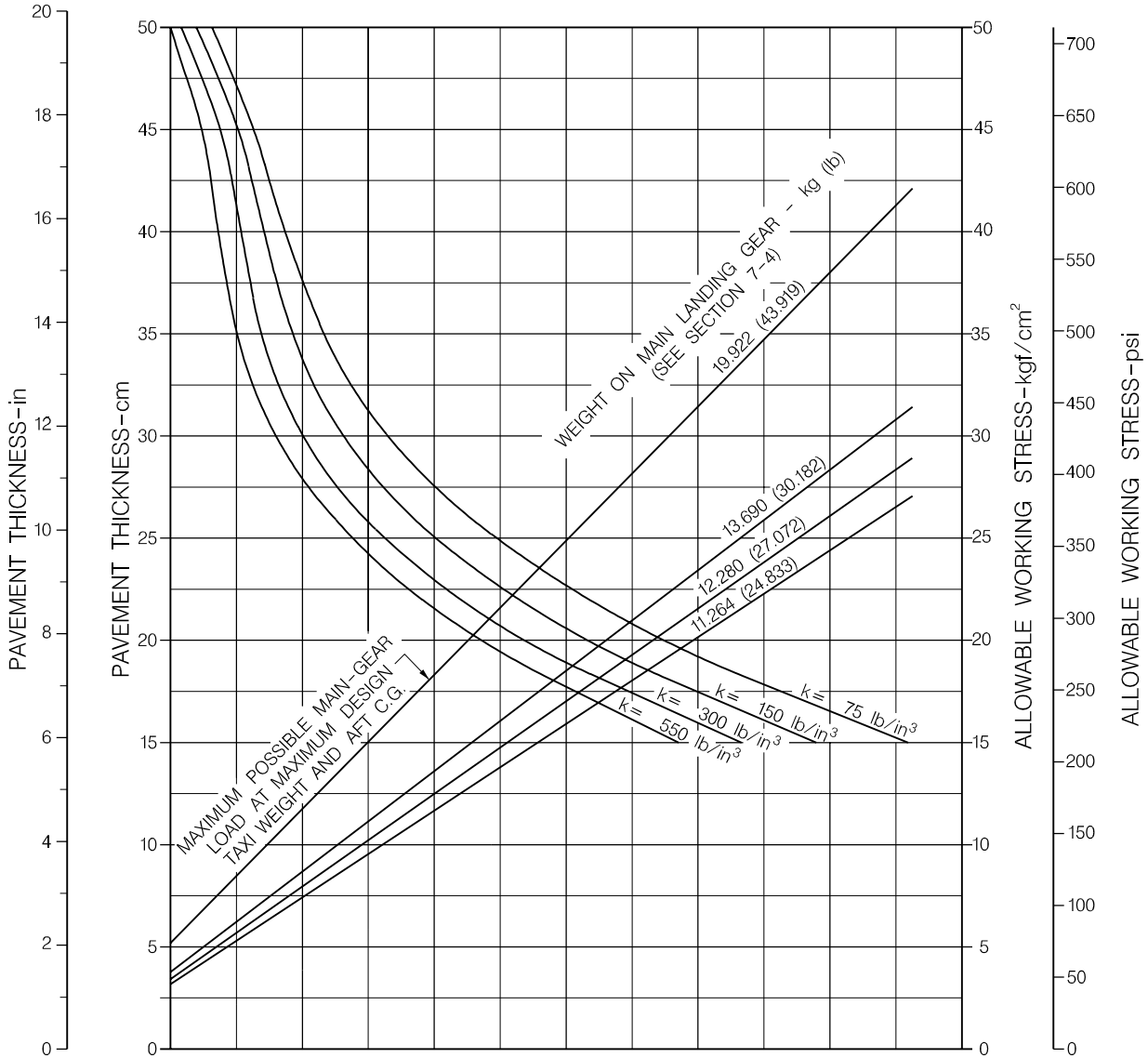
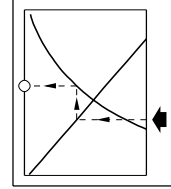
*Figure 7.6.1 - Flexible Pavement Requirements, LCN Method
Sheet 6*



7.7 Rigid Pavement Requirements - Portland Cement Association Design Method

RIGID PAVEMENT REQUIREMENTS - MODEL EMB-145 EU/ER

- NOTES:**
- 30 x 9.5-14 16PR TIRES
 - TIRE PRESSURE 10.19 kgf/cm² (145 psi) (LOADED)
 - % WEIGHT ON MAIN GEARS 94.46%

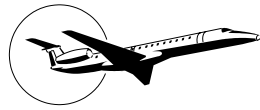


NOTE: THE VALUES OBTAINED BY USING THE MAXIMUM LOAD REFERENCE LINE AND ANY VALUE OF "K" ARE EXACT. FOR LOADS LESS THAN MAXIMUM, THE CURVES ARE EXACT FOR K=300 BUT DEVIATE SLIGHTLY FOR OTHER VALUES OF "K".

REFERENCE: PORTLAND CEMENT ASSOCIATION METHOD.

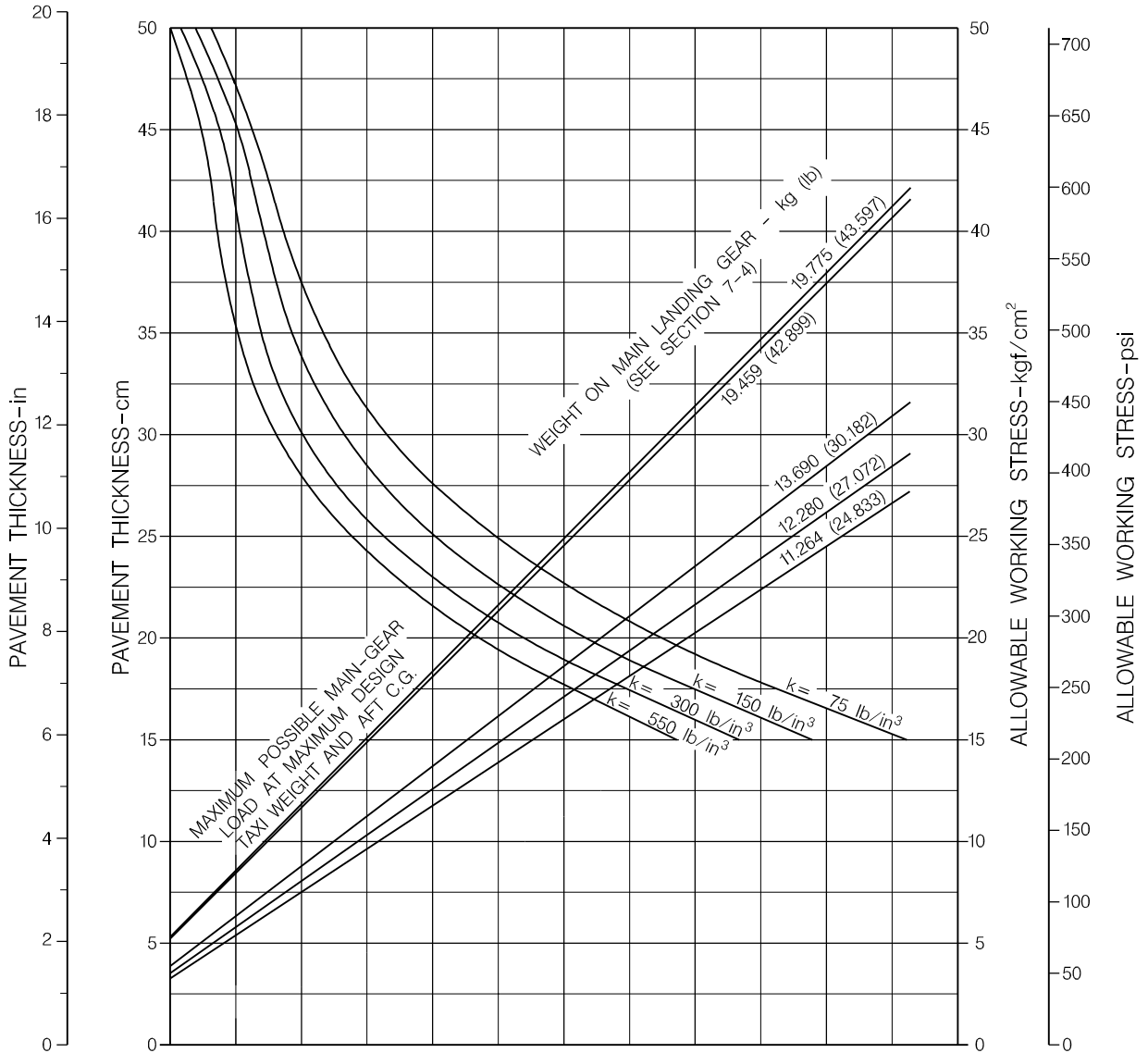
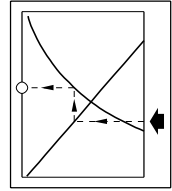
APM070056.MCE B

Figure 7.7.1 - Rigid Pavement Requirements - Portland Cement Association Design Method Sheet 1



RIGID PAVEMENT REQUIREMENTS - MODEL EMB-145 EP

- NOTES:**
- 30 x 9.5-14 16PR TIRES
 - TIRE PRESSURE 10.41 kgf/cm² (148 psi) (LOADED)
 - % WEIGHT ON MAIN GEARS 93.8%

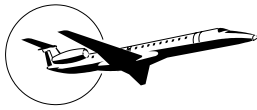


NOTE: THE VALUES OBTAINED BY USING THE MAXIMUM LOAD REFERENCE LINE AND ANY VALUE OF "K" ARE EXACT. FOR LOADS LESS THAN MAXIMUM, THE CURVES ARE EXACT FOR K=300 BUT DEVIATE SLIGHTLY FOR OTHER VALUES OF "K".

REFERENCE: PORTLAND CEMENT ASSOCIATION METHOD.

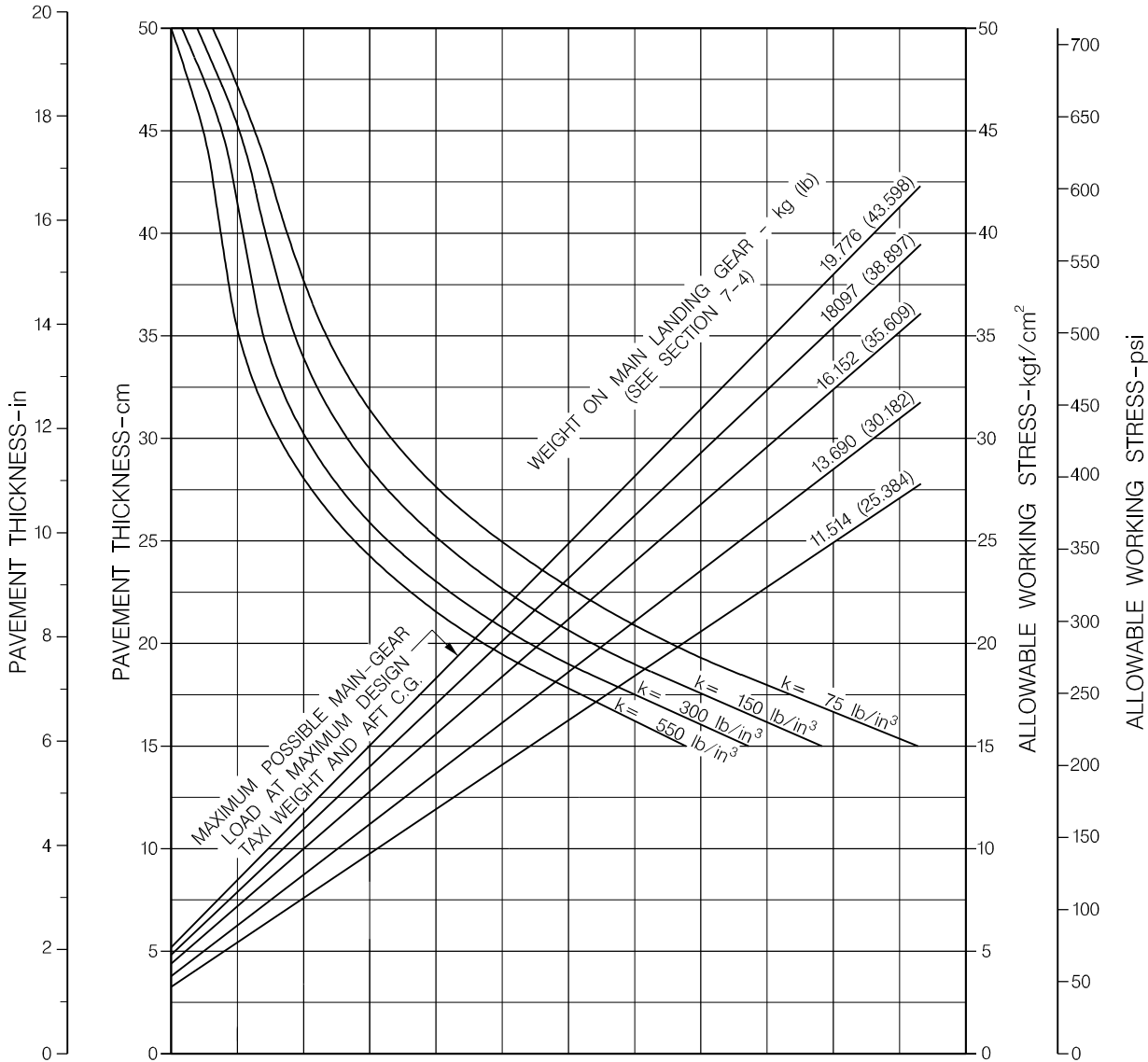
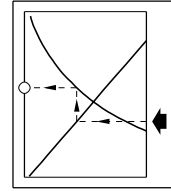
APM070764.MCE A

*Figure 7.7.1 - Rigid Pavement Requirements - Portland Cement Association Design Method
Sheet 2*



RIGID PAVEMENT REQUIREMENTS - MODEL EMB-145 MP

- NOTES:**
- 30 x 9.5-14 16PR TIRES
 - TIRE PRESSURE 10.55 kgf/cm² (150 psi) (LOADED)
 - % WEIGHT OR MAIN GEARS 93.8%

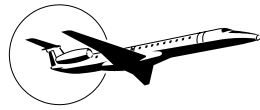


NOTE: THE VALUES OBTAINED BY USING THE MAXIMUM LOAD REFERENCE LINE AND ANY VALUE OF "K" ARE EXACT. FOR LOADS LESS THAN MAXIMUM, THE CURVES ARE EXACT FOR K=300 BUT DEVIATE SLIGHTLY FOR OTHER VALUES OF "K".

REFERENCE: PORTLAND CEMENT ASSOCIATION METHOD.

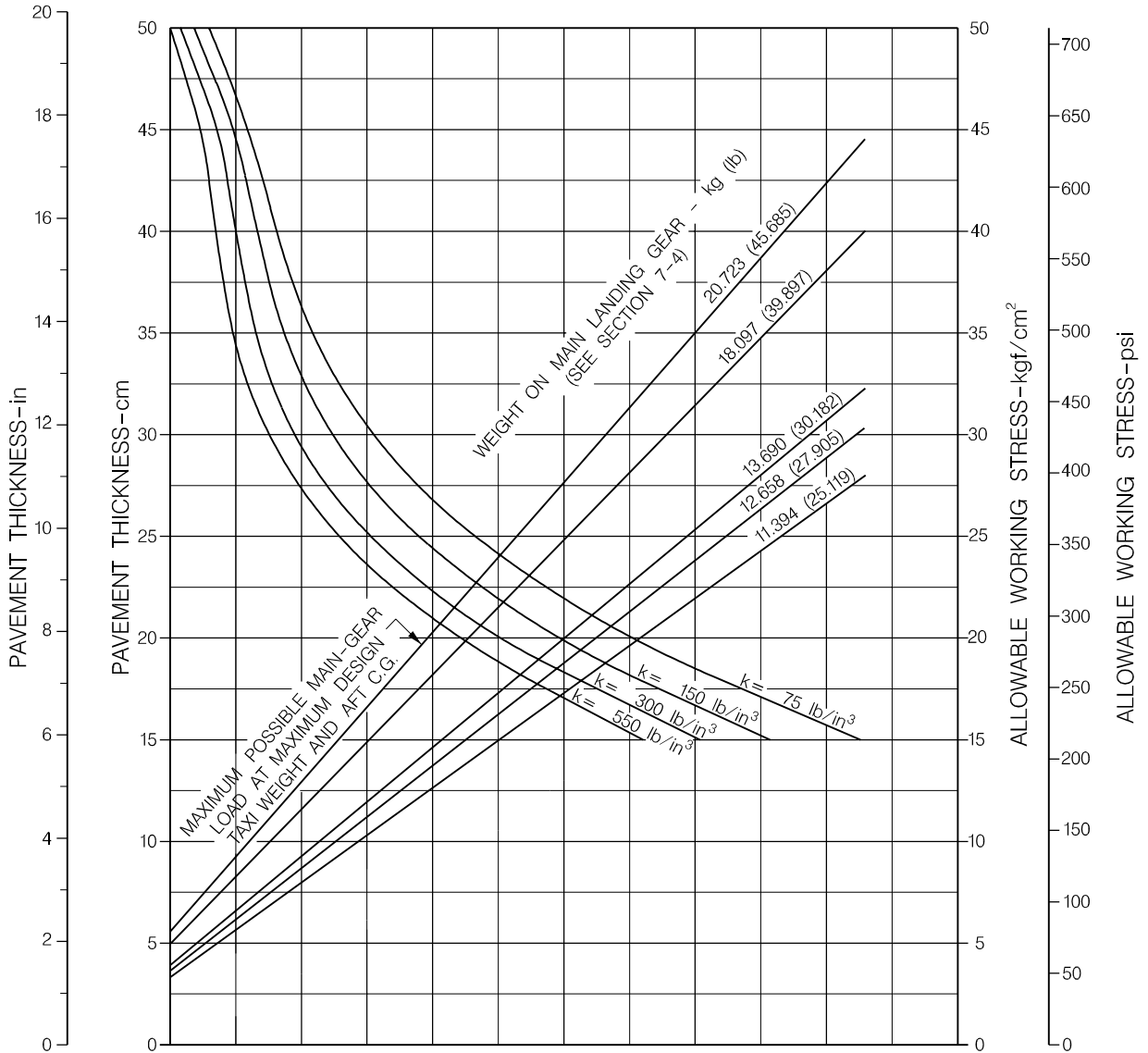
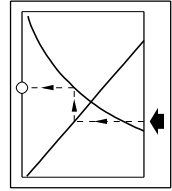
APM070761.MCE A

Figure 7.7.1 - Rigid Pavement Requirements - Portland Cement Association Design Method Sheet 3



RIGID PAVEMENT REQUIREMENTS - MODEL EMB-145 LR/LU

- NOTES:**
- H30 x 9.5-16 16PR TIRES
 - TIRE PRESSURE 11.25 kgf/cm² (160 psi) (LOADED)
 - % WEIGHT ON MAIN GEARS 93.8%

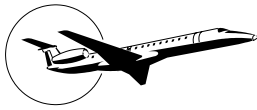


NOTE: THE VALUES OBTAINED BY USING THE MAXIMUM LOAD REFERENCE LINE AND ANY VALUE OF "K" ARE EXACT. FOR LOADS LESS THAN MAXIMUM, THE CURVES ARE EXACT FOR K=300 BUT DEVIATE SLIGHTLY FOR OTHER VALUES OF "K".

REFERENCE: PORTLAND CEMENT ASSOCIATION METHOD.

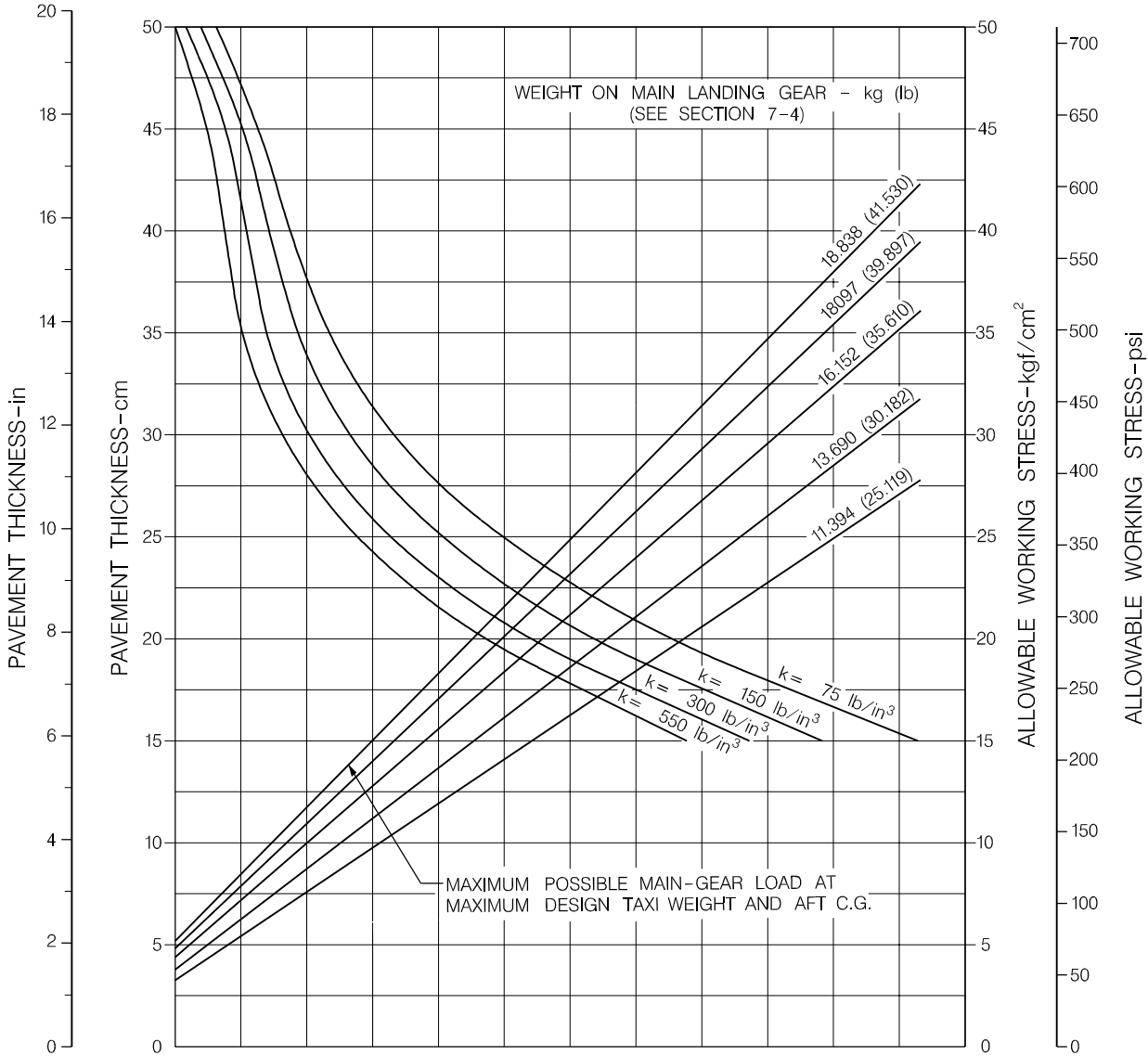
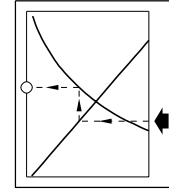
APM070763.MCE A

**Figure 7.7.1 - Rigid Pavement Requirements - Portland Cement Association Design Method
Sheet 4**



RIGID PAVEMENT REQUIREMENTS - MODEL EMB-145 MK

- NOTES:**
- 30 x 9.5-14 16PR TIRES
 - TIRE PRESSURE 10.55 kgf/cm² (150 psi) (LOADED)
 - % WEIGHT ON MAIN GEARS 93.8 %

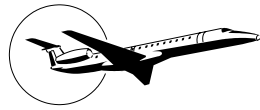


NOTE: THE VALUES OBTAINED BY USING THE MAXIMUM LOAD REFERENCE LINE AND ANY VALUE OF "K" ARE EXACT. FOR LOADS LESS THAN MAXIMUM, THE CURVES ARE EXACT FOR K=300 BUT DEVIATE SLIGHTLY FOR OTHER VALUES OF "K".

REFERENCE: POTLAND CEMENT ASSOCIATION METHOD

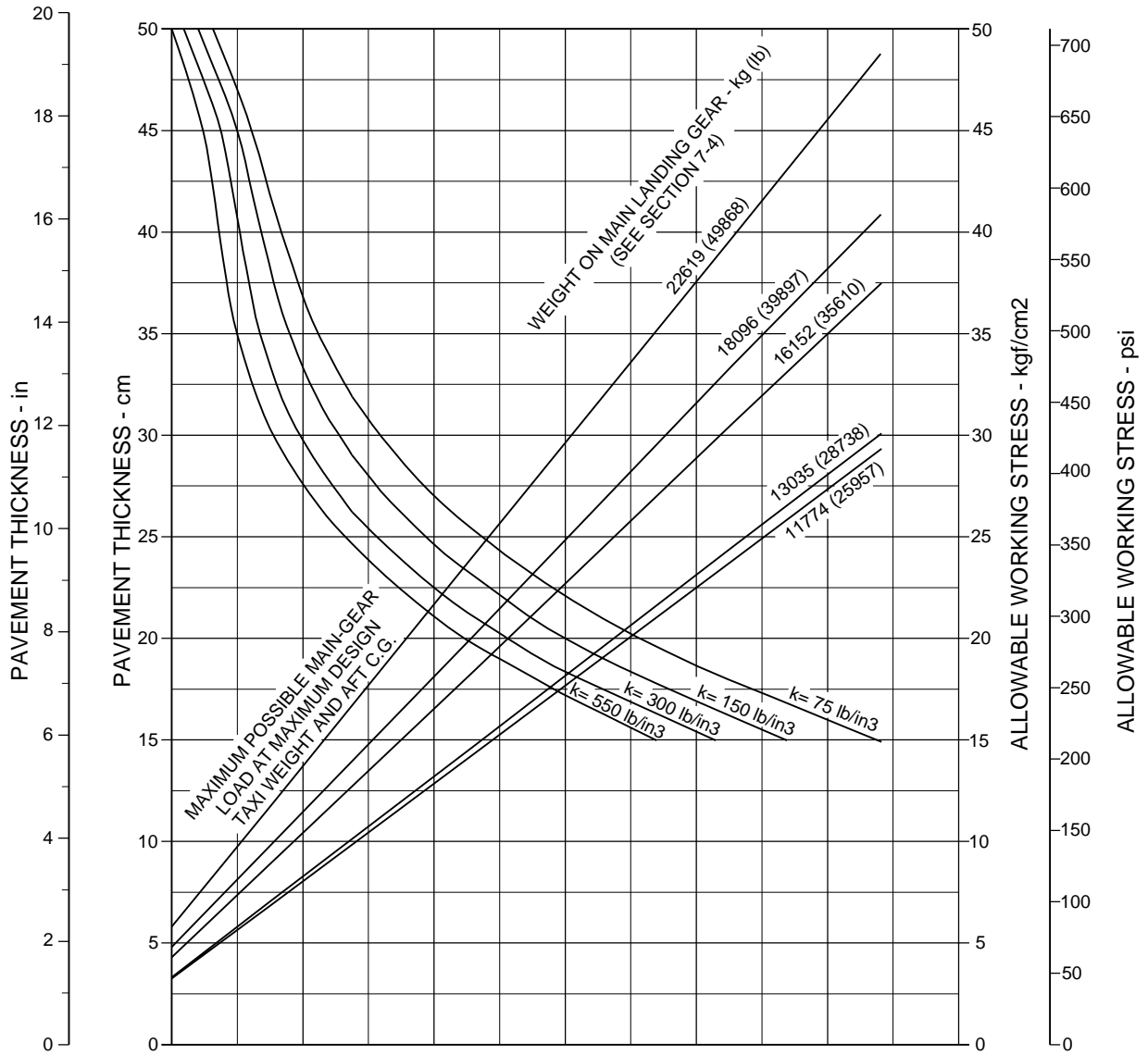
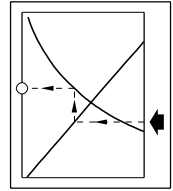
APM070780.MCE

*Figure 7.7.1 - Rigid Pavement Requirements - Portland Cement Association Design Method
Sheet 5*



RIGID PAVEMENT REQUIREMENTS - MODEL EMB-145 XR

- NOTES:**
- 30 x 9.5-16 16PR TIRES
 - TIRE PRESSURE 12.30 kgf/cm² (175 psi) (LOADED)
 - % WEIGHT ON MAIN GEARS 93.47%

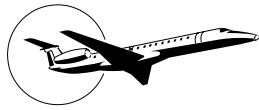


NOTE: THE VALUES OBTAINED BY USING THE MAXIMUM LOAD REFERENCE LINE AND ANY VALUE OF "K" ARE EXACT. FOR LOADS LESS THAN MAXIMUM, THE CURVES ARE EXACT FOR K=300 BUT DEVIATE SLIGHTLY FOR OTHER VALUES OF "K".

REFERENCE: PORTLAND CEMENT ASSOCIATION METHOD.

145APM070817.MCE

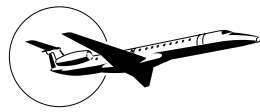
*Figure 7.7.1 - Rigid Pavement Requirements - Portland Cement Association Design Method
Sheet 6*



7.8 Rigid Pavement Requirements - LCN Method

To determine the airplane weight that can be accommodated on a particular rigid airport pavement, both the LCN of the pavement and the radius of relative stiffness must be known.

7.8.1 Radius of Relative Stiffness



RADIUS OF RELATIVE STIFFNESS (L)
VALUES IN INCHES

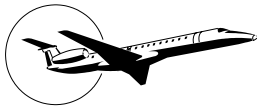
$$L = \sqrt[4]{\frac{Ed^3}{12(1-\mu^2)k}} = 24.1652 \sqrt[4]{\frac{d^3}{k}}$$

WHERE: E = YOUNG'S MODULUS = 4×10^6 psi
 k = SUBGRADE MODULUS, lb/in³
 d = RIGID-PAVEMENT THICKNESS, in.
 μ = POISSON'S RATIO = 0.15

d (in)	k=75	k=100	k=150	k=200	k=250	k=300	k=350	k=400	k=500	k=550
6.0	31.48	29.30	26.47	24.63	23.30	22.26	21.42	20.72	19.59	19.13
6.5	33.43	31.11	28.11	26.16	24.74	23.64	22.74	22.00	20.80	20.31
7.0	35.34	32.89	29.72	27.65	26.15	24.99	24.04	23.25	21.99	21.47
7.5	37.22	34.63	31.29	29.12	27.54	26.32	25.32	24.49	23.16	22.61
8.0	39.06	36.35	32.85	30.57	28.91	27.62	26.58	25.70	24.31	23.74
8.5	40.88	38.04	34.37	31.99	30.25	28.91	27.81	26.90	25.44	24.84
9.0	42.67	39.71	35.88	33.39	31.58	30.17	29.03	28.08	26.55	25.93
9.5	44.43	41.35	37.36	34.77	32.89	31.42	30.23	29.24	27.65	27.00
10.0	46.18	42.97	38.83	36.14	34.17	32.65	31.42	30.39	28.74	28.06
10.5	47.90	44.57	40.28	37.48	35.45	33.87	32.59	31.52	29.81	29.11
11.0	49.60	46.16	41.71	38.81	36.71	35.07	33.75	32.64	30.87	30.14
11.5	51.28	47.72	43.12	40.13	37.95	36.26	34.89	33.74	31.91	31.16
12.0	52.94	49.27	44.52	41.43	39.18	37.44	36.02	34.84	32.95	32.17
12.5	54.59	50.80	45.90	42.72	40.40	38.60	37.14	35.92	33.97	33.17
13.0	56.22	52.32	47.27	43.99	41.61	39.75	38.25	36.99	34.99	34.16
13.5	57.83	53.82	48.63	45.26	42.80	40.89	39.35	38.06	35.99	35.14
14.0	59.43	55.31	49.98	46.51	43.98	42.02	40.44	39.11	36.99	36.12
14.5	61.02	56.78	51.31	47.75	45.16	43.15	41.51	40.15	37.97	37.08
15.0	62.59	58.25	52.63	48.98	46.32	44.26	42.58	41.19	38.95	38.03
15.5	64.15	59.70	53.94	50.20	47.47	45.36	43.64	42.21	39.92	38.98
16.0	65.69	61.13	55.24	51.41	48.62	46.45	44.70	43.23	40.88	39.92
16.5	67.23	62.56	56.53	52.61	49.75	47.54	45.74	44.24	41.84	40.85
17.0	68.75	63.98	57.81	53.80	50.88	48.61	46.77	45.24	42.78	41.78
17.5	70.26	65.38	59.08	54.98	52.00	49.68	47.80	46.23	43.72	42.70
18.0	71.76	66.78	60.34	56.15	53.11	50.74	48.82	47.22	44.66	43.61
18.5	73.25	68.17	61.60	57.32	54.21	51.80	49.84	48.20	45.59	44.51
19.0	74.73	69.54	62.84	58.48	55.31	52.84	50.84	49.17	46.51	45.41
19.5	76.20	70.91	64.08	59.63	56.39	53.88	51.84	50.14	47.42	46.30
20.0	77.66	72.27	65.30	60.77	57.47	54.91	52.84	51.10	48.33	47.19
20.5	79.11	73.62	66.52	61.91	58.55	55.94	53.83	52.06	49.23	48.07
21.0	80.55	74.96	67.74	63.04	59.62	56.96	54.81	53.01	50.13	48.95
21.5	81.99	76.30	68.94	64.16	60.68	57.97	55.78	53.95	51.02	49.82
22.0	83.41	77.63	70.14	65.28	61.73	58.98	56.75	54.89	51.91	50.69
22.5	84.83	78.95	71.34	66.38	62.78	59.99	57.72	55.82	52.79	51.55
23.0	86.24	80.26	72.52	67.49	63.83	60.98	58.68	56.75	53.67	52.41
23.5	87.64	81.56	73.70	68.59	64.86	61.97	59.63	57.67	54.54	53.26
24.0	89.04	82.86	74.87	69.68	65.90	62.96	60.58	58.59	55.41	54.11
24.5	90.43	84.15	76.04	70.76	66.92	63.94	61.52	59.50	56.28	54.95
25.0	91.81	85.44	77.20	71.84	67.95	64.92	62.46	60.41	57.14	55.79

APM070043.MCE A

Figure 7.8.1 - Radius of Relative Stiffness

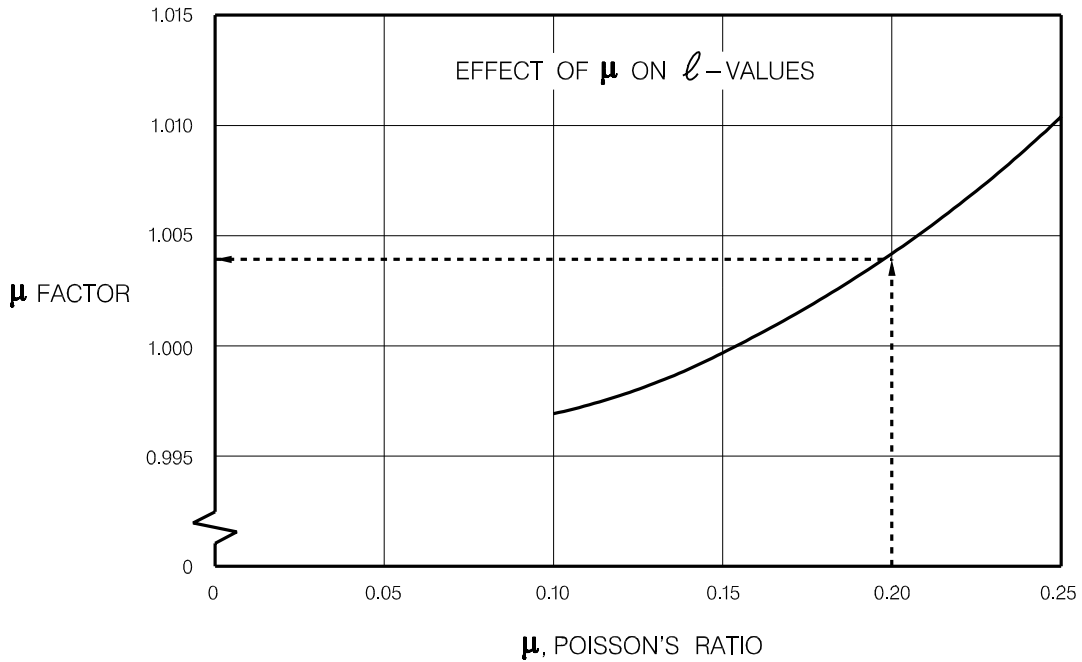
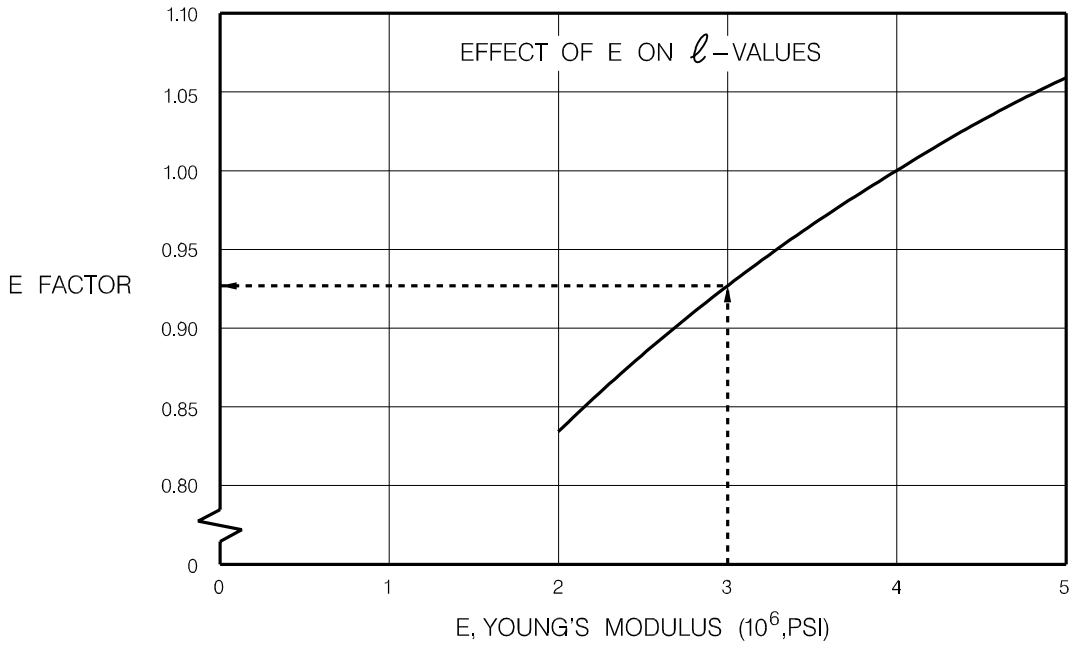
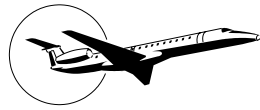


7.8.2 Radius of Relative Stiffness (other values)

The table of section 7.8.1 presents the (RRS) Radius of Relative Stiffness values based on Young's modulus (E) of 4,000,000 psi and Poisson's ratio (μ) of 0.15.

For convenience in finding this Radius based on other values of E and μ , the curves of section 7.8.2 are included.

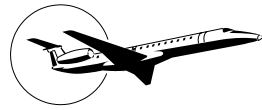
For example, to find an RRS value based on an E of 3,000,000 psi, the "E" factor of 0.931 is multiplied by the RRS value found in figure 7.8.1. The effect of the variations of μ on the RRS value is treated in a similar manner.



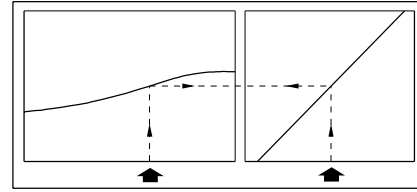
NOTE: BOTH CURVES ON THIS PAGE ARE USED TO ADJUST THE ℓ -VALUES.

145AP027.MCE

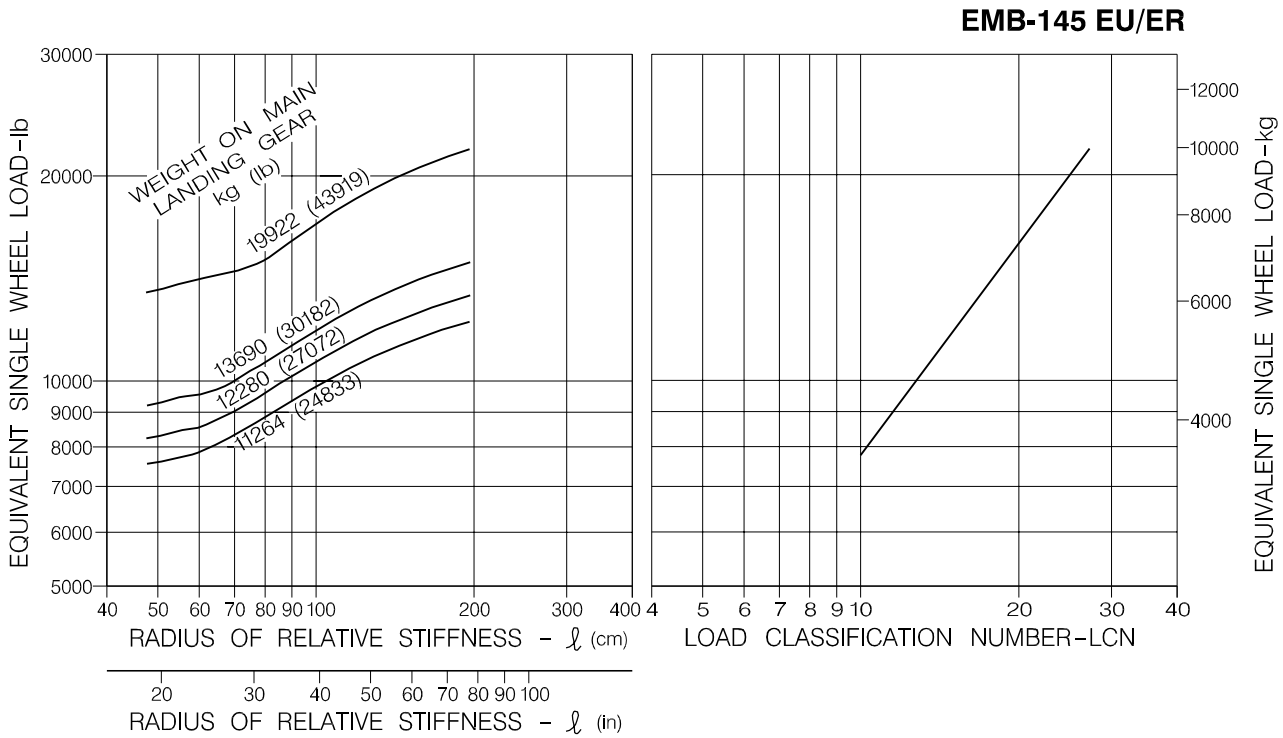
Figure 7.8.2 - Radius of Relative Stiffness (other values)



7.8.3 Rigid Pavement Requirements - LCN Method



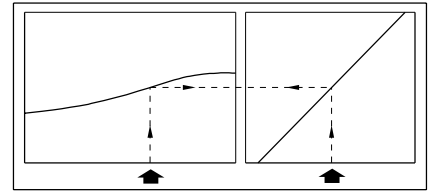
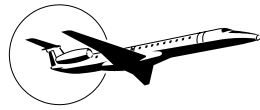
TIRES 30x9.5-14 16PR AT 10.19 kgf/cm² (145psi)



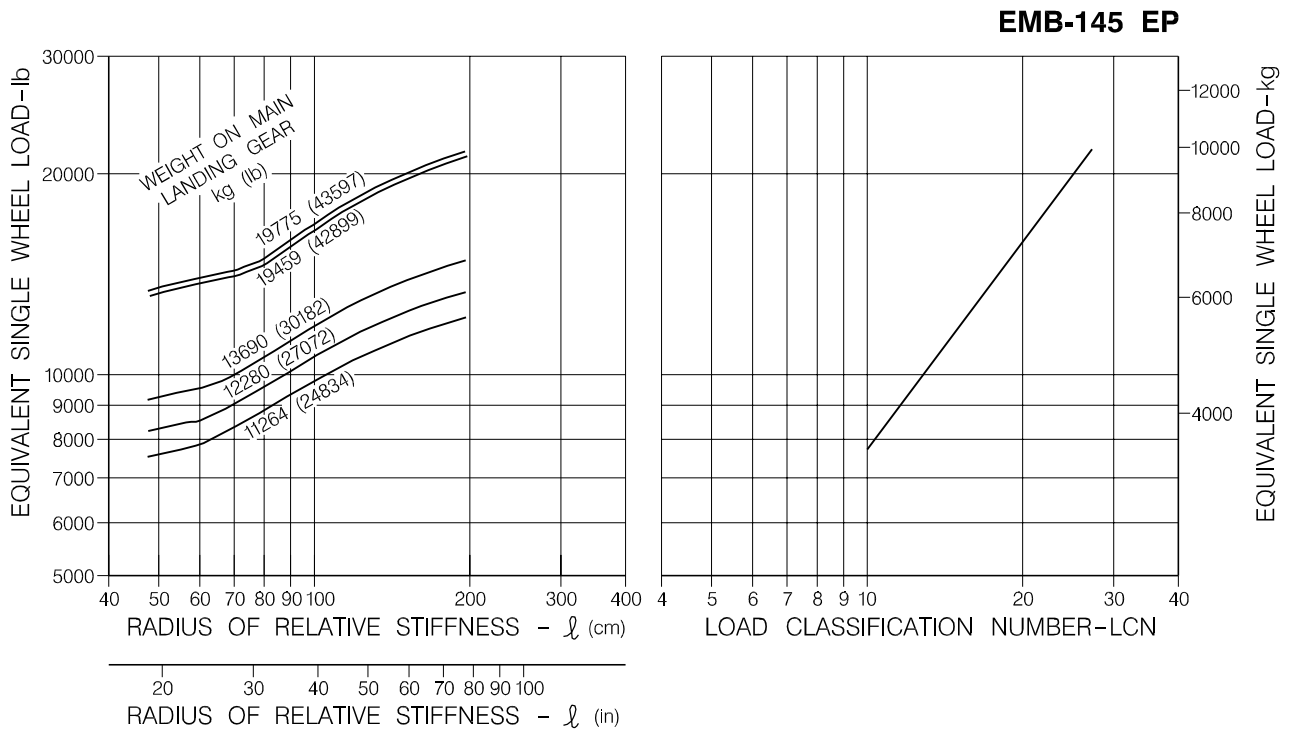
NOTE: EQUIVALENT SINGLE WHEEL LOADS ARE DERIVED BY METHODS SHOWN IN ICAO AERODROME MANUAL, PART 2, PAR. 4.1.3

APM070769.MCE A

*Figure 7.8.3 - Rigid Pavement Requirements - LCN Method
Sheet 1*



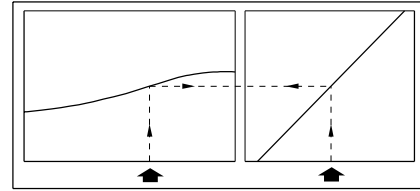
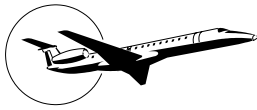
TIRES 30x9.5-14 16PR AT 10.41 kgf/cm² (148psi)



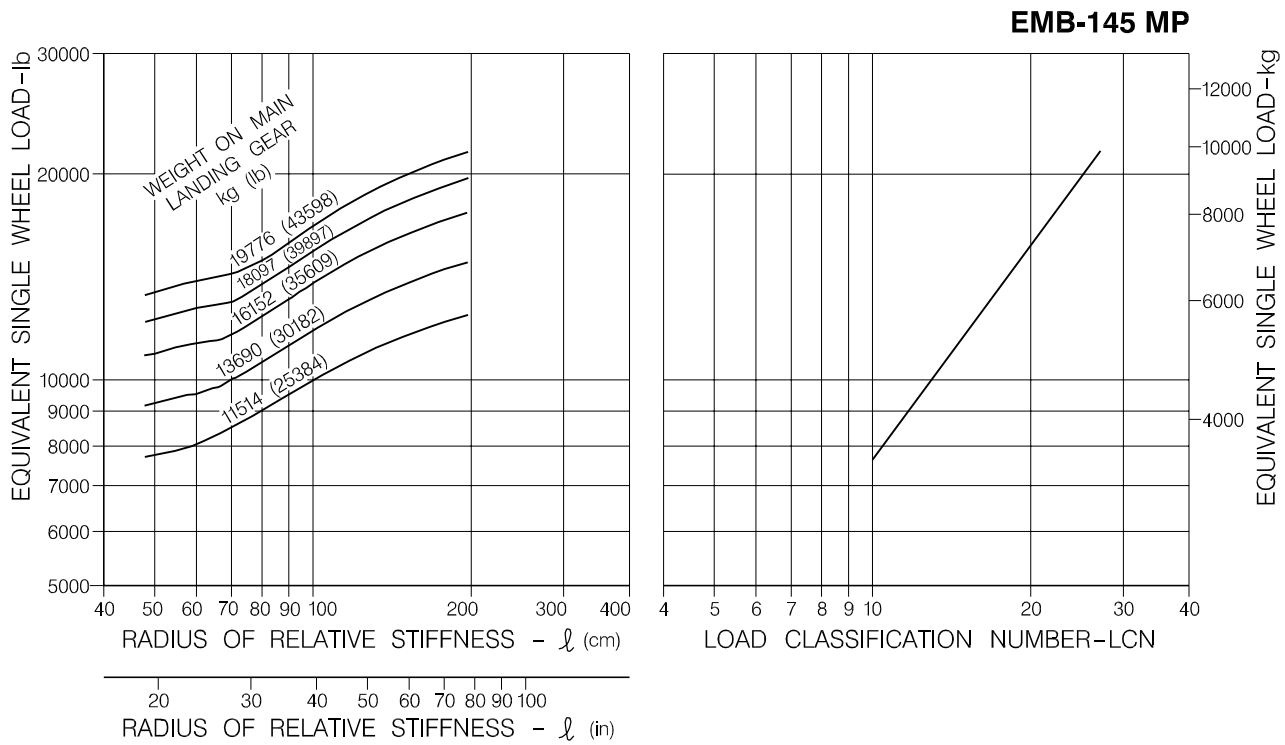
NOTE: EQUIVALENT SINGLE WHEEL LOADS ARE DERIVED BY METHODS SHOWN IN ICAO AERODROME MANUAL, PART 2, PAR. 4.1.3

APM070058.MCE B

*Figure 7.8.3 - Rigid Pavement Requirements - LCN Method
Sheet 2*



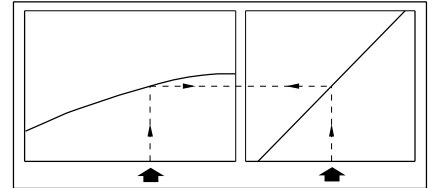
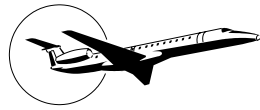
TIRES 30x9.5-14 16PR AT 10.55 kgf/cm² (150psi)



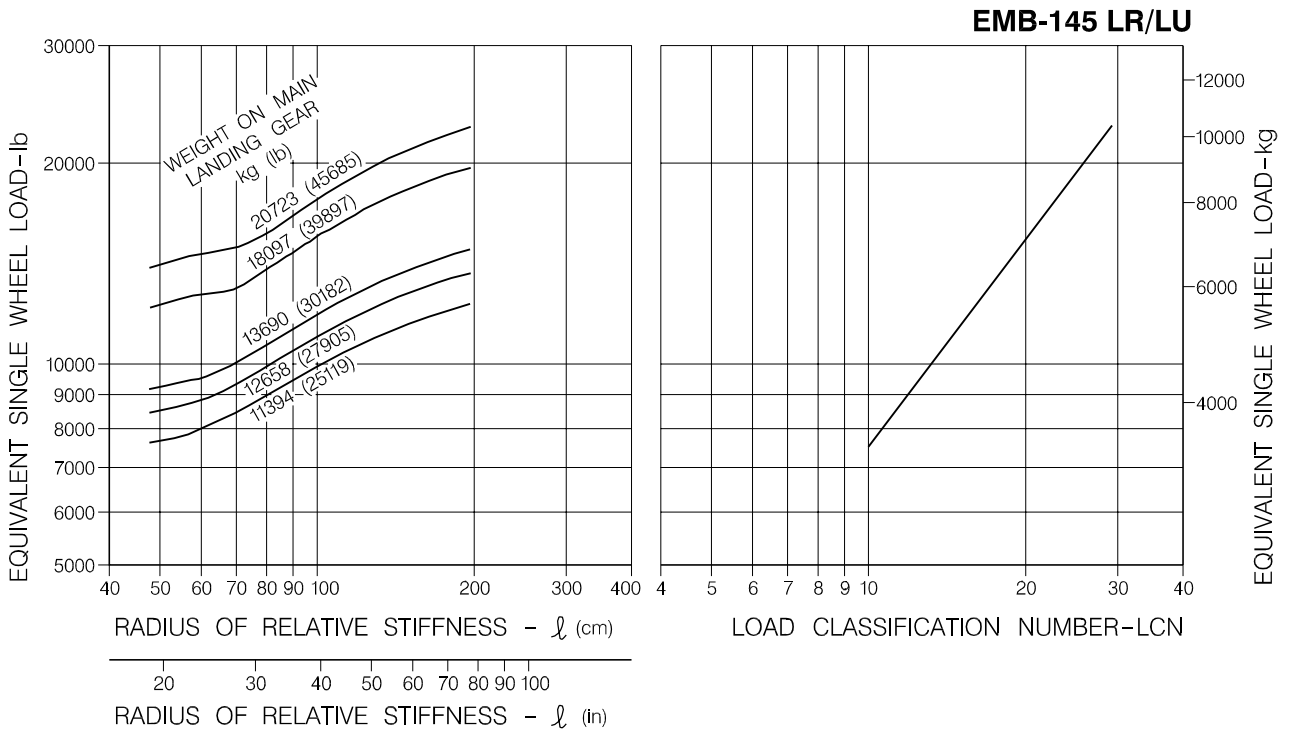
NOTE: EQUIVALENT SINGLE WHEEL LOADS ARE DERIVED BY METHODS SHOWN IN ICAO AERODROME MANUAL. PART 2, PAR. 4.1.3

APM070770.MCE A

*Figure 7.8.3 - Rigid Pavement Requirements - LCN Method
Sheet 3*



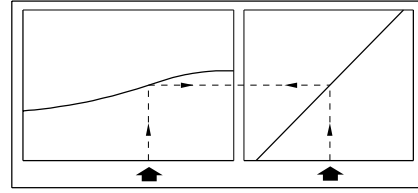
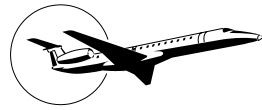
TIRES H30X9.5-14 16PR AT 11.25 kgf/cm² (160psi)



NOTE: EQUIVALENT SINGLE WHEEL LOADS ARE DERIVED BY METHODS SHOWN IN ICAO AERODROME MANUAL, PART 2, PAR. 4.1.3

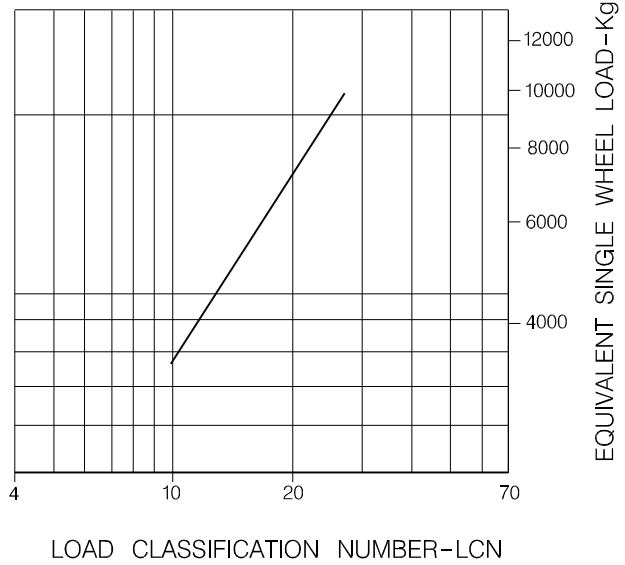
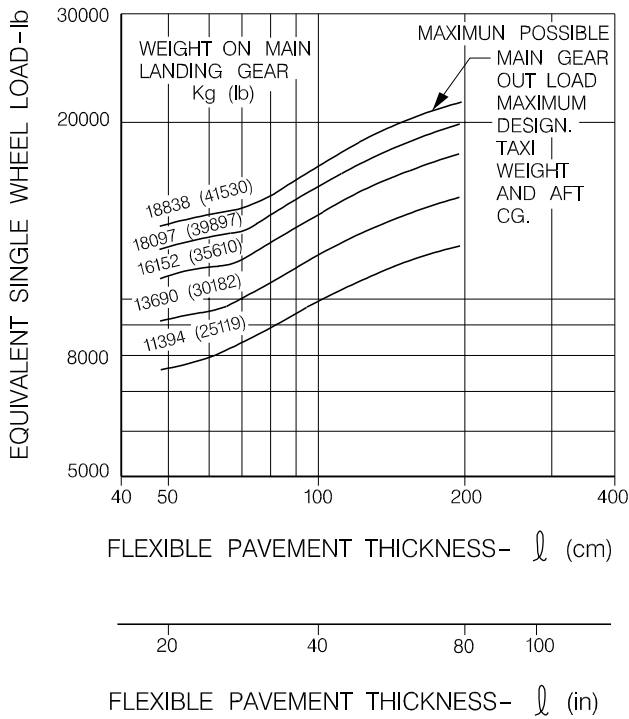
APM070768.MCE A

*Figure 7.8.3 - Rigid Pavement Requirements - LCN Method
Sheet 4*



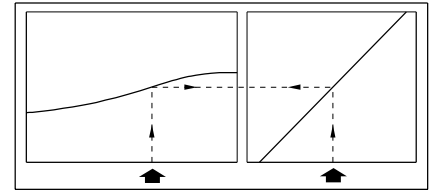
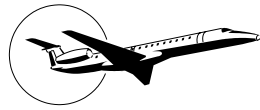
TIRES 30 x 9.5 -14 16PR AT 10,55 Kgf/cm (150 psi)

EMB-145 MK

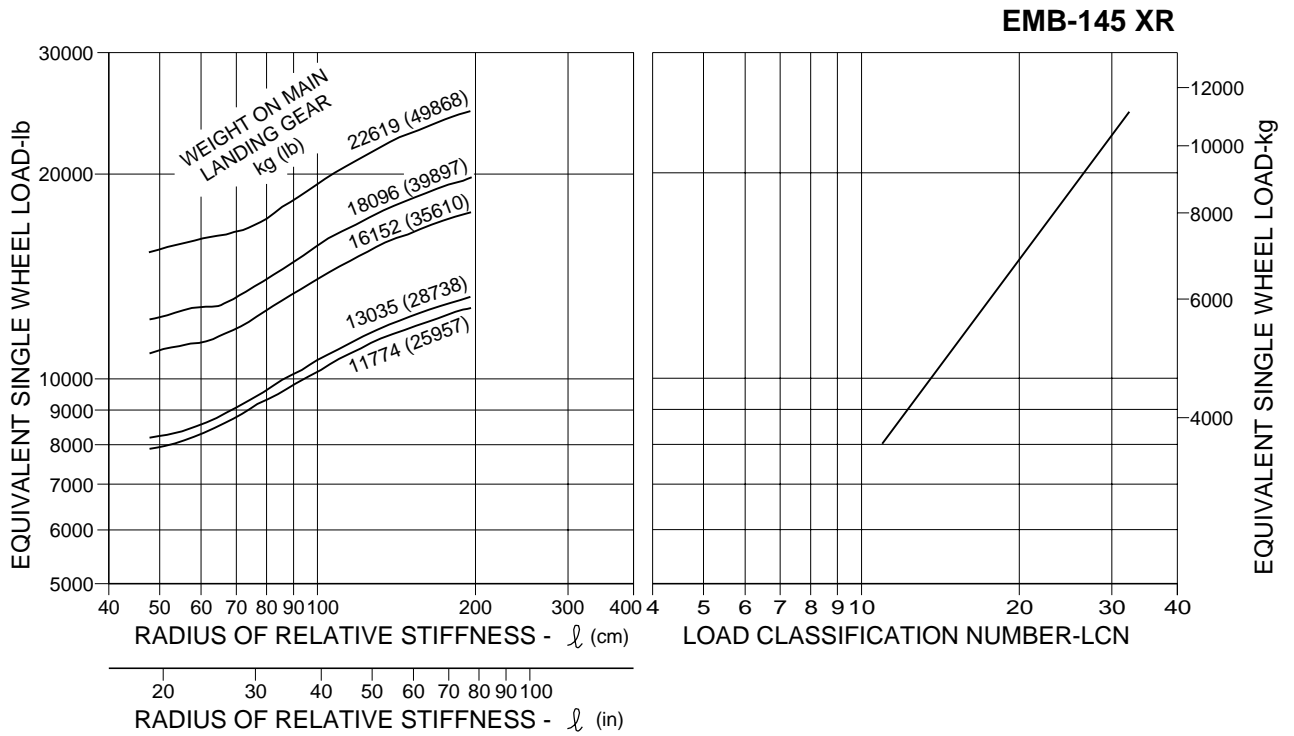


APM070779.MCE

*Figure 7.8.3 - Rigid Pavement Requirements - LCN Method
Sheet 5*



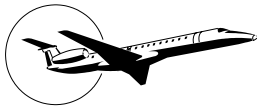
TIRES H 30x9.5-16 16PR AT 12.30 kgf/cm2 (175psi)



NOTE: EQUIVALENT SINGLE WHEEL LOADS ARE DERIVED BY METHODS SHOWN IN ICAO AERODROME MANUAL, PART 2, PAR. 4.1.3

145APM070818.MCE

Figure 7.8.3 - Rigid Pavement Requirements - LCN Method
Sheet 6

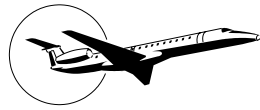


7.9 ACN/PCN Reporting System - Flexible and Rigid Pavements

To determine the ACN of an aircraft on flexible or rigid pavement, both the aircraft gross weight and the subgrade strength must be known. As an example, for an aircraft gross weight of 45,635 lb (EMB-145 ER) and High subgrade strength, the ACN for rigid pavement is 12.2. For the same gross weight and Low subgrade strength, the ACN for rigid pavement is 13.6.

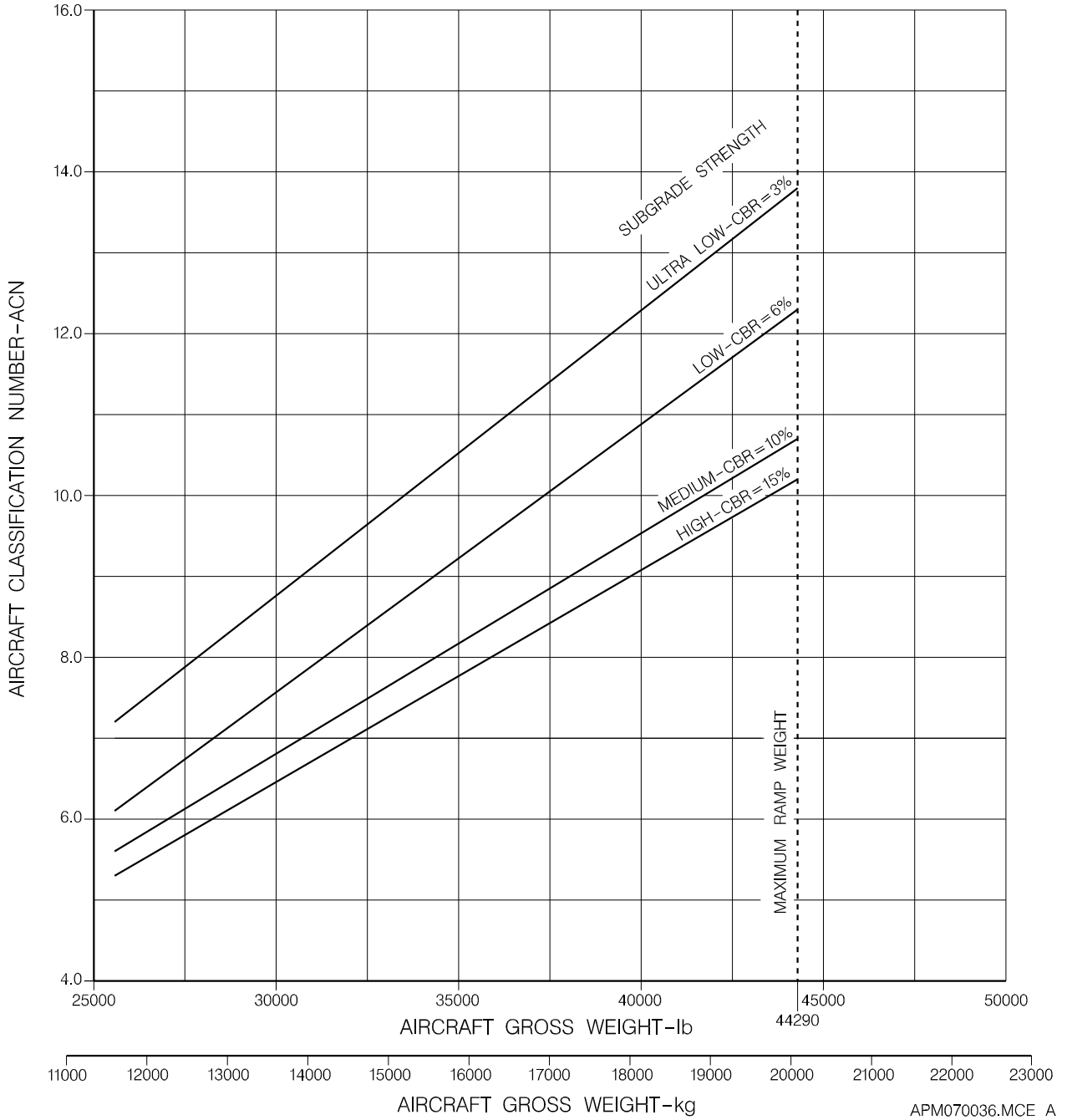
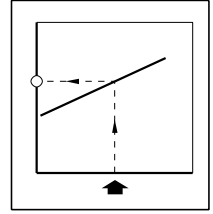
NOTE: An aircraft with an ACN equal to or less than the reported PCN can operate on the pavement subject to any limitations on the tire pressure.

7.9.1 Aircraft Classification Number Flexible Pavement

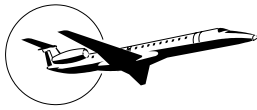


FLEXIBLE PAVEMENT SUBGRADES - MODEL EMB-145 EU

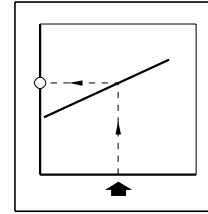
- NOTES:**
- 30 x 9.5-14 16PR TIRES
 - TIRE PRESSURE 9,77 Kg/cm² (139 psi)
 - % WEIGHT ON MAIN GEARS 94.4



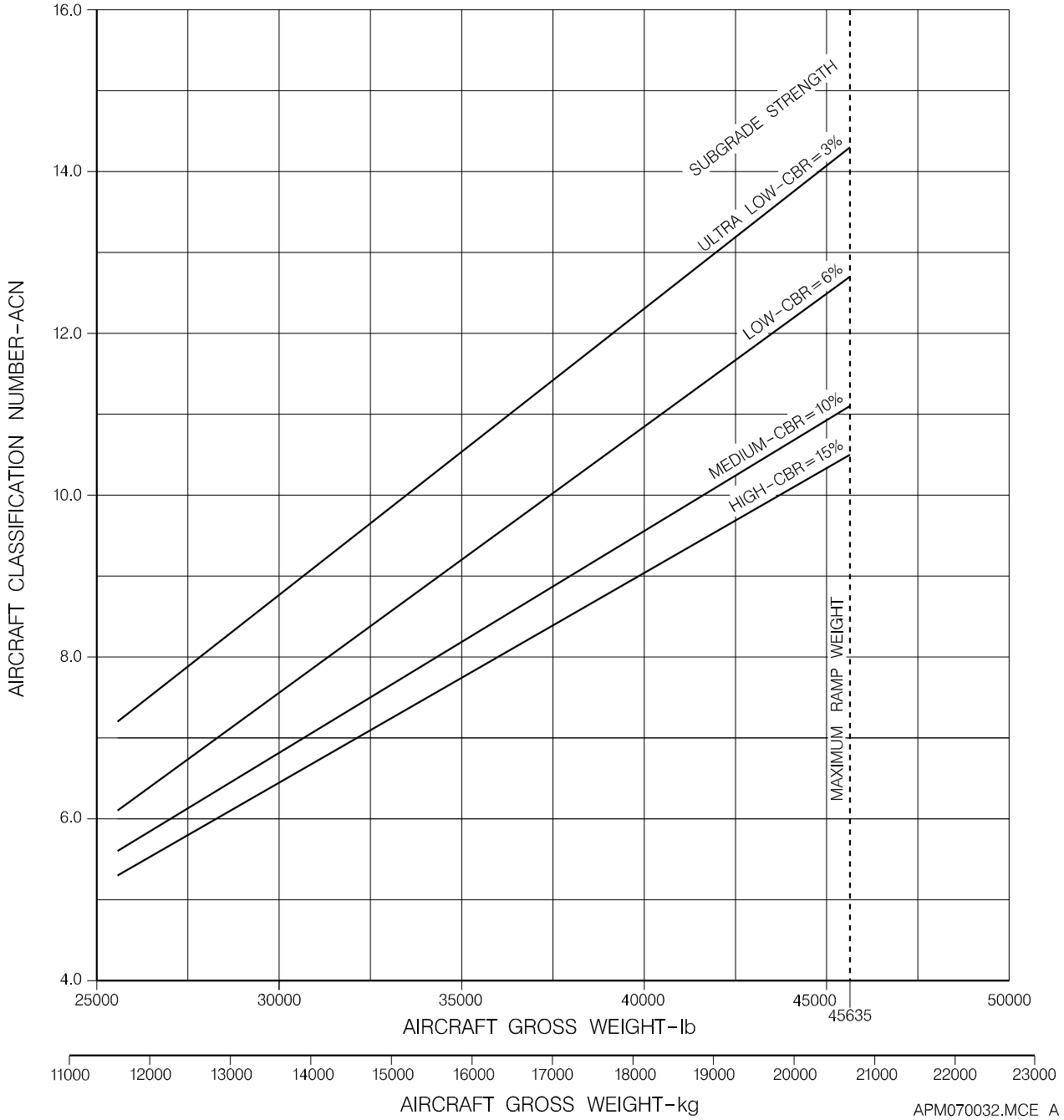
*Figure 7.9.1 - Aircraft Classification Number Flexible Pavement
Sheet 1*



FLEXIBLE PAVEMENT SUBGRADES - MODEL EMB-145 ER

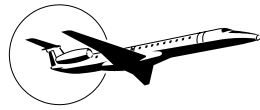


- NOTES:**
- 30 x 9.5-14 16PR TIRES
 - TIRE PRESSURE 9,77Kg/cm² (139 psi)
 - % WEIGHT ON MAIN GEARS 94.4



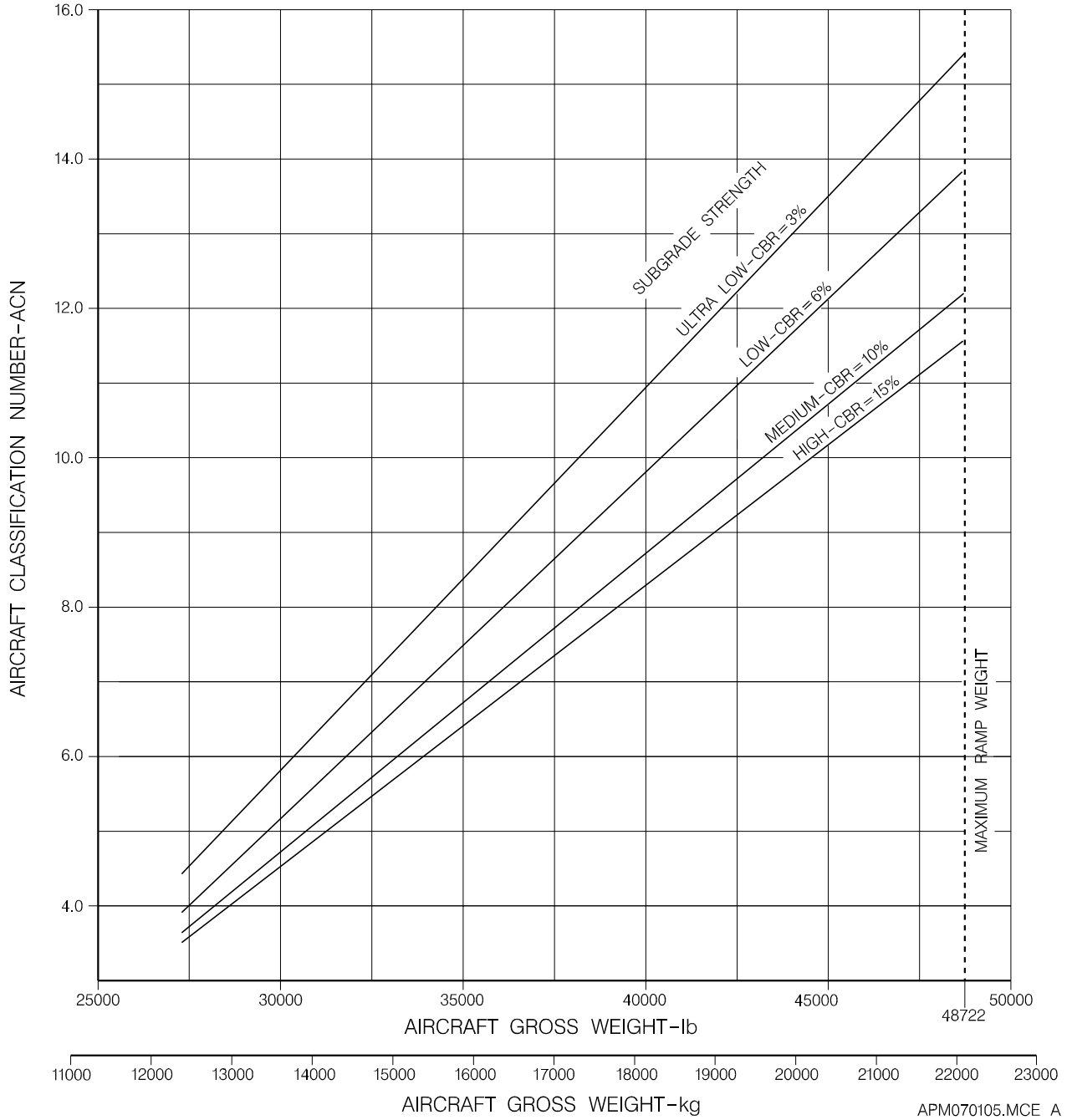
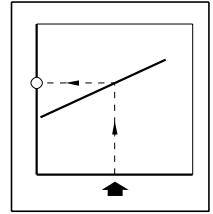
*Figure 7.9.1 - Aircraft Classification Number Flexible Pavement
Sheet 2*

APM070032.MCE A



FLEXIBLE PAVEMENT SUBGRADES - MODEL EMB-145 LR

- NOTES:**
- 30 x 9.5-14 16 TIRES
 - TIRE PRESSURE 10,55 Kgf/cm² (150 psi)
 - % WEIGHT ON MAIN GEARS 93.8%

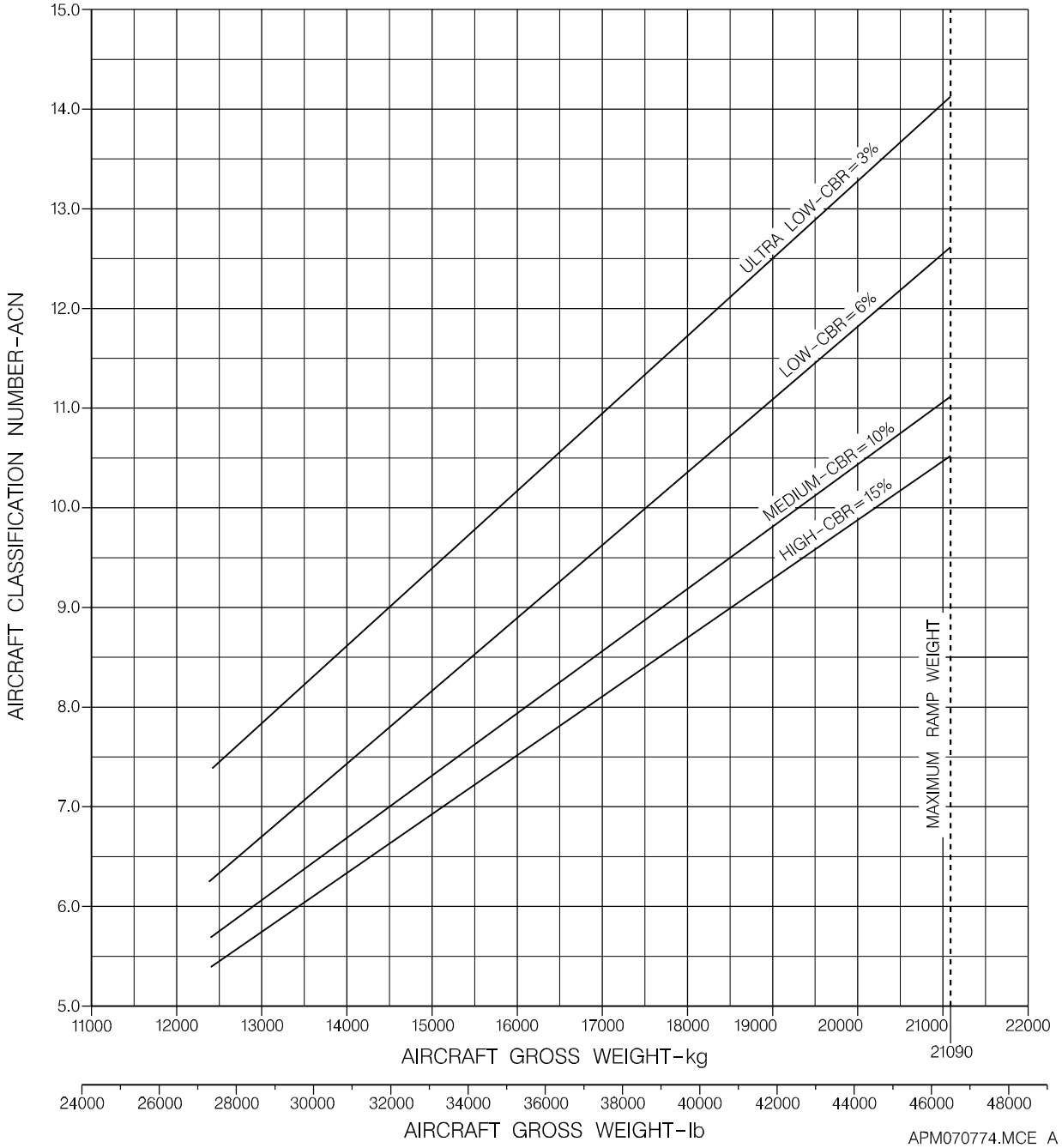
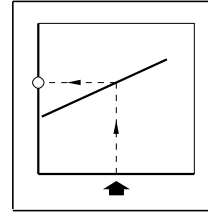


*Figure 7.9.1 - Aircraft Classification Number Flexible Pavement
Sheet 3*

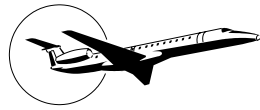


FLEXIBLE PAVEMENT SUBGRADES - MODEL EMB-145 MP

- NOTES:**
- 30 x 9,5-14 16PR TIRES
 - TIRE PRESSURE 10,36 kgf/cm² (147psi) (LOADED)
 - % WEIGHT ON MAIN GEARS 93.8%

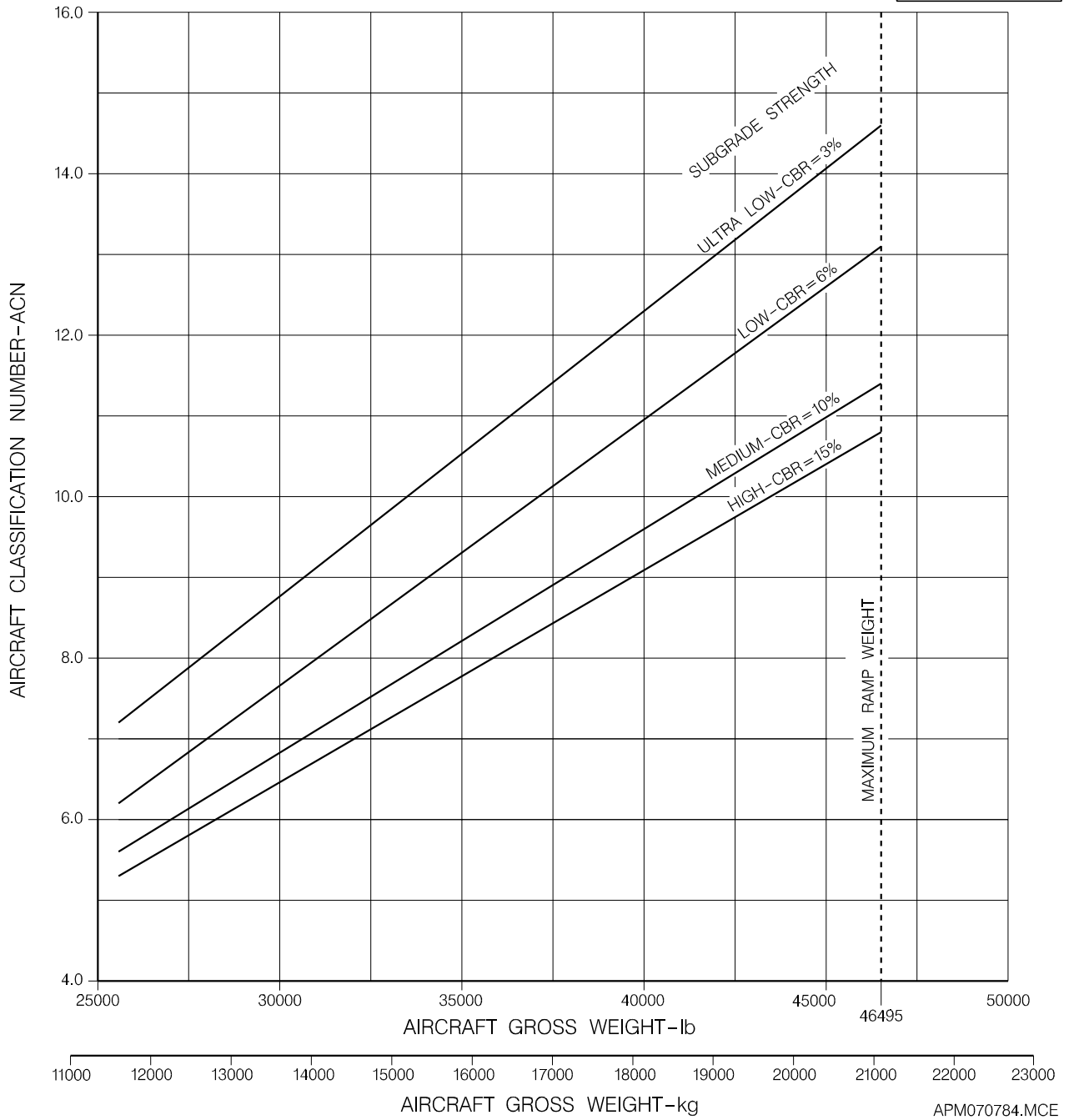
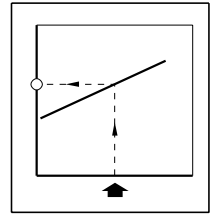


*Figure 7.9.1 - Aircraft Classification Number Flexible Pavement
Sheet 4*



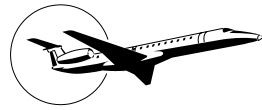
FLEXIBLE PAVEMENT SUBGRADES - MODEL EMB-145 EP

- NOTES:**
- 30 x 9.5-14-16PR TIRES
 - TIRE PRESSURE 9.98kgf/cm (142 psi)
 - % WEIGHT ON MAIN GEARS 94.4%



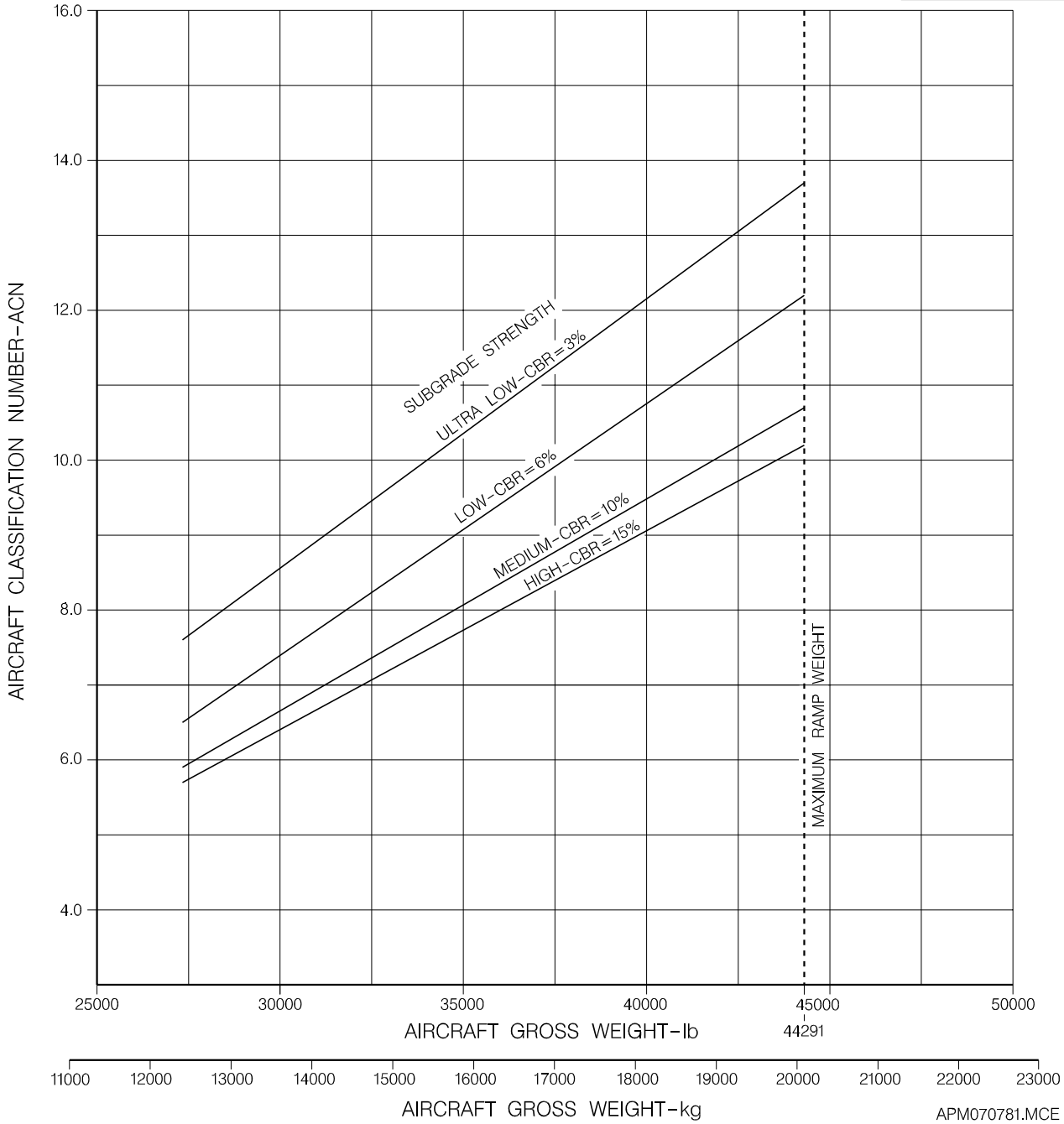
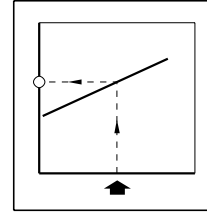
*Figure 7.9.1 - Aircraft Classification Number Flexible Pavement
Sheet 5*

APM070784.MCE

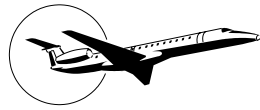


FLEXIBLE PAVEMENT SUBGRADES - MODEL EMB-145 MK

- NOTES:**
- 30 x 9.5-14-16PR TIRES
 - TIRE PRESSURE 10.34kgf/cm (150 psi) (LOADED)
 - % WEIGHT ON MAIN GEARS 93.8%

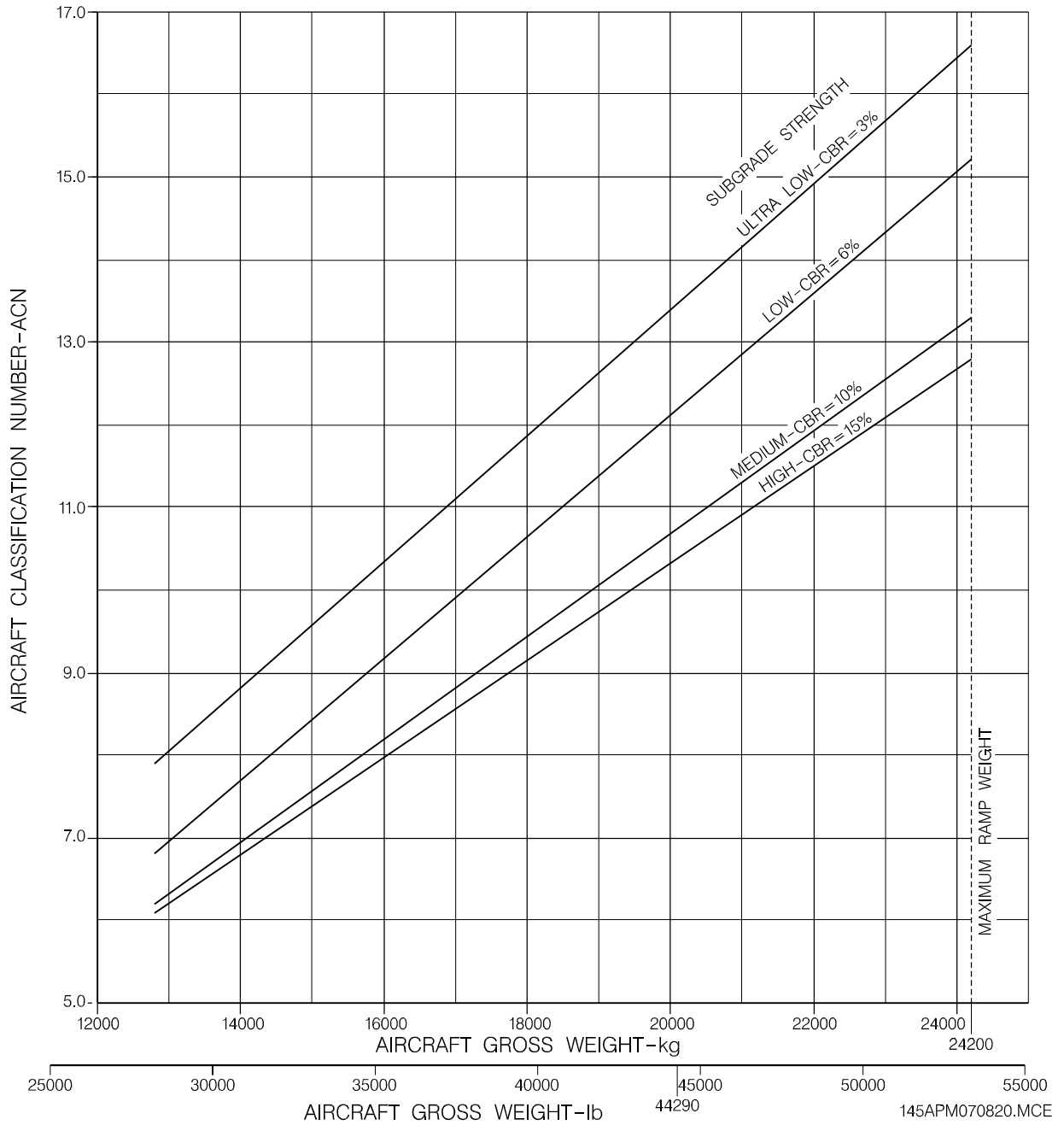
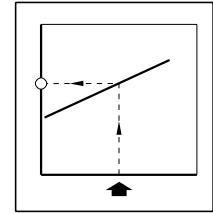


*Figure 7.9.1 - Aircraft Classification Number Flexible Pavement
Sheet 6*

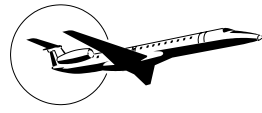


FLEXIBLE PAVEMENT SUBGRADE STRENGTH EMB-145 XR

- NOTES:**
- H30 x 9.5-16 16PR TIRES
 - TIRE PRESSURE 12.30 Kg/cm² (175 psi)
 - % WEIGHT ON MAIN GEARS 93.47



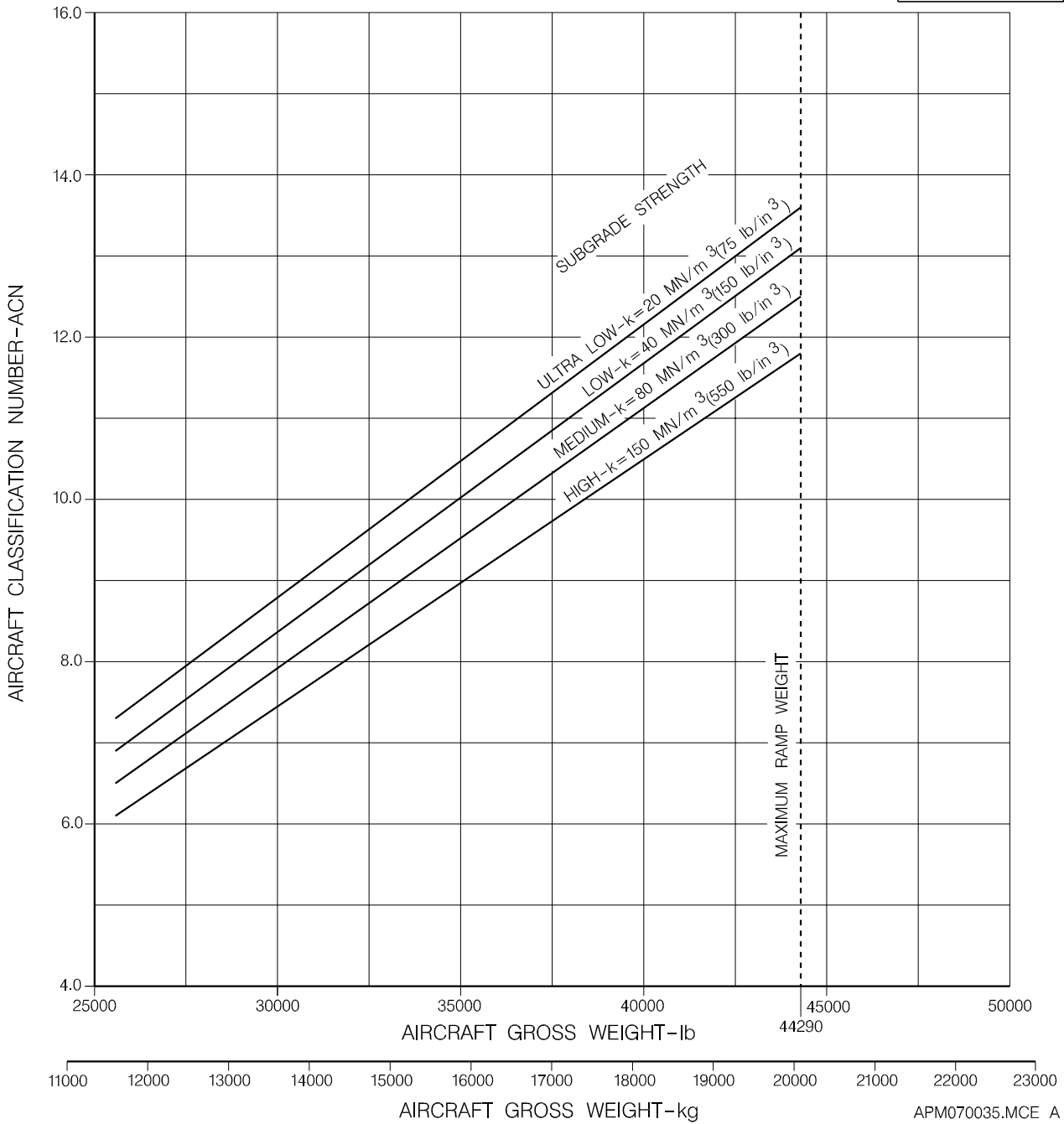
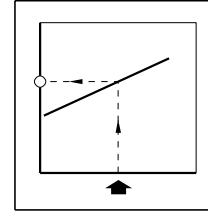
*Figure 7.9.1 - Aircraft Classification Number Flexible Pavement
Sheet 7*



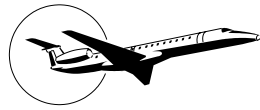
7.9.2 Aircraft Classification Number Rigid Pavement

RIGID PAVEMENT SUBGRADES - MODEL EMB -145 EU

- NOTES:**
- 30 x 9.5-14 16PR TIRES
 - TIRE PRESSURE 9,77Kg/cm² (139 psi)
 - % WEIGHT ON MAIN GEARS 94.4

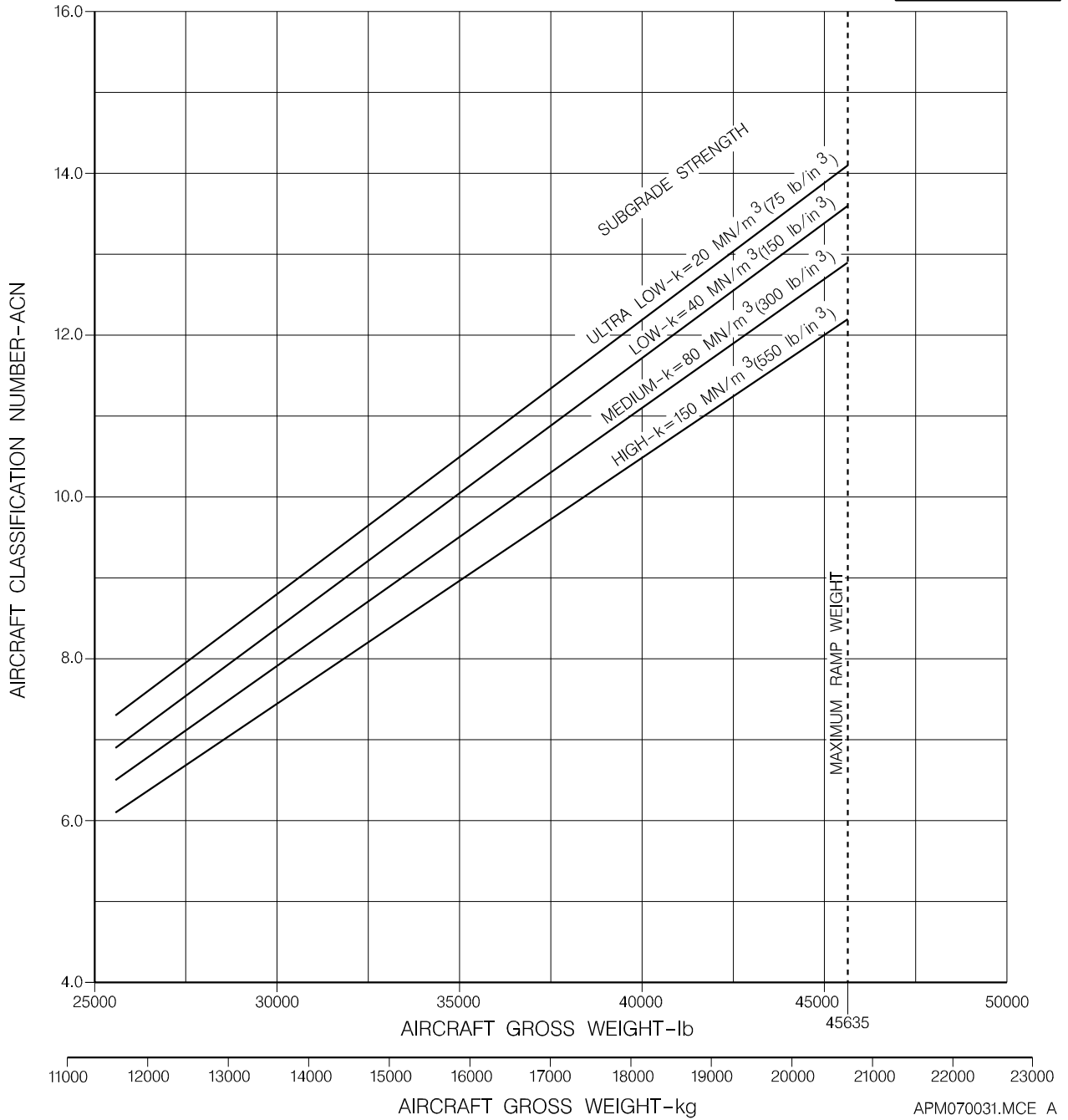
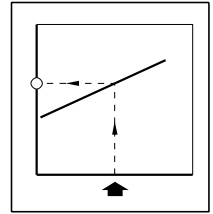


*Figure 7.9.2 - Aircraft Classification Number Rigid Pavement
Sheet 1*

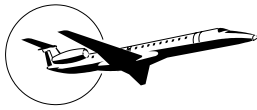


RIGID PAVEMENT SUBGRADES - MODEL EMB-145 ER

- NOTES:**
- 30 x 9.5-14 16PR TIRES
 - TIRE PRESSURE 9,77Kg/cm² (139 psi)
 - % WEIGHT ON MAIN GEARS 94.4

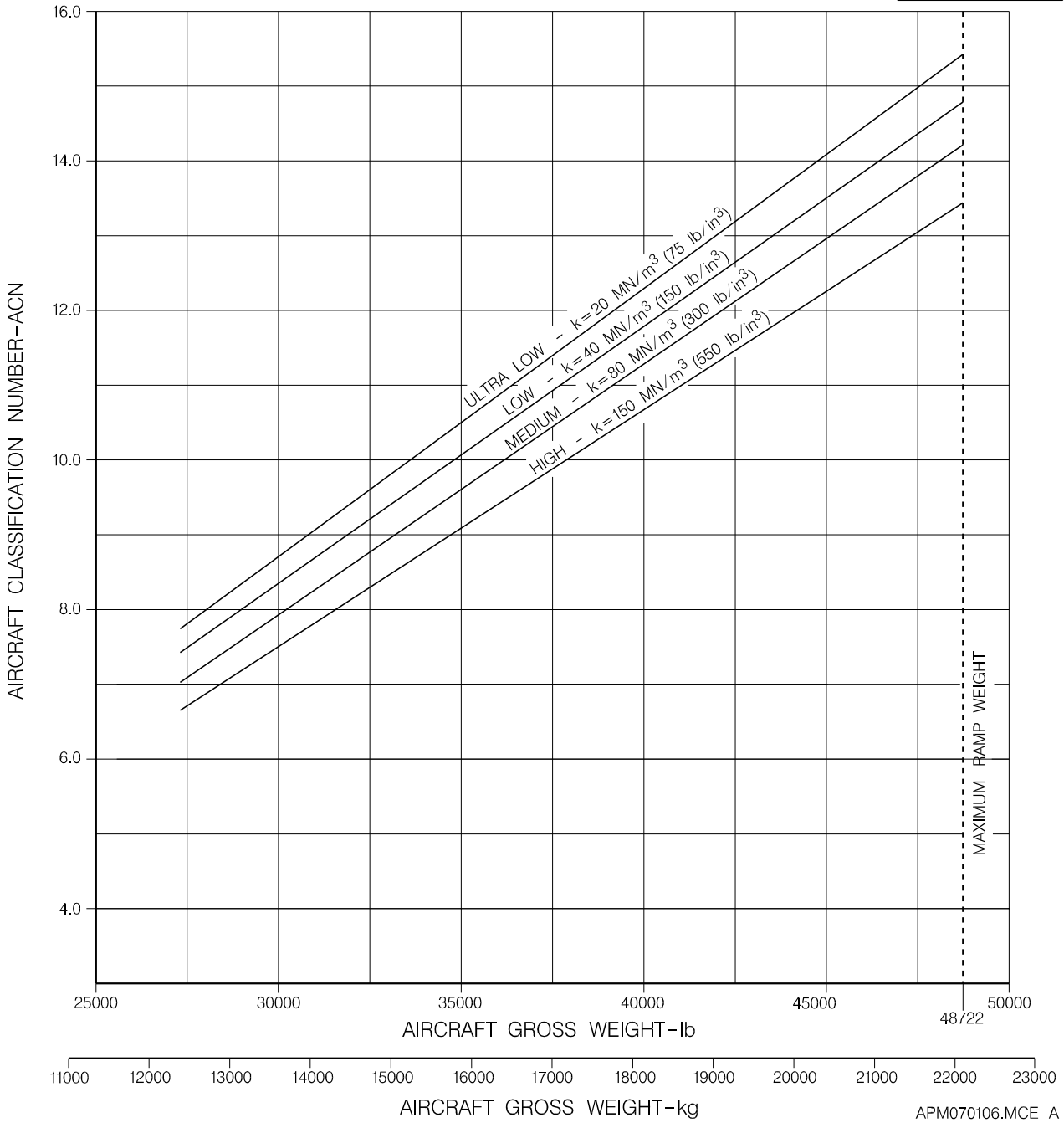
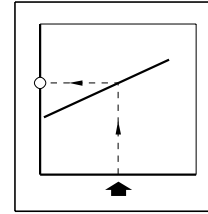


*Figure 7.9.2 - Aircraft Classification Number Rigid Pavement
Sheet 2*

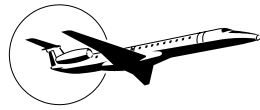


RIGID PAVEMENT SUBGRADES - MODEL EMB-145 LR

- NOTES:**
- 30 x 9.5-14 16 TIRES
 - TIRE PRESSURE 10,55Kgf/cm² (150 psi)
 - % WEIGHT ON MAIN GEARS 93.8%

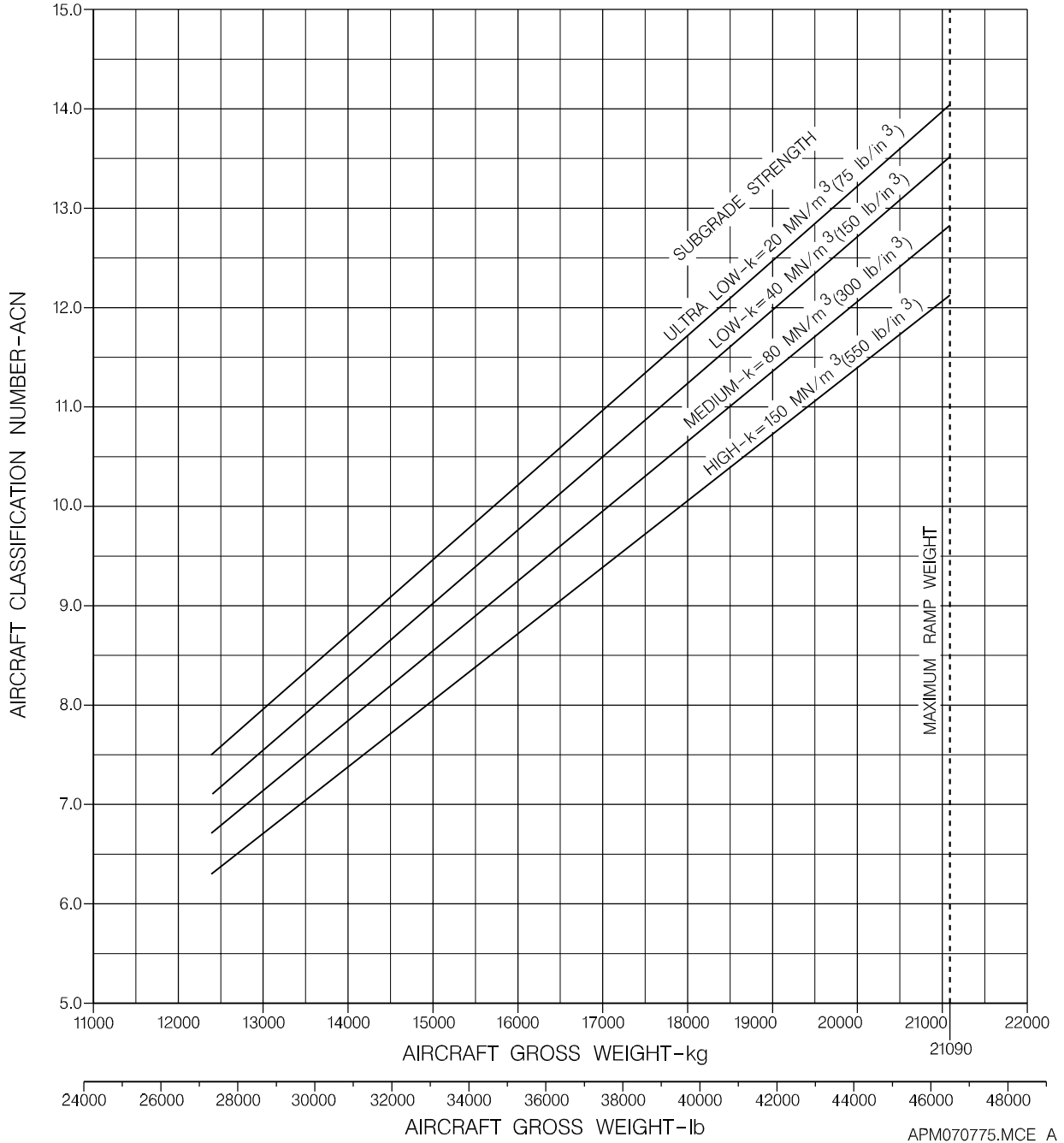
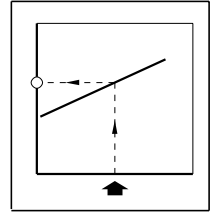


*Figure 7.9.2 - Aircraft Classification Number Rigid Pavement
Sheet 3*



RIGID PAVEMENT SUBGRADES - MODEL EMB -145 MP

- NOTES:**
- 30 x 9.5-14 16PR TIRES
 - TIRE PRESSURE 10.36 kgf/cm² (147psi) (LOADED)
 - % WEIGHT ON MAIN GEARS 93.8%

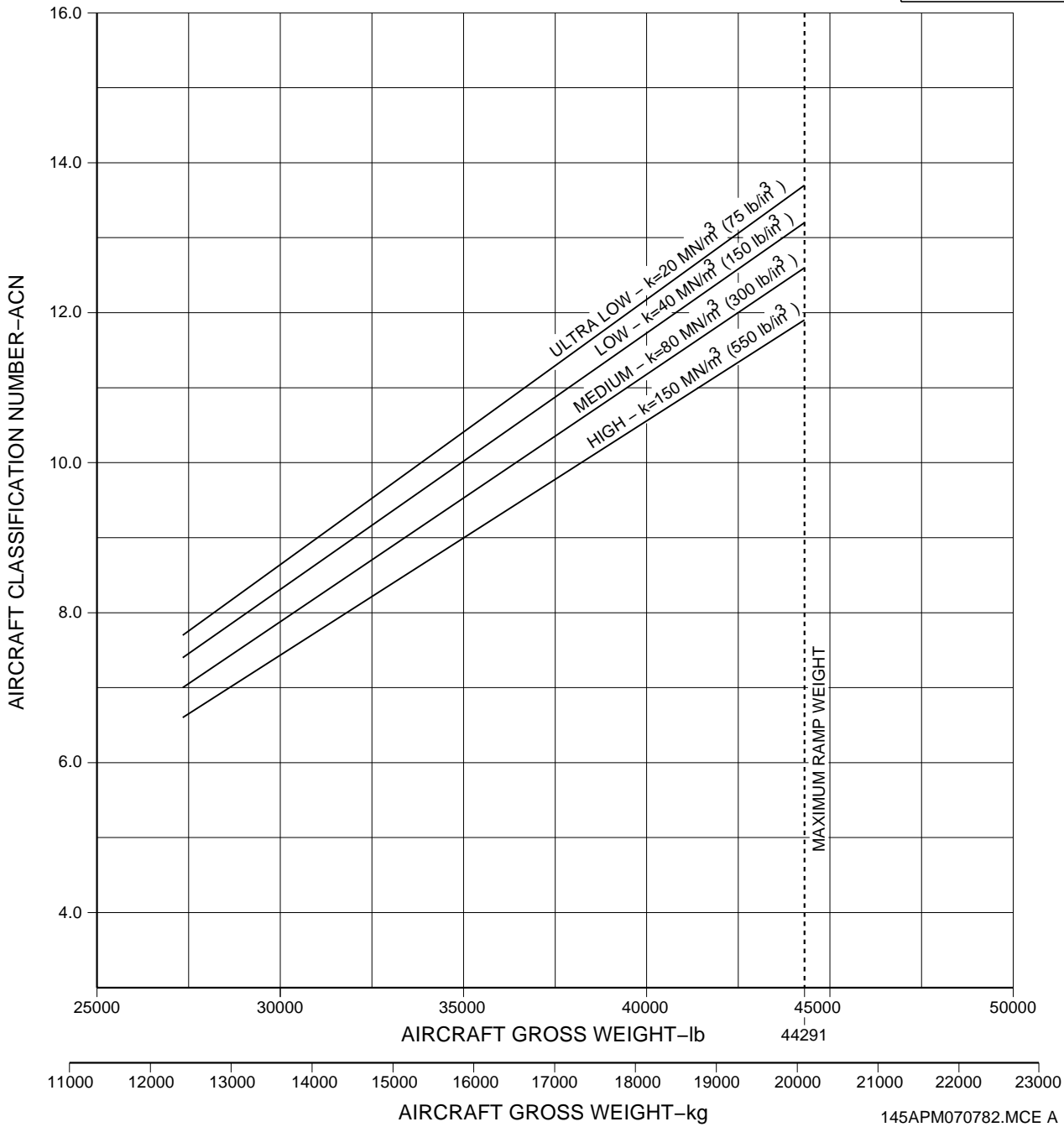
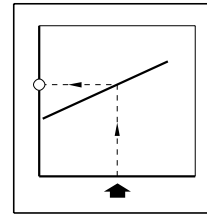


*Figure 7.9.2 - Aircraft Classification Number Rigid Pavement
Sheet 4*

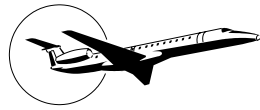


RIGID PAVEMENT SUBGRADES – MODEL EMB-145 MK

- NOTES:**
- 30 x 9.5-14-16PR TIRES
 - TIRE PRESSURE 10.34kgf/cm (150 psi) (LOADED)
 - % WEIGHT ON MAIN GEARS 93.8%

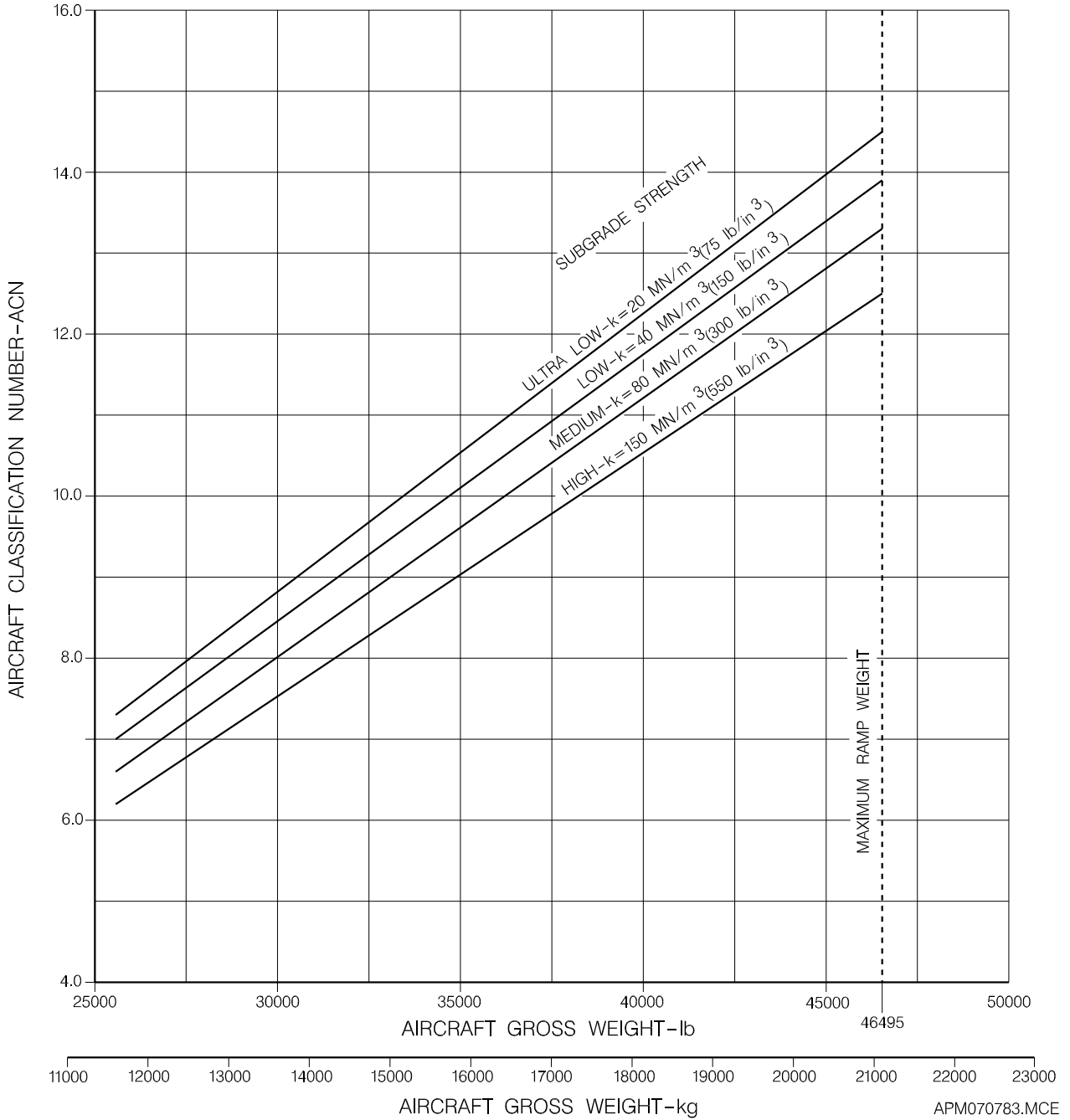
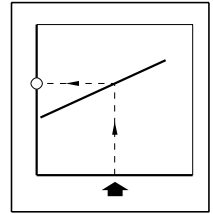


*Figure 7.9.2 - Aircraft Classification Number Rigid Pavement
Sheet 5*

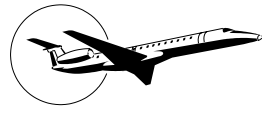


RIGID PAVEMENT SUBGRADES - MODEL EMB -145 EP

- NOTES:**
- 30 x 9.5-14-16PR TIRES
 - TIRE PRESSURE 9.98kgf/cm (142 psi)
 - % WEIGHT ON MAIN GEARS 94.4%

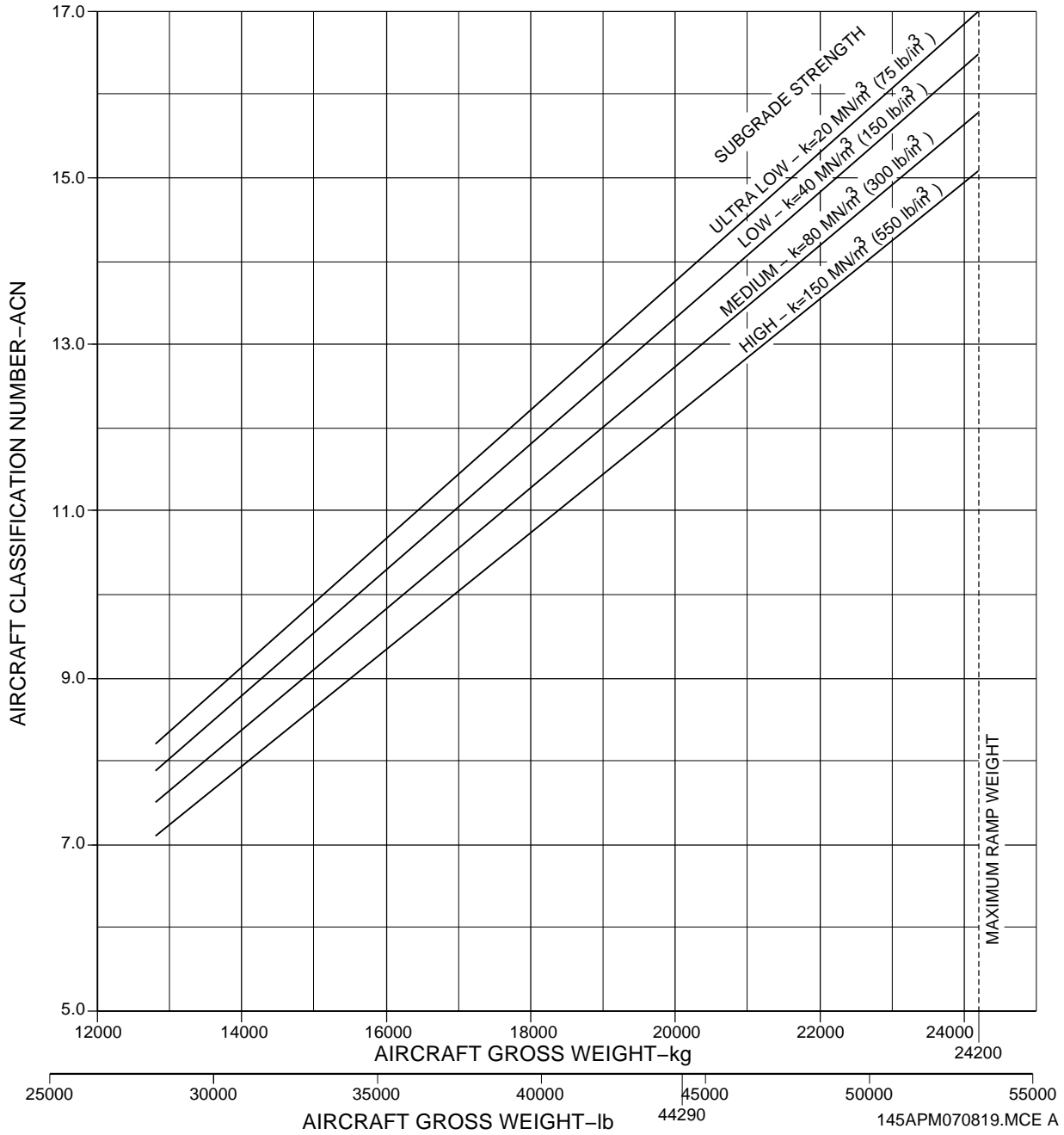
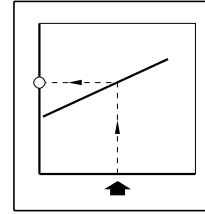


**Figure 7.9.2 - Aircraft Classification Number Rigid Pavement
Sheet 6**

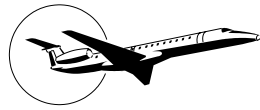


FLEXIBLE PAVEMENT SUBGRADE STRENGTH MODEL EMB-145 XR

- NOTES:**
- H30 x 9.5-16 16PR TIRES
 - TIRE PRESSURE 12,30 Kgf/cm² (175 psi)
 - % WEIGHT ON MAIN GEARS 93.47

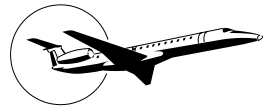


*Figure 7.9.2 - Aircraft Classification Number Rigid Pavement
Sheet 7*

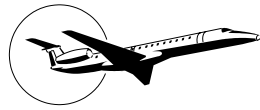


8. POSSIBLE EMB-145 DERIVATIVE AIRPLANES

No derivative versions of the EMB-145 are current planned.



THIS PAGE LEFT BLANK INTENTIONALLY



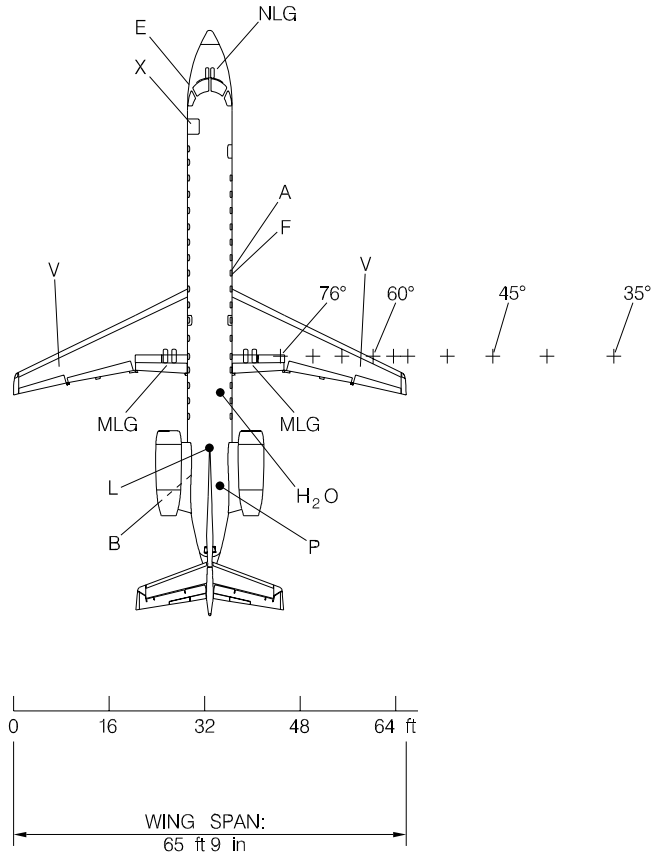
9. EMB-145 SCALE DRAWINGS

This section provides EMB-145 plan views to the following scales:

- English
 - 1 inch = 32 feet
 - 1 inch = 50 feet
 - 1 inch = 100 feet
- Metric
 - 1:500
 - 1:1000



9.1 EMB-145 Scale: 1 Inch Equals 32 Feet

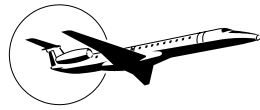


LEGEND:

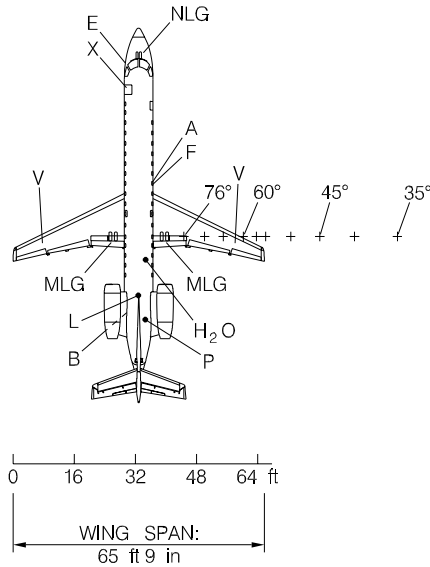
- A AIR CONDITIONING
- B BAGGAGE DOOR
- E ELECTRICAL
- F FUEL
- H₂O POTABLE WATER
- L LAVATORY
- MLG MAIN LANDING GEAR
- NLG NOSE LANDING GEAR
- P PNEUMATIC
- V FUEL VENT
- X PASSENGER DOOR
- + TURNING RADIUS POINTS:
76°, 70°, 65°, 60°, 57°, 55°, 50°, 45°, 40°, 35°

145AP046.MCE

Figure 9.1.1 - EMB-145 Scale: 1 Inch Equals 32 Feet



9.2 EMB-145 Scale: 1 Inch Equals 50 Feet

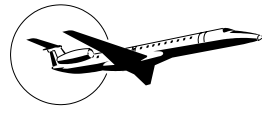


LEGEND:

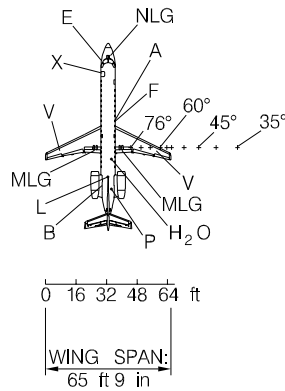
- A AIR CONDITIONING
- B BAGGAGE DOOR
- E ELECTRICAL
- F FUEL
- H₂O POTABLE WATER
- L LAVATORY
- MLG MAIN LANDING GEAR
- NLG NOSE LANDING GEAR
- P PNEUMATIC
- V FUEL VENT
- X PASSENGER DOOR
- + TURNING RADIUS POINTS:
 76°, 70°, 65°, 60°, 57°, 55°, 50°, 45°, 40°, 35°

145AP047.MCE

Figure 9.2.1 - EMB-145 Scale: 1 Inch Equals 50 Feet



9.3 EMB-145 Scale: 1 Inch Equals 100 Feet

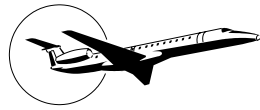


LEGEND:

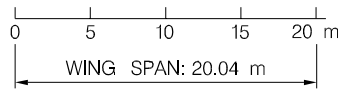
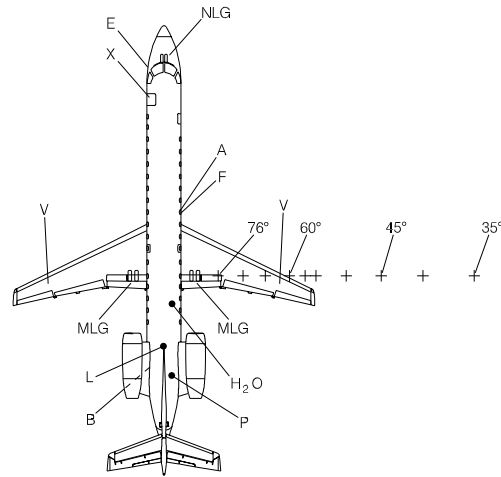
- A AIR CONDITIONING
- B BAGGAGE DOOR
- E ELECTRICAL
- F FUEL
- H₂O POTABLE WATER
- L LAVATORY
- MLG MAIN LANDING GEAR
- NLG NOSE LANDING GEAR
- P PNEUMATIC
- V FUEL VENT
- X PASSENGER DOOR
- + TURNING RADIUS POINTS:
76°, 70°, 65°, 60°, 57°, 55°, 50°, 45°, 40°, 35°

145AP048.MCE

Figure 9.3.1 - EMB-145 Scale: 1 Inch Equals 100 Feet



9.4 EMB-145 Scale: 1 to 500



LEGEND:

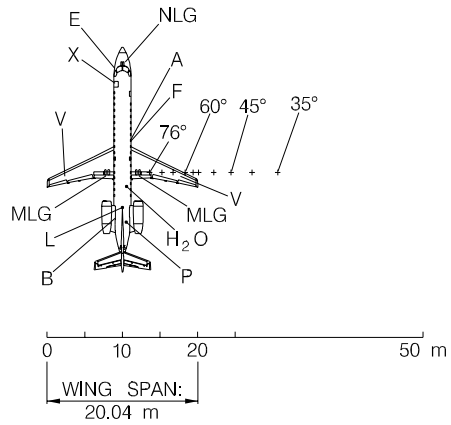
- A AIR CONDITIONING
- B BAGGAGE DOOR
- E ELECTRICAL
- F FUEL
- H₂O POTABLE WATER
- L LAVATORY
- MLG MAIN LANDING GEAR
- NLG NOSE LANDING GEAR
- P PNEUMATIC
- V FUEL VENT
- X PASSENGER DOOR
- + TURNING RADIUS POINTS:
 76°, 70°, 65°, 60°, 57°, 55°, 50°, 45°, 40°, 35°

145AP049.MCE

Figure 9.4.1 - EMB-145 Scale: 1 to 500



9.5 EMB-145 Scale: 1 to 1000



LEGEND:

- A AIR CONDITIONING
- B BAGGAGE DOOR
- E ELECTRICAL
- F FUEL
- H₂O POTABLE WATER
- L LAVATORY
- MLG MAIN LANDING GEAR
- NLG NOSE LANDING GEAR
- P PNEUMATIC
- V FUEL VENT
- X PASSENGER DOOR
- + TURNING RADIUS POINTS:
76°, 70°, 65°, 60°, 57°, 55°, 50°, 45°, 40°, 35°

145AP050.MCE

Figure 9.5.1 - EMB-145 Scale: 1 to 1000